

Crown Copyright Reserved

Post Office Engineering Department

**TECHNICAL PAMPHLETS
FOR WORKMEN**

Subject :

**Quadruplex, Quadruplex Repeated
Circuits and Telegraph Repeaters,
Simplex and Duplex.**

ENGINEER-IN-CHIEF'S OFFICE.

1919.

(Reprinted Nov. 1930, including Correction Slips to date)

(“ Jan. 1932, “ “ “ “)

(“ Mar. 1934, “ “ “ “)

LONDON

PRINTED AND PUBLISHED BY HIS MAJESTY'S STATNIONERY OFFICE

To be purchased directly from H.M. STATIONERY OFFICE at the following addresses :

Adastral House, Kingsway, London, W.C.2; 120, George Sreet Edinburgh 2

York Street, Manchester 1; St. Andrew's Crescent, Cardiff;

80 Chichester Street, Belfast;

or through any Bookseller

1936

Price 6d. Net

LIST OF Technical Pamphlets for Workmen.

GROUP A.

1. Magnetism and Electricity.
2. Primary Batteries.
3. Technical Terms.
4. Test Boards.
5. Protective Fittings.
6. Measuring and Testing Instruments.
7. Sensitivity of Apparatus.
8. Standard List of Terms and Definitions used in Telegraphy and Telephony. (*Not on Sale*)
9. Standard Graphical Symbols for Telegraphy, Telephony and Radio Communication. (*not on sale*)

GROUP B.

1. Elementary Principles of Telegraphy and Systems up to Morse Duplex.
2. Telegraph Concentrators.
3. Wheatstone System. Morse Keyboard Perforators.
4. Quadruplex, Quadruplex Repeated Circuits and Telegraph Repeaters, Simplex and Duplex.
5. Hughes Type-printing Telegraph.
6. Baudot Multiplex Type-printing System.
7. Western Electric Duplex Multiplex. Murray Duplex Multiplex. Siemens and Halske Automatic Type-printing System.
8. Fire Alarm Systems.

GROUP C.

1. Wireless Transmission and Reception.
2. Interference with Reception of Broadcasting.

GROUP D.

1. Elementary Principles of Telephony.
2. Telephone Transmission. "Loading." Telephone Repeaters and Thermionic Valves.
3. Principles of Telephone Exchange Signalling.
4. Magneto Exchanges - Non-Multiple Type.
5. Magneto Exchanges-Multiple Type.
6. C.B.S. No. 1 Exchanges-Non-Multiple Type.
7. C.B.S. Exchanges-Multiple Type.
8. C.B. Exchanges-No. 9 Type.
9. C.B. Exchanges-No. 10 Type.
10. C.B. Exchanges-No. 12 Type.
11. C.B. Exchanges-22 Volts.
12. C.B. Exchanges-40 Volts.
13. Trunk Telephone Exchanges.
14. Maintenance of Manual Telephone Exchanges.
15. Telephone Testing Equipment.
16. Routine Testing for Manual Telephone Exchanges.
17. Internal Cabling and Wiring.

[Continued on page iii of Cover.]

**Quadruplex, Quadruplex Repeated Circuits
and Telegraph Repeaters, Simplex and
Duplex.
(B.4).**

*The following pamphlets in this series are of
kindred interest:*

- A.1. Magnetism and Electricity
- B.1. Elementary Principles of Telegraphy and Systems up to Morse Duplex.
- B.3. Wheatstone System. Morse Keyboard perforators

CORRECTION SLIP TABLE

The month and year of issue is printed at the end of each amendment in the Correction Slips, and the number of the slip in which any particular amendment is issued can, therefore, be traced from the date. In the case of short corrections made in manuscript, the date of issue of the slip should be noted against the correction.

The Summary portions of the Correction Slips should be completed and affixed below in numerical order.

CORRECTION SLIP TABLE - (contd.)

The month and year of issue is printed at the end of each amendment in the Correction Slips, and the number of the slip in which any particular amendment is issued can, therefore, be traced from the date. In the case of short corrections made in manuscript, the date of issue of the slip should be noted against the correction.

The Summary portions of the Correction Slips should be completed and affixed below in numerical order.

Quadruplex, Quadruplex Repeated Circuits and Telegraph Repeaters, Simplex and Duplex.

TABLE OF CONTENTS.

Section A : Quadruplex	PAGE
1. MORSE QUADRUPLEX	5
2. QUADRUPLEX A SIDE, RELAYED SIMPLEX. (Morse Quadruplex A Side extended to C.B. Simplex line)	7
3. QUADRUPLEX A SIDE, RELAYED DUPLEX. (Morse Quadruplex A Side extended to Duplex Circuit) ...	9
4. SPLIT QUADRUPLEX REPEATER. (Morse Quadruplex A Side extended to A side of another Quadruplex)	10
5. FORKED QUADRUPLEX REPEATER. (Morse Quadruplex, A & B extended to two separate Duplex Circuits)	11
6. WHEATSTONE WORKING ON THE A-SIDE WITH VIBRATING RELAY, STANDARD G	14
Section B : Telegraph Repeaters, Simplex and Duplex.	
1. REASONS FOR USE OF REPEATERS	17
2. ARRANGEMENT OF APPARATUS	17
3. DUPLEX AND SIMPLEX REPEATERS	17
4. AUTOMATIC SWITCHES	17
5. PATHS OF CURRENTS THROUGH REPEATERS WHEN AT SIMPLEX	18
6. LEAK CIRCUITS FOR SIMPLEX WORKING... ..	21
7. DUPLEX CONNECTIONS	21
8. LEAK CIRCUITS FOR DUPLEX WORKING	22
9. FORKED REPEATERS	23

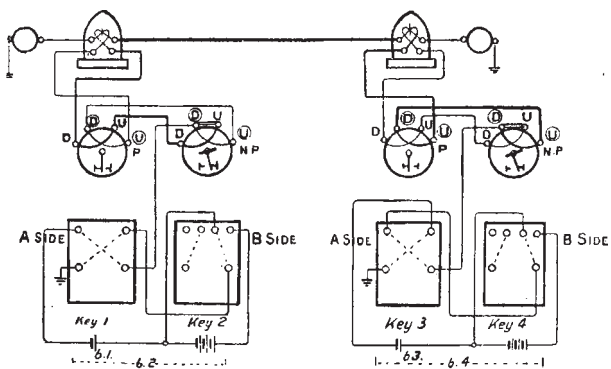

Fig. 1.

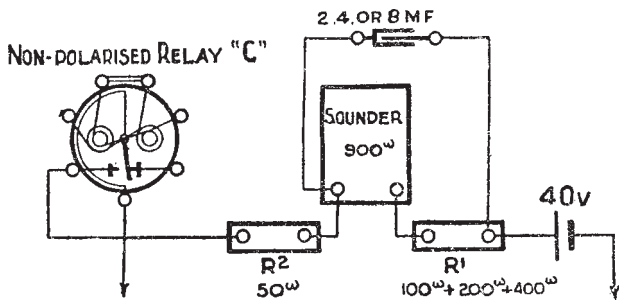

Fig. 2.

SECTION "A" : QUADRUPLEX

1. MORSE QUADRUPLEX.

Fig. 1 shows diagrammatically a line wire connected at each end to Quadruplex apparatus. P represents a Relay Standard B, the tongue of which closes the local circuit when a positive current flows in the direction from U to D or from (U) to (D)

From a scrutiny of the diagram, it will be apparent that if the B key remains at rest, that is, with the connections as shown in Fig. 1, and if the non-polarised relay NP be short-circuited, then the remaining circuit arrangement is a simple differential duplex set. Of the two coils of each Relay Standard B, one will be associated with the line circuit and the other with the compensation circuit. When, therefore, currents are flowing in both coils, the local circuit will be closed only when the difference between the two currents is such that the preponderance of one over the other results in a positive current either in the direction from U to D or from (U) to (D). In the case of the Relay Standard B, the strength of the current does not affect the local circuit; it is the direction of the preponderating current that determines the receipt of a signal.

The relay marked NP in Fig. 1 is a non-polarised relay. That is to say, the tongue will close the local circuit when currents, either positive or negative, are passed through the coils. The relay (with the coils joined in series) is connected to the terminals (D) and (U) of the Relay Standard B, and currents flowing through the latter will also flow through the non-polarised relay. If both relays are adjusted so as to respond to, say, 10 m.a. of current and signals are being sent, then relay P will respond only to the preponderating marking currents, whilst the local circuit of relay NP will remain permanently closed. The adjustments of the relay NP are such that by means of a spiral spring the tongue may be prevented from responding to the magnetic effect of currents passing through the coils. The extent to which this may be done is limited. Thus, in the case of a Relay NPC 100+100 ohms, the full tension of the spring will prevent the tongue responding to currents equivalent to that of values of less than 28 m.a. passing through one of the coils.

Suppose the relays are adjusted so that relay P responds to a current of 10 m.a. and relay NP responds to currents greater than 28 m.a., then Quadruplex working will be possible if the currents in the NP relay can be increased under the control of a separate key without affecting the apparatus at the sending end. From Fig. 1 it will be seen that the currents from the A side key pass through both the P and the NP relays differentially, and therefore the resultant magnetic effect on the armatures is nil. That is to say, the outgoing

currents do not affect the tongues of the relays. If, therefore, the connections between the battery and the A side key are made through the B key (Fig. 1), the desired result will be accomplished. That is to say, the relays P respond to positive currents in the direction U to D or (U) to (D), while the relays NP respond only to currents of a strength greater than that sent by the A side key.

The figure of merit tests provide for the P relays being adjusted to respond to currents as low as $\frac{1}{2}$ m.a. In practice the NP relays are adjusted by means of the spiral spring to respond to currents of about 3 times the value of those due to the A-side key

The actual adjustments will depend upon the nature of the line wire.

Where leakage is present, it may happen that only about 5 m.a. are received from the distant A side key and 15 m.a. from the B side key, in which case it will be necessary to adjust the tension on the spiral spring of the B relay, so that the smaller B side current may effectively close the local circuit.

The usual currents employed are 10 to 15 m.a. on the A side and 30 to 45 m.a. on the B side. The corresponding Galvanometer deflections are 30 to 35 divisions and 55 to 63 divisions respectively.

The need for careful adjustment of the A side key will be evident in considering the conditions when the distant B key is depressed for the duration of a dash while the A side key is sending dots. The A side key reverses the polarity of the battery, and if the adjustment of the key contacts is not sufficiently exact, the reversal of the magnetism in the coils of the non-polarised relay due to the reversals of polarity under the control of the sending A key is apt to permit of the momentary release of the armature. When such release occurs, the defect known as Split B side signals is encountered. The defect is also caused by high line capacity or low insulation resistance.

The tendency to split the B side signals cannot be entirely got rid of, but the arrangements shown in Fig. 2 partly compensate for this defect in quadruplex working.

In Fig. 2, R1 is an adjustable resistance coil (100+ 200 + 400 ohms) and R2 is a fixed resistance of 50 ohms. When a momentary break occurs in the circuit at the contact points of the relay, the condenser discharges itself through the sounder and the resistance R1. This discharge, together with the inductive effect produced by the coils of the sounder (which is such as to prolong the current beyond the instant when the circuit is broken), causes the magnetism to be retained in the cores of the sounder for a time sufficient to bridge the momentary disconnection.

With the ordinary quadruplex working a sounder is connected to the local contacts of the A side relay.

2. MORSE QUADRUPLIX A SIDE EXTENDED TO CB SIMPLEX.

In the simplest form of Quadruplex Repeater the local sounder on the A side relay is replaced by a Central Battery circuit. The arrangement is shown in Fig. 3, from which it will be seen that the line wire of the Central Battery Circuit is connected to the tongue of the A side Relay Standard B, and the Central Battery voltage is fed through a Relaying Sounder Polarised to the spacing contact of the A side relay, there being a feed resistance of 1,000 ohms in circuit with the battery.

When the Central Battery out-office key is depressed the line is earthed and the current from the 80 volts battery energises the Polarised Relaying Sounder, of which the spacing and marking contacts of the locals are "teed"

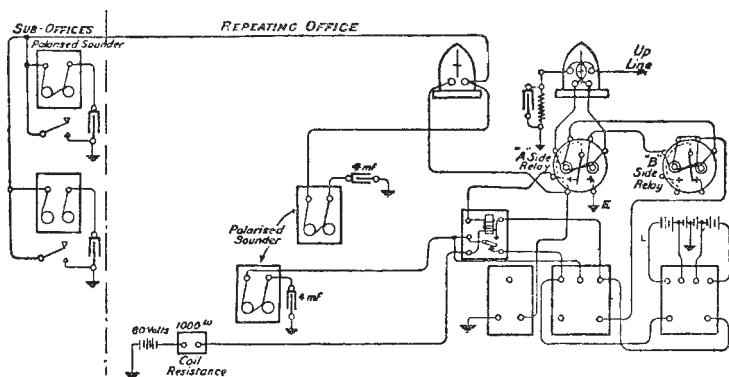

Fig. 3.

on to the battery terminals of the A side key of the Quadruplex set, whilst the tongue is connected to the middle top terminal of the A key. This will be clear from Fig. 3.

If, therefore, the A side key be put to "Receive," the tongue of the Polarised Relaying Sounder will be connected to the "Split" of the NP Relay and to the Quadruplex line.

When the Polarised Relaying Sounder is energised, the movement of the tongue from the spacing to the marking contact reverses the battery polarity on the Quadruplex line. The out office on the Central Battery circuit can by this means signal to the operator on the A side of the quadruplex at the distant station.

The method of signalling from the distant station operator to the Central Battery line will be apparent from a glance at Fig. 3. Normally, all the con-

condensers on the C.B. line are charged. The marking contact of the A side Relay Standard B is connected to earth. Each time the tongue is attracted to the marking stop, all the condensers on the C.B.S. line discharge through their respective Polarised Sounders.

The Polarised Relaying Sounder is connected to the spacing contact of the A side Relay Std. B, and therefore is disconnected when the tongue of the relay passes from the spacing contact to the earthed marking stop. The reason for this will be evident when it is remembered that the function of the Polarised Relaying Sounder is to take the place of the A key. That is to say, it is the equivalent of the A key worked under the control of the distant C.B. apparatus. If, therefore the movement of the tongue of the A side Relay did not effect the disconnection of the Sounder Relaying Polarised at the spacing

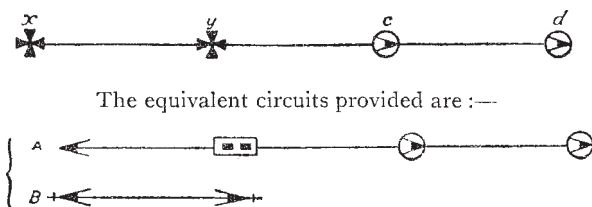

Fig. 4.

contact, the distant UP station operator would receive back, on the A side Sounder, signals sent by him on the A side key. The closest possible adjustment of the Sounder Relaying key is necessary in order to avoid the defect of Split B signals on the Quadruplex side occurring. Even with the best adjustment attainable the results cannot be so good as that obtained with a closely adjusted Key D.C. with adjustable contacts, by means of which a momentary short-circuit is given in the intermediate position of the key lever.

The reason for the use of two sounders Polarised on the C.B.S. line at the repeating office will now be clear; that on the local of the Polarised Relaying Sounder gives an indication that the signals from the C.B. line are being repeated to the Quad. line, whilst that on the Galvanometer of the C.B. line shows whether or not the A side Quadruplex signals are passing correctly to the C.B. system.

The service provided by this type of Quadruplex Repeater is represented by the symbols shown in Figure 4.

3. QUADRUPLEX A SIDE RELAYED DUPLEX.

The second type of Quadruplex Repeater to be described is that known as Quadruplex A side relayed Duplex. The arrangement is symbolised in Fig.



The equivalent circuits provided are:—



Fig. 5.

5 and the theoretical connections are shown in Fig. 6.

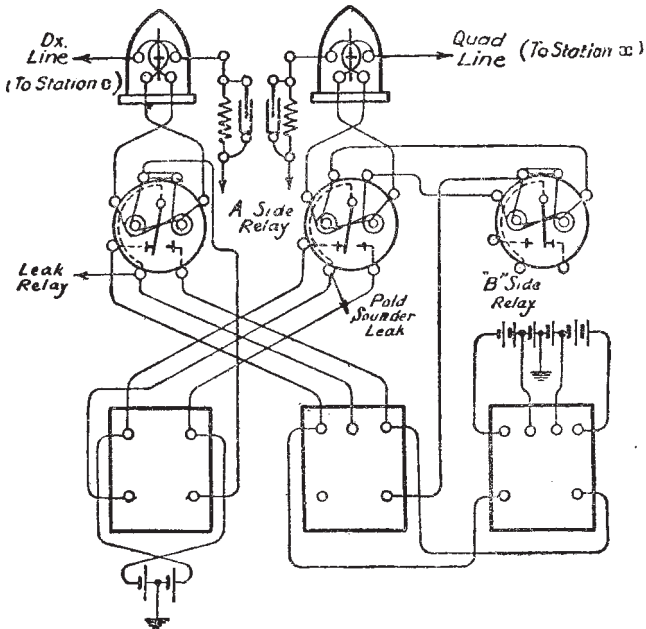

Fig. 6.

From what has been said regarding the Quadruplex A side relayed C.B.S., no difficulty will be experienced in understanding the principle. From Fig. 6 it will be seen the tongue of the A side Relay Standard B is extended to an

ordinary double current duplex set. The battery of the duplex set is connected to the spacing and marking contacts of the A side relay. With the key of the duplex set at "Receive" the tongue of the A side relay is connected to the split of the relay on the duplex set.

The battery on the duplex circuit is therefore controlled by the movement of the tongue of the A side relay, so that the distant station x Quadruplex operator can transmit signals to the distant station c on the duplex line.

Working in the other direction, it will be seen the arrangements are similar. The locals of the duplex circuit relay are "teed" to the A key (Fig. 6) and with the latter at "Receive" the tongue of the duplex relay is joined through

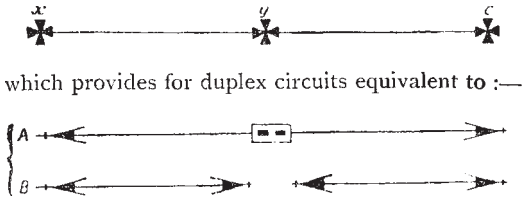

Fig. 7.

to the Quadruplex line. Thus the A side Quadruplex battery is controlled by the movement of the tongue of the relay on the duplex circuit. Leak relays, connected to the tongues of the transmitting relays, are provided for the purpose of observing whether the signals are passing satisfactorily in both directions.

4. SPLIT QUADRUPLEX REPEATER.

The third Quadruplex Repeater to be described is that designated as "Split Quadruplex Repeater." Fig. 7 shows that three duplex circuits are provided by means of the arrangement, viz., one duplex circuit between the repeating office and each of the terminal offices, and one duplex between the terminal offices. The latter circuit is obtained by relaying the A side.

Fig. 8 shows the repeating office connections in skeleton form.

Two full Quadruplex sets are placed side by side. The A side signals are repeated from one terminal station to the other by means of the tongues of the polarised relays connected to the A side keys as shown in the figure. At the A keys, the currents from the batteries at the repeating station are picked up by the tongues of the A relays.

When the B keys are worked they augment the currents which are being sent out by the A relays, thus the repeating station can work independently on

the B sides to stations X and Y while the two latter stations are in direct communication on the A side.

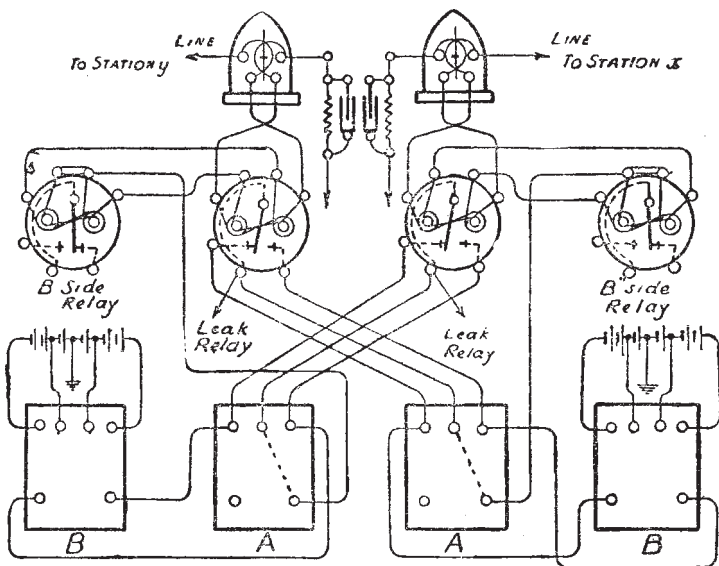

Fig. 8.

5. - FORKED QUADRUPLEX REPEATER.

The fourth and last Quadruplex Repeater to be described is that known

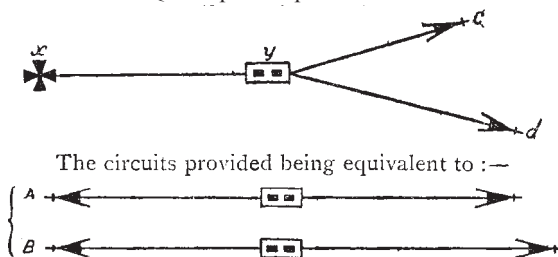

Fig. 9.

as "Forked Quadruplex Repeater," which is represented symbolically in Fig. 9. By this arrangement both A and B sides of the Quadruplex are relayed at y, so that with one Quadruplex set at x, duplex circuits to the two offices c and d are obtained.

The skeleton connections are shown in Fig. 10.

At the repeating office y the circuits connected to the terminal stations 1 and 2 (see Fig. 10) on the forked wires are terminated on duplex apparatus. The terminal station 3 on the main line (which is in communication with station 1 on the A side and with station 2 on the B side) is worked from a Quadruplex set.

When station 1 signals to station 3 the path of the currents is as follows:- From line 1 to the D terminal of relay R1 to the split of the relay, from which a negligible portion of the current passes to earth through a resistance shunted by a condenser connected to the terminal U of the relay; most of the current, however, passes from the split of the relay through K1 to the tongue and M or S terminal of relay R3, battery terminal of key K1 to battery B3 and earth. The tongue of the relay R1 is actuated and transmits positive or negative currents according to which of the contact stops it touches, to the split of the non-polarised relay R4 (through K4). At this point the currents divide, one portion passing through one half of the coils of relays R4 and R3, thence to station 3, the other portion going through the other coils of the relays R4 and R3, a resistance coil shunted by a condenser and the non-polarised "Observation" relay R6 to earth.

The currents due to the signals made when station 2 signals to station 3 pass through the apparatus at the repeating station as follows:-

From station 2 line to terminal D of relay R2, key K2, tongue of relay R3 and battery B4. Relay R2 is actuated and completes a circuit through the key K3 and two polarised relays, R7 and R8 (termed "incrementing relays") joined in series with each other and a resistance coil r_3 (1,500 ohms).

These incrementing relays are so adjusted that they act together as one instrument and perform the same function as a hand operated B-side key. (The armatures should be set neutral and each tongue should have the same amount of play.)

The tongues of these relays are connected to the A side key K4, and to the contact stops of the polarised relay R1 and the tongue of the latter relay sends out current to station 3, which is derived from the small (A side) Battery B2, or large (B side) battery, according to whether the tongues of the incrementing relays are touching their spacing or marking stops. The movements of the tongue of the polarised relay R2 therefore determine whether the B side non-polarised relay at station 3 shall be actuated or not.

Signals from station 3 for station 1 actuate the polarised relay R3, the tongue of which picks up positive or negative currents from its contact stops (which are teed to K1, to which a separate battery B3 is joined), and sends them out to station 1.

On the B side, station 3, in communicating with station 2, actuates the non-polarised relay R4, the tongue of which, when it moves to the marking stop, closes a circuit having a separate battery, B5, and the polarised transmitting relay R5. (This relay is joined in series with 50 ohms and 500 ohms coils, and is shunted by a condenser 8 mf. The arrangement is similar, and has a similar purpose, to that used for the prevention of the B side "kick.") The tongue of the transmitting relay picks up positive and negative currents

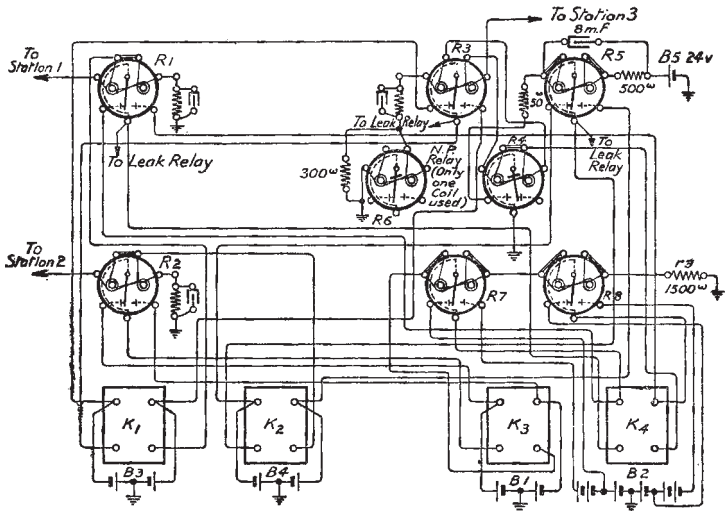

Fig. 10.

from its contact stops, which are teed to the key K2, the key being joined to a separate divided battery B4, and transmits these currents to station 2 in accordance with ordinary duplex methods.

As in the case of the A side relayed duplex arrangement, leak circuits are provided for observation purposes. They are connected to the tongues of the polarised relays R1, R3, R5.

A non-polarised relay, R6, is inserted in the compensation circuit of the quadruplex set in order that the repeated B side signals may be kept under observation. Only one coil of this relay is used, and this is shunted by a resistance of 300 ohms to reduce its sensitiveness. In this way it is ensured that the relay is operated only when good signals are being sent out by the incrementing relays.

6. - WHEATSTONE WORKING ON THE A-SIDE WITH VIBRATING RELAY, STANDARD G.

In one of the circuit arrangements an incrementing voltage which usually consists of a 30-volt battery is added both to the A and the B batteries.

Assuming an A voltage of 40 and a B voltage of 120, the following ratios will obtain with key and Wheatstone working respectively, viz. -

$$\text{Key working} = \frac{\text{B voltage}}{\text{A voltage}} = \frac{120}{40} = 3$$

$$\text{Wheatstone working} = \frac{\text{B}}{\text{A}} = \frac{120 + 30}{40 + 30} = 2 \frac{1}{7}.$$

In this case the reduction of the ratio B/A from 3 to 2 1/7 although not advantageous from the point of view of B-side working, tends to improve the Wheatstone signals.

In another wiring arrangement, the incrementing voltage is added to the B-side battery by the energising of an electromagnetic switch at the moment when the switch lever of the Wheatstone transmitter is turned on. The ratios B/A obtained under the two conditions previously mentioned are in this instance as follows, viz. :

$$\text{Key working B/A} = 3.$$

$$\text{Wheatstone working B/A} = \frac{120 + 30}{40 + 30} = 3.75$$

The increased ratio of B/A = 3.75 tends to maintain good working on the B-side when the transmitter is started on the A-side. There are, however, circuit conditions under which difficulty is experienced in obtaining good wheatstone working.

From the foregoing considerations, and also having regard to the fact that the circuit conditions referred to involve the use of voltages in excess of 120, it was decided to dispense with the use of incrementing voltages; and with the object of improving the working conditions for Morse Quadruplex, the wiring shown in Fig. 11 was adopted.

Where the line conditions are not too exacting it will be possible to obtain good Wheatstone working at 100 words per minute with voltages of 24 on the A-side and 80 on the B-side, by means of the vibrating relay, Standard G, wired as shown in the diagram. In other cases 40 and 120 volts can be used.

The main difficulty experienced with this type of installation is interference with the B-side signals caused by momentary out-of-balance conditions

of the circuit due to disconnections produced at the moment when the transmitter switch lever is turned and when the transmitter contact lever crosses from one side to the other between the contact stops. It is, therefore, advantageous that the transmitter starting lever be turned quickly and that the transit time of the contact lever be made as short as possible by ensuring that the contact screws are adjusted as closely as practicable without incurring the danger of short circuiting.

With a Wheatstone transmitter accurately and closely adjusted the increase in resistance in the circuit due to the motion of the contact lever between the contact stops should be not greatly in excess of 40 ohms.

Provision is made for balancing this resistance by means of a Coil, Retardation, 10-plug, having a resistance range from 1 ohm to 320 ohms. The function of the coil is briefly as follows:- With no resistance in the coils at each end an approximate balance is obtained to the distant station who is then requested to give "R" and at the same time run his transmitter. When capacity and resistance balances have been obtained the distant station should be asked to give "R" without running the transmitter. The circuit will now be out of balance and the distant station should be asked to insert resistance in the Coil Retardation 10-plug until the balance is again good.

SECTION "B" : TELEGRAPH REPEATERS, SIMPLEX AND DUPLEX.

1. REASONS FOR THE USE OF REPEATERS.

By the insertion of a Repeater on a long Telegraph line the speed and reliability of working is greatly improved. Its introduction into a circuit divides the line into two distinct sections, and the speed of working is increased practically to that of the longer or more difficult of the two sections.

2. ARRANGEMENT OF APPARATUS.

The repeating apparatus is so arranged that the currents from the terminal stations complete their paths through the relays at the repeating office, and, as a result of the actuation of the relays, fresh currents are sent out from the repeating office to the distant stations.

3. DUPLEX AND SIMPLEX REPEATERS.

The combined "Duplex and Simplex" form of Repeater is now the standard type. The connections of the instruments are so arranged that either Duplex or Simplex working between the terminals may be readily provided for at the repeater office. For Duplex working some boards are fitted on the differential principle on both sides, other boards are arranged for differential duplex on one side and for bridge duplex on the other. The latest development is arranged for "Universal" working, that is, to receive and send negative currents for marking, and positive currents for spacing on both sides, and also with either differential or bridge duplex conditions available on both sides.

Figure 1 gives the simplex connections on a board arranged for differential duplex on the "Up" side, and for bridge duplex on the "Down" side.

P.O. Standard B Relays are generally used for transmitting purposes.

The neutral Relays are the P.O. Standard neutral B type.

The two keys are "Keys S.C. with Switch," and these are provided to allow the repeater clerk to communicate with the terminal offices.

4. AUTOMATIC SWITCHES.

It is necessary to provide means by which the functions of the Switch of the Double current key at the terminal offices can be carried out automatically on the repeater board. For this purpose two automatic switches, or, more properly, Switches Electro-Magnetic, are provided.

It will be seen from Figure 1 that the local circuit through the auto-switches is normally disconnected, owing to the central position of the controlling relay tongue, but it is completed when currents pass through the relay and

cause the tongue to move over to the S or M contact. The coils of the Auto-switches are provided with a shunt which renders them sluggish in action, so that they remain closed during the momentary disconnection when the tongue of the relay passes over from one contact to another. In the diagram the levers of the "Up" auto-switch are shown in the position they occupy when the "Up" neutral relay is actuated by the incoming current.

5. PATHS OF CURRENTS THROUGH THE REPEATERS WHEN AT SIMPLEX.

Tracing now the path of an incoming positive current from the "Up" station, i.e., a " marking " current, it will be seen that the current passes through one coil of the "Up" galvanometer, across the "Up" key, to the right-hand lever of the "Down" auto-switch, then in a " marking " direction through the "Up" transmitting relay, through the rheostat, and "Up" neutral relay to earth. As already explained, the "Up" neutral relay has closed the "Up" auto-switch, and, as the tongue of the "Up" transmitting relay is now against the contact M, a positive current will pass from the

"Up" main battery via the tongue of the "Up" transmitting relay to the "Up" auto-switch, and by the right-hand side lever across the "Down" key, through one coil of the "Down" galvanometer, and so on to the distant "Down" station.

With the reversal of the "Up" station's current, it will be readily followed that the "Up" auto-switch will remain closed, and as the "Up" transmitting relay tongue will then be against the contact on the spacing side, a current in the reverse direction will be sent out from the "Up" main battery.

It should be clearly understood that the "Up" main battery sends current to the "Down" station, and that the "Down" main battery works to the "Up" station.

The "Up" rheostat and condenser for the duplex balance are available for use in fast-speed simplex working, as the rheostat is arranged as a shunt across the condenser.

In receiving from the "Down" station, the paths of the spacing and marking currents can be similarly traced. It will be noticed that the "Down" main batteries are reversed as compared with the "Up" main batteries to meet the condition that a "Down" office sends out a negative current for marking and a positive current for spacing.

The "Down" station's current passes through the Reading condenser and shunt, in addition to passing through the rheostat and condenser, for the duplex balance. The latter are therefore available if required, but under normal conditions the Reading condenser and shunt are adjusted to give the best

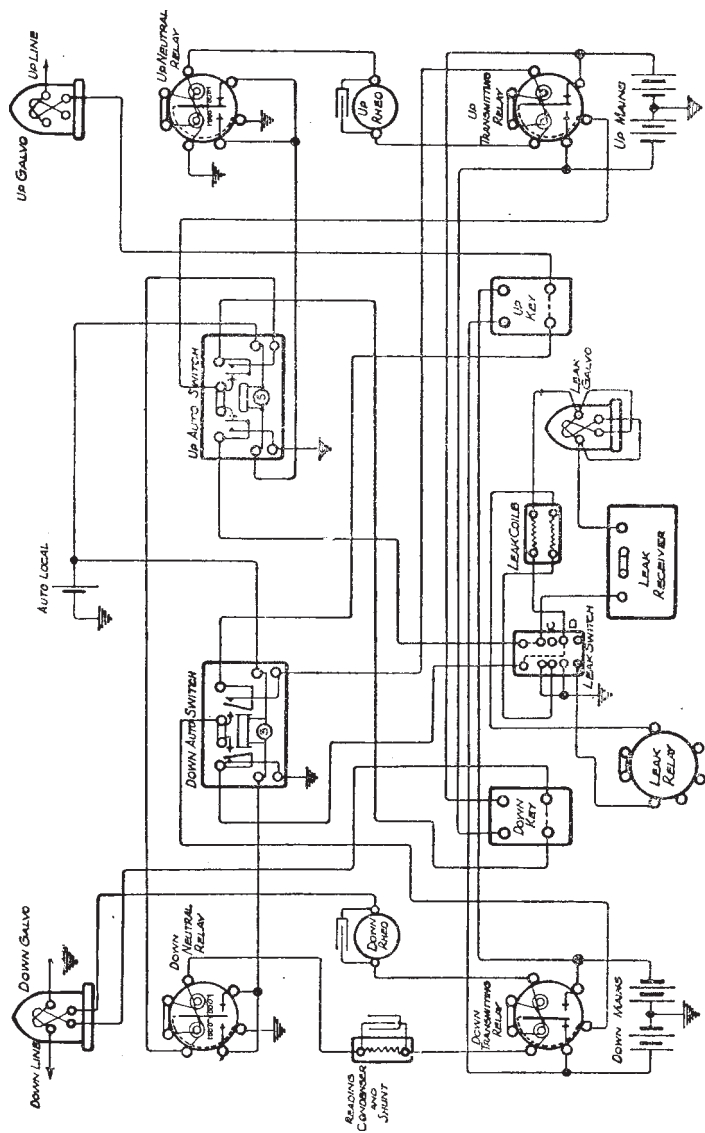

Fig. I

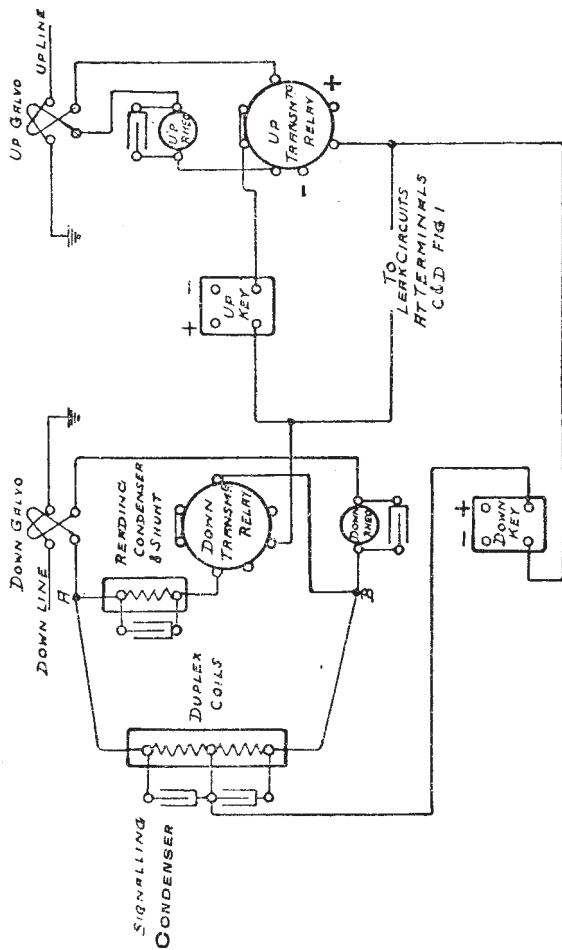

Fig. 2.

conditions for fast speed simplex working, and the resistance is taken out of the rheostat so that the balancing condenser is short-circuited and becomes inoperative.

6. LEAK CIRCUITS FOR SIMPLEX WORKING.

It is necessary that the repeater attendant should be able to observe the condition of the currents sent out to the distant stations and to speak to either side independently. For this purpose the left-hand levers of the auto-switches are utilised to provide two leak circuits through high resistances, so that only sufficient current may be taken to actuate in one case a Wheatstone Receiver and in the other a Relay. This is shown in Fig. 1. When the current is being sent to the "Down" station under simplex conditions, it will be seen that another path occurs at the left-hand lever of the "Up" auto-switch through the Leak switch, Wheatstone Receiver, Galvanometer Leak Coils, and then by the left-hand lever of the "Down" auto-switch to earth, completing the circuit of the "Up" main battery. The Wheatstone Receiver is therefore actuated by the currents sent out from the "Up" transmitting relay. Similarly the currents from the "Down" transmitting relay actuate the Receiver finding earth at the "Up" auto-switch. A galvanometer is inserted in the Leak Circuit, so that the condition of the currents sent out can be observed and any failures readily detected. The Leak coils consist of two sets of adjustable coils in steps of 5,000 ohms up to 20,000 ohms each, with the Wheatstone Receiver in one circuit and one set of coils and a Relay Standard B in the other. Both the Receiver and Relay Standard B have local sounder circuits. The change over from the Wheatstone Receiver to the Relay Standard B is made by means of the Leak Switch.

When either key is operated at the repeater, the conditions become that of a "Down" station speaking to an "Up" station or an "Up" station speaking to a "Down" station, according to which key is used.

It will be seen that the auto-switches are likely to be the most frequent cause of a disconnection so far as the repeater is concerned, as the right-hand levers of the auto-switches are in the line circuit, and it is necessary to pay particular attention to these contact points.

7. DUPLEX CONNECTIONS.

Fig. 2 is a skeleton diagram illustrating the conditions for duplex working on the same board as dealt with in Fig. 1, and by transposing the connections to suit there should be no difficulty in tracing the currents on boards arranged for differential duplex on both sides or for bridge duplex on both sides.

In duplex working the neutral relays and auto-switches are not required, consequently arrangements are made to cut these out of circuit by means of an 8-bar switch.

The main battery connections remain the same as in Fig. 1, and are omitted for clearness.

Differential duplex working is shown for the "Up" station. The outgoing current from the "Down" mains, according to the position of the "Down" transmitting relay tongue, divides equally and in opposite directions through the "Up" transmitting relay; similarly, through the "Up" galvanometer to the "Up" line and earth respectively when a proper duplex balance has been obtained. Consequently, the "Up" transmitting relay responds to the incoming currents from the "Up" station, which find their way to earth through the tongue of the "Down" transmitting relay and "Down" main batteries. Tracing a repeated positive current from the "Up" station, the tongue of the "Up" transmitting relay will be on the "M" side contact, and a current will pass out from the positive of the "Up" main battery across the "Down" key to

the middle point of the duplex coils (3,000+3,000 ohms). Presupposing that a duplex balance has been obtained, the current divides equally, one part going through one coil of the duplex coils, through one coil of the "Down" galvanometer to cable, while the other part goes through the "Down" rheostat and the other coil of the "Down" galvanometer to earth. As a result, the points A and B will be at equal potentials, and no current will flow through the "Down" transmitting relay. Current is, however, being received from the "Down" station, and this is affecting the potentials of the points A and B, so that if a "marking" current is being received from the "Down" station the point B will be at a higher potential than the point A, and a current will flow through the "Down" transmitting relay, causing the tongue to come over to the "M" contact, and this of course determines the direction of the current repeated to the "Up" station. The reading condenser and shunt are in series with the "Down" transmitting relay coils, and by suitable adjustment these give a much higher Wheatstone speed than would be possible without them.

8. LEAK CIRCUITS FOR DUPLEX WORKING.

In duplex working the repeater clerk is able to observe the signals sent out from the repeater to both terminal stations by means of two leak circuits arranged as taps from the tongues of the "Up" and "Down" transmitting relays. By means of the Leak Switch, the Receiver may be put in the "Up" leak and the relay in the "Down," or the conditions may be reversed.

9. FORKED REPEATERS.

The forked "News" Repeater with reversible leak is for use on a simplex circuit with two "Down" lines "forked" on one side of the repeater. With an ordinary Repeater the "Down" offices could correctly send and receive signals from the "Up" station, but they would be reversed to each other. This type of repeater is arranged to reverse the direction of the repeated signals from one "Down" office to another "Down" office, and under these conditions the signals from any one office are correctly received at all other offices.

LIST OF

Technical Pamphlets for Workmen.

(Continued)

GROUP D - continued.

18. Distribution Cases, M.D.F. and I.D.F.
19. Cord Repairs.
20. Superposed Circuits. Transformers. Bridging Coils and Retardation Coils.
21. Call Offices.
22. Units Amplifying (*Not on sale*)

GROUP E.

1. Automatic Telephony: Step by Step Systems.
2. Automatic Telephony:- Coder Call Indicator (C.C.I.) Working.
3. Automatic Telephony: Keysending "B" positions.

GROUP F.

1. Subscribers' Apparatus. Common Battery System.
2. Subscribers' Apparatus. C.B.S. Part I-C.B.S. No. I System.
3. Subscribers' Apparatus, Magneto.
4. Private Branch Exchanges-Common Battery System.
5. Private Branch Exchanges--C.B. Multiple, No. 9.
6. Private Branch Exchanges - Magneto
7. House Telephones.
8. Wiring of Subscribers' Premises.

GROUP G.

1. Maintenance of Secondary Cells.
2. Power Plant for Telegraph and Telephone Purposes.
3. Maintenance of Power Plant for Telegraph and Telephone Purposes.
4. Telegraph Battery Power Distribution Boards.

GROUP H.

1. Open Line Construction, Part I.
2. Open Line Construction, Part II.
3. Open Line Maintenance.
4. Underground Construction, Part I - Conduits.
5. Underground Construction, Part II - Cables.
6. Underground Maintenance.
7. Cable Balancing.
8. Power Circuit Guarding.
9. Electrolytic Action on Cable Sheaths, etc.
10. Constants of Conductors used for Telegraph and Telephone Purposes.

GROUP I.

1. Submarine Cables.

GROUP K.

1. Electric Lighting.
2. Lifts.
3. Heating Systems.
4. Pneumatic Tube Systems.
5. Gas and Petrol Engines.