

# WESTERN ELECTRIC DUPLEX MULTIPLEX AND OTHER SYSTEMS. (B.7.)

---

*The following pamphlets in this series are of  
kindred interest:*

- B.1. Elementary Principles of Telegraphy and Systems**
- B.3. Wheatstone, Morse Keyboard Perforators**
- B.5. Hughes' Type-printing Telegraph.**
- B.6. Baudot Multiplex.**

*The following is also of interest*

**I.P.O.E.,E. Journal. Vol. 8, No. 3.**  
**"A new Type-printing Multiplex Telegraph,"**  
**By A. H, Roberts.**

---

## TABLE OF CONTENTS.

	PAGE
<b>WESTERN ELECTRIC DUPLEX MULTIPLEX</b>	
PRINCIPLE ... ..	2
CODE ... ..	2
<b>APPARATUS</b>	
DISTRIBUTOR ... ..	3
KEYBOARD PERFORATOR ... ..	11
AUTOMATIC TRANSMITTER ... ..	14
AUTO-CONTROL SWITCH ... ..	17
PRINTER ... ..	19
DIVIDED CIRCUITS ... ..	21
TRAFFIC CAPABILITIFS ... ..	23
<b>THE MURRAY DUPLEX MULTIPLEX TYPE-PRINTING</b>	
TELEGRAPH SYSTEM ... ..	23
<b>THE SIEMENS &amp; HALSKE AUTOMATIC TYPE-PRINTING</b>	
TELEGRAPH SYSTEM ... ..	23

# WESTERN ELECTRIC DUPLEX MULTIPLEX AND OTHER SYSTEMS.

## PRINCIPLE.

The principle of the Western Electric Duplex. Multiplex System is similar to that of the Baudot Duplex in that a fiveunit code is adopted for the Alphabet, and Distributors are used one at each end of a circuit. The differences are in details, such as the use of **Keyboard Perforators** and

ALPHABET FOR WESTERN ELECTRIC MX.						
A	-	---	<sup>FH</sup> 2 1	Q	1	·5 - 3 <sup>FH</sup> 2 1
B	P	5 4	-●-1	R	4	- 4 -●2 -
C	⋮	- 4 3	●2 -	S	THR	- - 3 ●- 1
D	\$	- 4	-●-1	T	5	5 - -●- -
E	3	- - -	●- 1	U	7	- - 3 ●2 1
F	any	- 4 3	●- 1	V	9	5 4 3 ●2 -
G	&	5 4	-●2 -	W	2	5 - -●2 1
H	£	5 - 3	●- -	X	/	5 4 3 ●- 1
I	8	- - 3	●2 -	Y	6	5 - 3 ●- 1
J	'	- 4	-●2 1	Z	7	5 - -●- 1
K	(	- 4 3	●2 1	Letters		5 4 3 ●2 1
L	)	5 - -	●2 -	Figures		5 4 -●2 1
M	•	5 4 3	●- -	Car. Ret.		- 4 -●- -
N	,	- 4 3	●- -	Space		- - 3 ●- -
O	9	5 4	-●- -	Line Feed		- - -●2 -
P	0	5 - 3	●2 -	Blank.		- - -●- -

Fig 1.

**Automatic Transmitters** instead of *Direct-sending five-finger Keyboards* for sending the combinations of current impulses to line, and in the use of column printers instead of *slip printers* for the reception of signals. **The method of maintaining the Phase relationship** between the Distributor Brushes at the two Stations, which will be referred to again later, also differs from that of the Baudot, but is a development of the Picard correction used on some Baudot circuits in France.

## CODE:

The code used for the Western Electric Multiplex, although a five-unit one, is not arranged in the same order as the Baudot. It is shown in Fig. 1.

## APPARATUS.

The apparatus at each office consists of a distributor, four keyboard perforators, four automatic transmitters, four automatic control switches, and four printers. There are also spare instruments for changing purposes, and as all the main connections are made by spring clips the time occupied in changing a faulty piece of apparatus is reduced to a minimum.

The distributor table accommodates the Post Office standard relays, adjustable condensers, resistance coils, and switches; but fixed resistances,

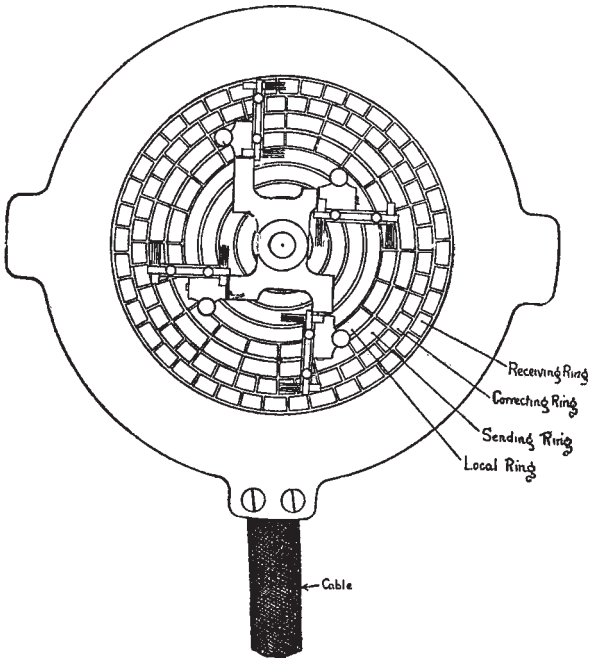

Fig 2.

condensers, and the connecting plugs of the distributor are contained in an iron case which is carried underneath the back of the table.

**The distributor** is driven by a phonic wheel motor, and has its face divided into eight rings, the four outer being subdivided into segments, while the inner four are of solid metal. A brush holder, which is clipped to the spindle of the motor, carries four pairs of brushes, each pair forming the connection between one of the solid rings and one of the segmented rings (Fig. 2).

The *outer circle* is the receiving ring and consists of forty segments; alternate segments only are utilised for the received signals, the intermediate segments being used to give a flash on a small electric lamp, fixed inside the case. of the printer, to indicate to the operator that signals are passing.

The plugs which connect the permanent wiring of the tables to the distributor permit of adjustment within certain limits to allow for line retardation; the receiving ring of the distributor may also be independently moved to refine this adjustment and to ensure that the receiving segments are correctly placed.

The *second ring* is for the purpose of correcting the speed of . the motor, and is used at one end of the line only.

The *third ring* of the distributor has its twenty segments, divided between the four transmitters, and is known as the *sending ring*. Each quadrant of the ring serves one arm of the multiplex; the five segments of one quadrant are, therefore, joined to the five contacts of a transmitter. One of the pair of brushes allotted for sending is connected through a solid ring to the "split" of the line relay (Fig. 3), while the other sweeps over the segments and thus joins each in turn to the line and compensation circuits in the usual differential duplex manner. The portion of the current passing to line actuates a polarised relay at the receiving station, which repeats the received currents through the common receiving ring, brushes and segments to the selecting relays of the printer served by the particular set of segments concerned in the operation (Fig. 4)

The *fourth segmental ring* is known as the "local." Its function is to complete the actual printing of the selected signal, release the relays and move the paper forward in readiness to receive another signal from line. The local ring also controls the movement of the perforated paper slip through the transmitter as explained later.

The Western Electric Multiplex is being worked as a quadruple duplex on an underground loop circuit in the cable between London and Manchester, at a speed of 40 words per minute for each channel. Manchester is the correcting office and London the corrected office. For this reason the Manchester motor is run at a slightly faster rate

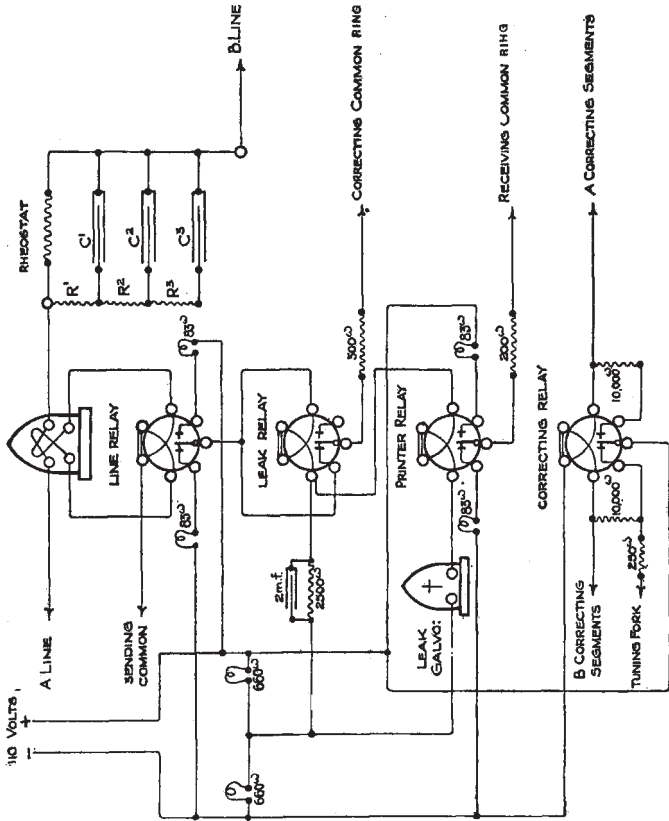

Fig. 3.

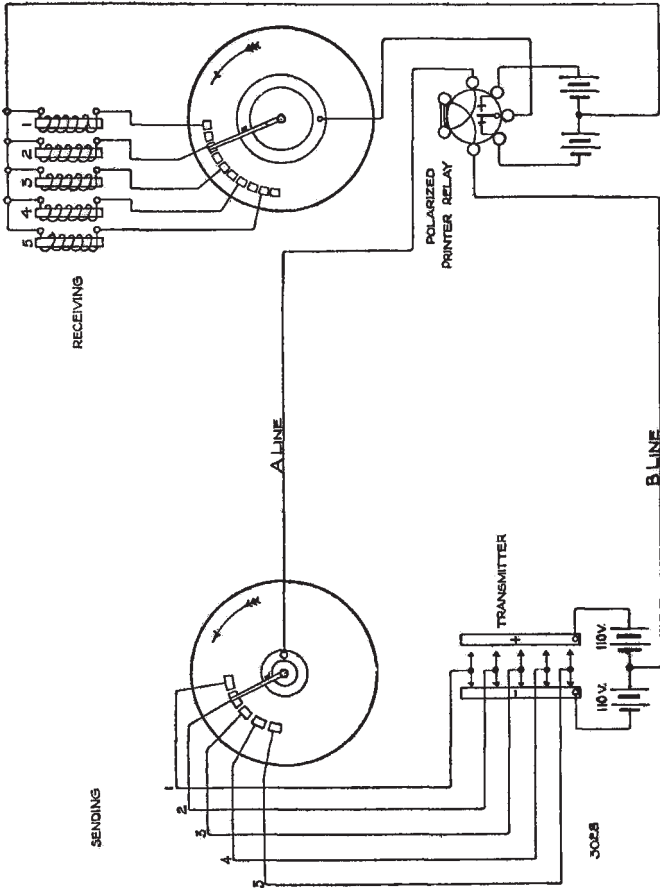

Fig. 4.

than the London motor. The speed of the motors is controlled by the action of electrically vibrated tuning forks, the frequency of vibration being regulated by the attachment of weights near the ends of the prongs. For smaller variations than could be met by moving the weights, a second short fork is made to slide up or down the inner sides of the vibrating prongs. by a screw action worked by a rotary

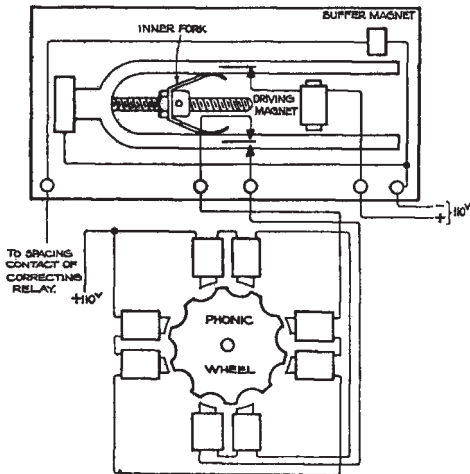

Fig 5.

handle fitted in the base, of the instrument. The small fork presses against the sides of the vibrating prongs and governs

the effective length of the large fork. By means of spring contacts the vibrating fork rapidly completes and disconnects the electrical circuit through the ails of the motor. Fig. 5 shows the connections of the Tuning Fork.

It has already been stated that the London motor is purposely run a shade slower than that at Manchester, but before the loss of speed at the London end reaches the point at which it would interfere with the working, correction takes place by means of a rubber-tipped buffer striking the vibrating fork, momentarily increasing the rate of vibration

and preventing the motor from running out of phase. The buffer rod is operated by the armature of a buffer magnet which is controlled by the incoming correcting impulses.

It is a feature of the system that correction is brought about by the working line signals, no special segments on the sending and receiving rings being appropriated to this purpose. Consequently there is no loss of valuable line time in securing correction.

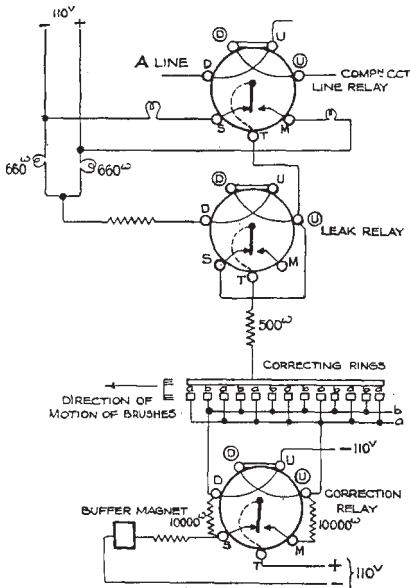

Fig 6.

**Method of Correction.**-Fig. 6 shows, diagrammatically, the connections of the various relays for correction purposes. As already stated, correction is brought about by the working line signals, it being arranged that a correcting impulse is generated only when the tongue of the Line Relay moves from the spacing to the marking contact.

The leak relay tongue follows the movements of the line relay tongue,

but with a time lag, so that, when the line relay tongue goes over to marking, an instantaneous current passes from +110v, M of line relay, Line Relay tongue (U) of leak Relay, S and T of Leak relay to the correcting ring; brushes, D to U or O to (D) of correcting Relay, according to whether the Brush is on a "b" or "a" segment of the segmented correcting ring, to -110v.

If the Brush is on a "b" segment when the correction impulse is generated, the motor at the corrected station is running too slow. The current through the D to U coil of the correction relay places the tongue of the latter on the spacing stop and thereby actuates the buffer magnet. The rod of the buffer magnet is thus operated and limits the amplitude of the Fork. Its rate of vibration, and therefore the speed of the motor, is consequently increased. This increased speed is maintained until the brush is on an "a" segment when a correcting impulse is received. The resulting current through (U) to (D) coil of the correcting Relay brings the tongue of the latter over to the marking contact and breaks the Buffer magnet circuit, allowing the Fork to vibrate, at its normal amplitude with reduced speed. The two 10,000 ohm resistances shown, are in circuit for locking the correcting Relay in either position.

**Phase finding.**-It is necessary to provide a means of bringing the brushes of the two Distributors into Phase, otherwise they will continue to rotate out of step even though they are moving at exactly the same speed. The operation of bringing the brushes into step is known as Phase Finding, and is done as follows The correcting station stops the and and 3rd Transmitters, allowing the 1st and 4th to run without tape. In these circumstances, the 1st and and Transmitters will send all negative impulses to line and the 3rd and 4th Transmitters all positive impulses, so that only one correction impulse is sent out per revolution, viz., where the change occurs from positive to negative.

At the corrected station a switch is operated which joins up the segments of the correcting ring in such a manner as to form two com-

plete half rings (see Fig. 7). If the Brush on the correcting ring at the corrected station is on the A half of the ring when the correcting impulse comes in, the tongue of the correction relay moves to marking and the Buffer is not operated. This allows the Fork at the corrected station to vibrate at its normal speed and the brushes lose on those at the Correcting Station. This loss will persist until the brush on the correcting ring is

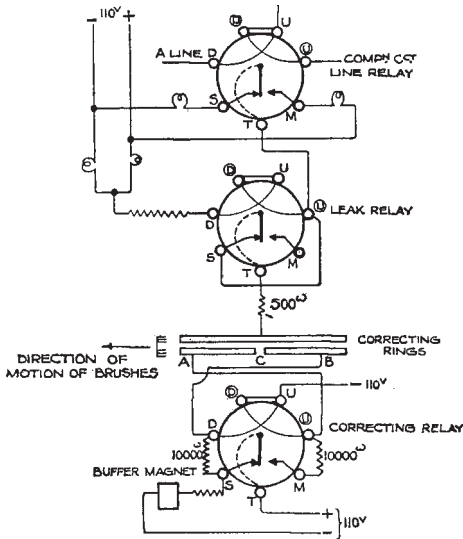

Fig 7.

at the point C when the correction arrives. The reverse happens if the Brush at the corrected station is on the B half of the ring. The tendency is, therefore, to bring the brushes into Phase at the point marked C, which is in such a position as to bring the Brushes at the two stations into their proper Phase Relationship for correct working. The operation of the Buffer magnet indicates when the Phase has been attained.

In a later form of the Western Electric Multiplex a slightly different method is adopted for Correction and Phase Finding. Each reversal of current is arranged to constitute a correcting impulse. At the Corrected Station the Correcting Relay, when operated, short-circuits a resistance which is in the circuit of the Fork-driving magnet and thus varies the speed of the Fork.

**Orientation.**-The process of refining the Phase relationship in order to get the Receiving ring into the best position for the reception of 'the incoming printing impulses is known as **Orientation**. To effect this the transmitters at the Distant Station are run without tape and are therefore sending marking impulses to line. The Receiving Ring of the Distributor is then moved slowly to the left until the letter K begins to print on any one or all of the four printers. The point at which this occurs is noted on the scale on the Distributor top. The operation is then reversed, the Receiving Ring being turned slowly to the right until letter V begins to print on one or all of the printers, and this position is also noted on the scale. The middle point between the two limits is the best position for the Receiving ring.

When this has been carried out test slips are run on each Channel in order to verify adjustments, and, if O.K. in both directions, the circuit is ready for traffic.

**The Keyboard Perforator** (Figs. 8 and g) consists of three rows of keys carrying primary and secondary symbols, the change from one to the other being effected by the depressions of " letter shift " and " figure shift " keys. The "touch" of the keys is light and the depth of travel small, so that the instrument may be worked for long periods without causing fatigue.

When a key is depressed the internal mechanism selects one or more of the punches, and at the end of the downward stroke an electrical circuit is closed which energises the perforating magnet and causes the selected punches to cut through the paper (see Fig. 10). The slip is perforated 'transversely and each combination of signals forming a letter requires a length of only one-tenth of an inch of slip. In the case of the

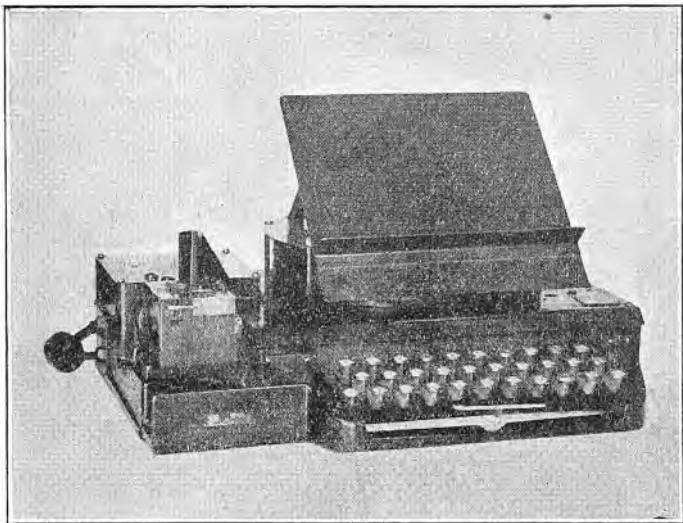

Fig 8.

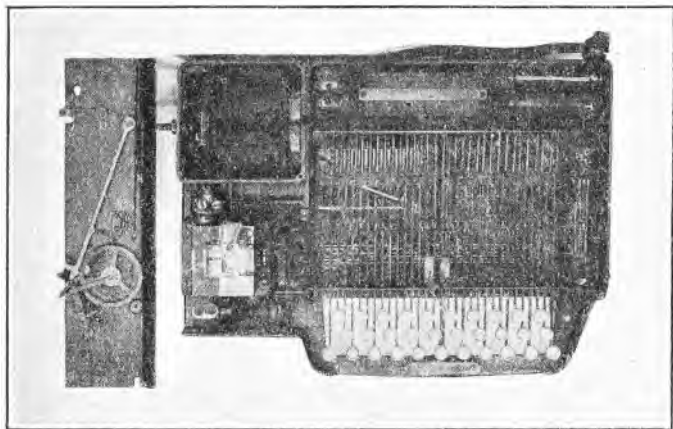

Fig 9.

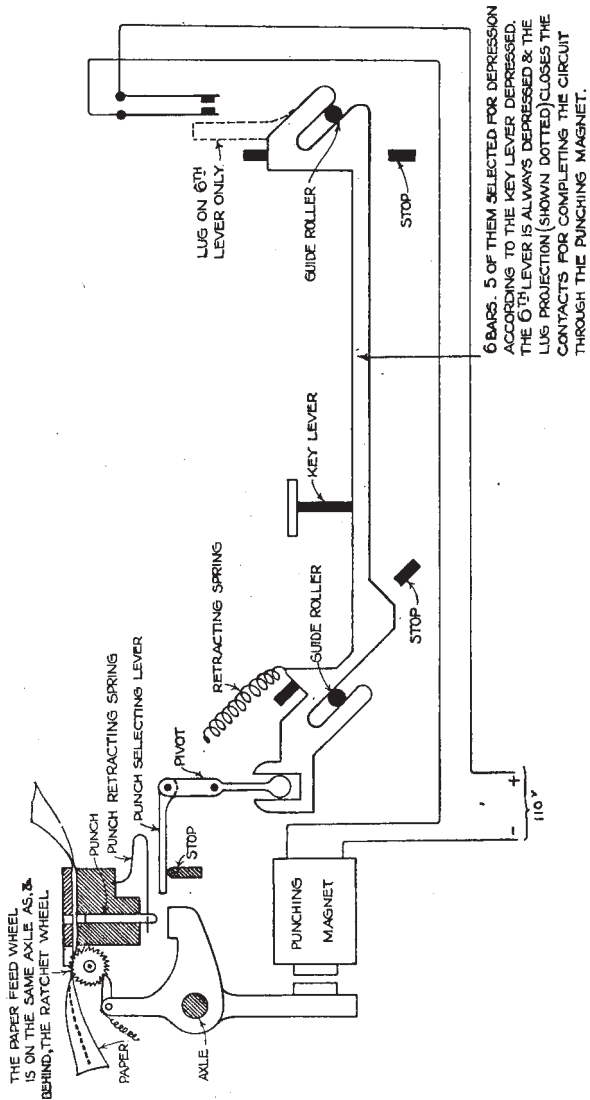

Fig. 10.

Wheatstone system the combinations of signals forming the letters are punched along the length of the slip. To illustrate the saving in paper by adopting cross punching, the words "Post Office Telegraphs" are shown perforated by the two methods, in Fig. 11.

Special signals are provided for "line feed" and "carriage return". The first of these causes the paper on the receiving printer to be stepped up for a new line, while the second draws the paper carriage to the right. In order that the keyboard operator may not punch too many words in one line, an indicator is fitted just above the keyboard to show the number

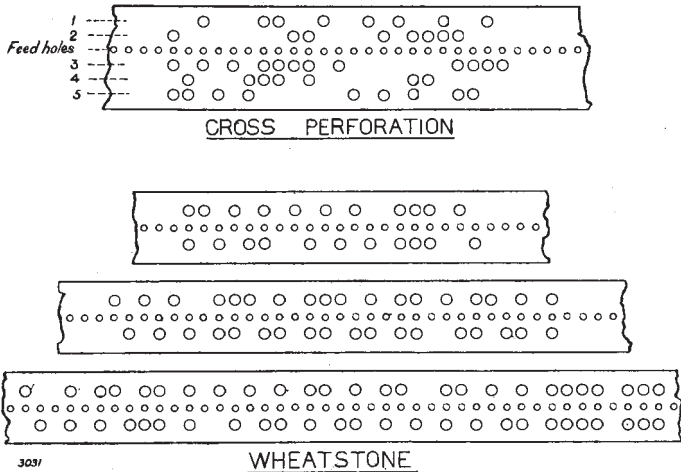

Fig 11.

of letters already punched, and as a further precaution a signal lamp fixed at the left front of the perforator glows when the maximum number of signals allowed for one line is approached. When this lamp lights up, the puncher depresses the "line feed" and "carriage return" keys in succession; this resets the pointer of the indicator at zero and extinguishes the lamp.

**The Automatic Transmitter** (Fig. 12).-The transmitter contains five movable contacts somewhat similar in character and purpose to the tongue of a telegraph standard relay. Each contact is connected, as already stated, to a separate segment in the same quadrant of the sending ring of the distributor. Normally, all the contacts or tongues rest against a bus bar joined to the spacing side of a double battery. On starting the transmitter the perforated slip is moved forward letter by letter by the action of a star

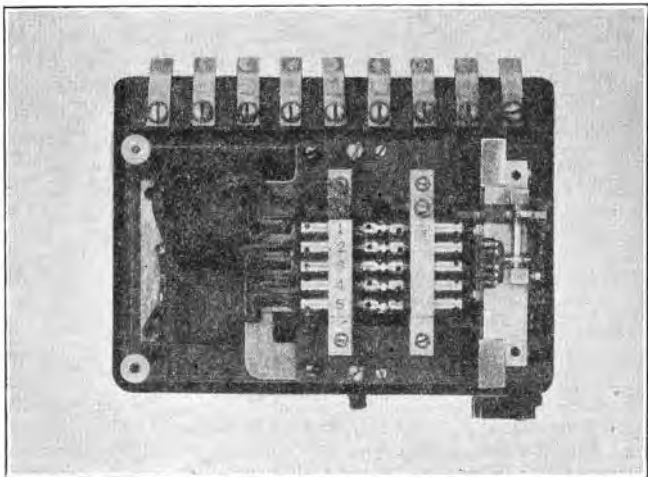
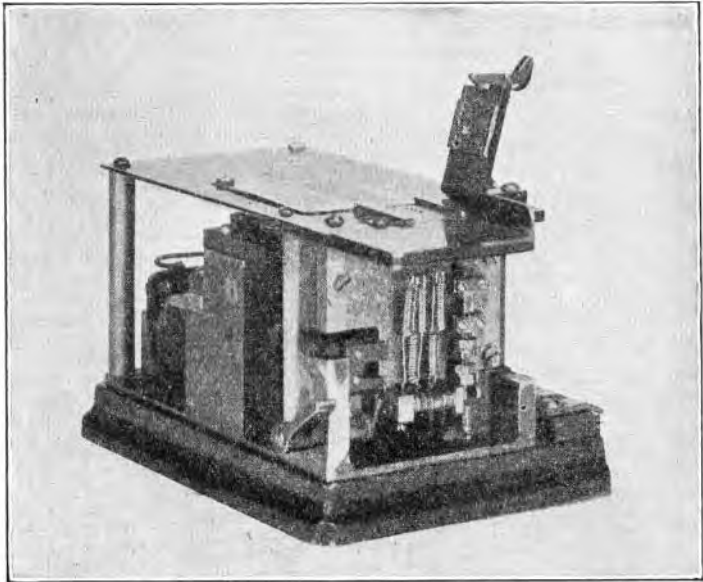

Fig 12.

wheel which engages with feed holes in the paper.

At each step one or more of the selecting rods rise through the perforations and cause the transmitter contacts which they control to pass over to the marking bus bar, the remaining rods not being free to rise retain their respective contacts on the spacing side.

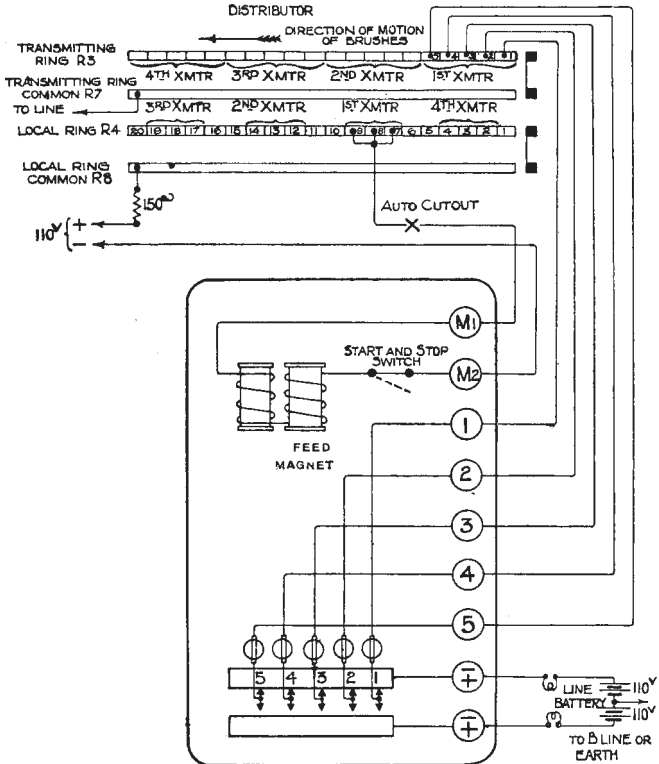

Fig 13.

For instance, to signal the letter "A," holes are punched in positions 1 and 2 (Fig. 11) and on the slips passing through the transmitter, rods 1 and 2 project through the holes and move contacts 1 and 2 to the marking side, while 3, 4 and 5 remain on the spacing bar. The sending brush of the distributor passing over each segment in turn connects it to line and causes the same combination of momentary currents to pass through the receiving relay at the distant end. Immediately the fifth sending segment of one

quadrant has been passed by the sending brush, a circuit is completed through the transmitter feed magnet and local rings of the distributor, for the purpose of feeding the paper forward and allowing the rods to set up the proper selection for the next letter during the time the sending brushes are passing over the segments of the other three quadrants.

In addition to the usual "start" and "stop" switch there is a second switch, marked "on" and "off" in the base of the instrument. If a piece of perforated slip is in the transmitter with the first switch at "start" and the second switch in the "off" position, the letter selected will be sent once for each revolution of the brushes, but the paper will not be moved forward, as the feed magnet will remain disconnected. This is found convenient during speed trials and for testing purposes.

For ordinary traffic the base switch must, of course, be in the "on" position.

Adjacent transmitters send currents of opposite polarity for marking. Thus, if instrument No. 1 sends negative marking, No. 2 will send positive marking, and so on. This causes frequent reversal of current and thus ensures the action of the correcting mechanism under all conditions. Fig. 13 shows the Transmitter Connections.

**Auto-control Switch.**-Between the keyboard perforator and the transmitter, an automatic switch is fitted to prevent the transmitter tearing the paper in the event of the slip being drawn tight through the transmitter overtaking the perforator.

A light metal arm projects from the switch, and underneath this the slip passes on its way to the transmitter. If tension for any reason be applied to the paper, the switch arm is raised and the Transmitter Feed Magnet circuit disconnected. At the same time the transmitter contacts are brought to the spacing bus bar, and for each revolution of the brushes spacing current only passes to line. A small electric lamp in the upper part of the instrument lights up to indicate to the operator that the slip has ceased running. When the tension on the paper is relaxed the arm drops and allows signals to be again transmitted.

The printer at the distant office, during the interval that spacing currents only are received, remains inactive. Even if the cessation occurs in the course of transmitting a word, the printer will pick up at the correct point and continue without leaving a gap to show where the transmitter

stopped. The internal connections of the Auto-Control Switch are shown in Fig. 14.

The latest form of Auto-Control embodies, in addition to the above function, a means of enabling the transmitting operator to send bell signals over the line. This is brought about by three cams, driven by an escapement mechanism, causing three contact springs to be opened and

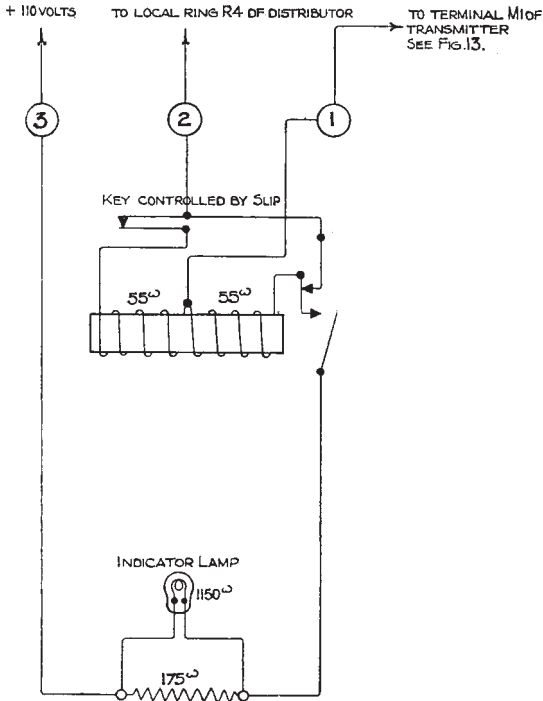

Fig 14.

closed in certain definite sequences. In order to ring the bell once at the distant station the operator inserts a finger in the hole marked " start " in the side lever, and pulls the latter down until the finger engages a stop. The lever is then released and is restored to its normal position, step by step, by means of the escapement mechanism which is operated by the armature of an electro-magnet controlled by the Transmitter Cadence Current. During the restoration of the lever to its normal position the

cams are rotated and the required contacts made to ring the bell once at the distant end. The operation of the lever stops and starts the Transmitter automatically, so that bell signals may be sent while a slip is passing through the Transmitter, without any danger of mutilating the message. The side lever is provided with five fingerholes, so that any number of rings up to five may be automatically transmitted over the line.

**The Printer** (Fig. 15),-The received currents, as already explained, are repeated through a P.O. standard relay and the common receiving ring to the receiving segments, each of which has a separate selecting relay in its circuit. As the brushes pass over the segment, selection takes place in the same sequence as the currents are sent out by the distant transmitter.

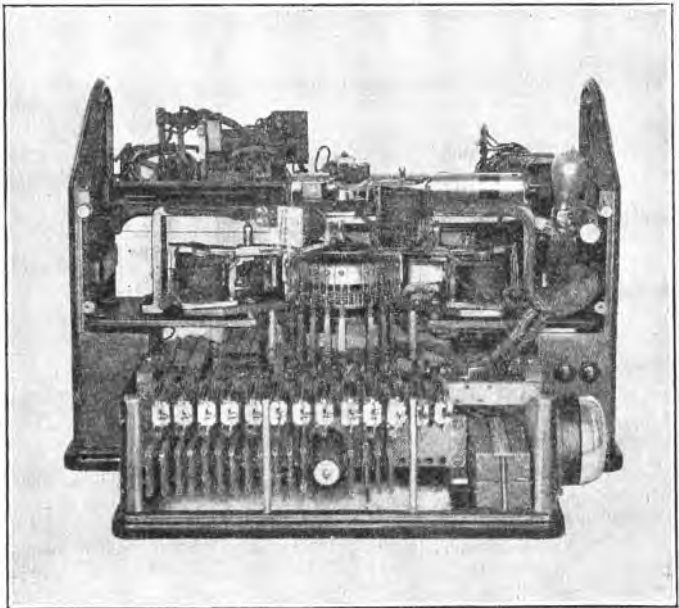

Fig 15.

The type-wheel of the printer is carried on a vertical spindle driven by a spring movement, a small electric motor being employed to maintain the necessary tension of the spring.

The printing of the correct symbol is brought about in the following manner :-A set of five skeleton discs, slotted at their outer edges and

capable of horizontal movement through a small angle, are arranged one above the other. Outside and surrounding the discs a number of levers, shaped like an inverted letter L and supported at their angles, are placed in such order that the long limb of each lever may fall into the recesses when five slots (one in each disc) are in a direct line underneath it.

The selecting relays, acting through separate electro-magnets contained inside the printer case, control the horizontal movements of the discs, and by the combination of positive and negative currents, a selection is set up which results in one of the levers being free to enter the slots. This causes a stop to project in the path of the type-wheel carrier. The typewheel spindle is then released, and revolves until it reaches the stop. This brings the selected character into position for printing, and the paper is forced into contact with the type-wheel by a blow from a rubber-tipped bar.

Immediately the letter has been printed, the lever is released from the discs, and the paper moves forward to receive the next signal.

A continuous roll of paper, 82 in. in width, is fitted behind the printer, and as each message is completed it is cut off by the receiving operator drawing the paper against a fixed cutting edge.

To give the receiving operator full control over the printer, two press buttons are fitted at the side of the instrument. One of these marked "L.F." feeds up the paper, one step for each, depression; the other marked "C.R." works the carriage return mechanism.

The selecting relays are contained in a box, which stands in front of the printer, the top of the box being of suitable height for use as a writing desk. The separation of the relaybox from the printer permits of the two parts being independently changed.

To avoid the necessity of punching requests for messages to be re-run or re-perforated, a bell is fitted at one side of the relay-box, and by sending special signals, or by using the side lever of the latest form of Auto-Control Switch, the bell is rung from one to five times, the number of strokes indicating what is required, as shown below :

- 1 ring. Re-run last message.
- 2 rings. Re-run message now being transmitted.
- 3 " Re-punch last message.
- 4 " Re-punch message now being transmitted.
- 5 " Stop sending.

## DIVIDED CIRCUITS

A great advantage of all Multiplex systems is their flexibility in regard to the provision of Omnibus Circuits. Figures 16, 17, and 18 illustrate the interconnections possible between several centres.

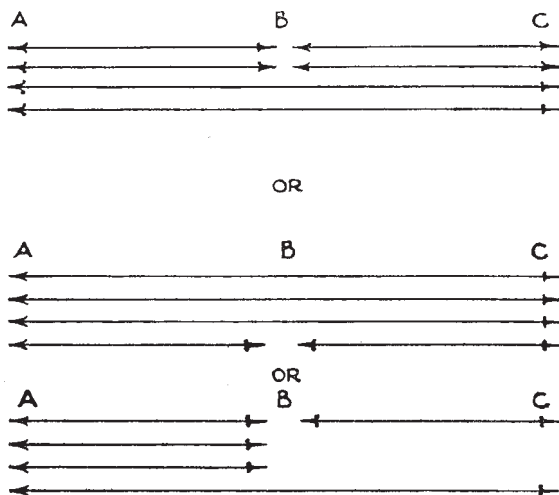

Fig 16.

In Fig. 16 for instance, 3 towns A, B and C are shown interconnected so as to give

4 channels, 2 in each direction, between A and B

4 channels, 2 in each direction, between A and C

4 channels, 2 in each direction, between B and C

Simple switching arrangements may be introduced at B so as to vary the disposition of the channels at will. Thus it would be possible to arrange for

8 channels, 4 in each direction, between A and C

*or*

6 channels, 3 in each direction, between A and C

2 channels, 1 in each direction, between A and B

2 channels, 1 in each direction, between B and C

or any other combinations desired.

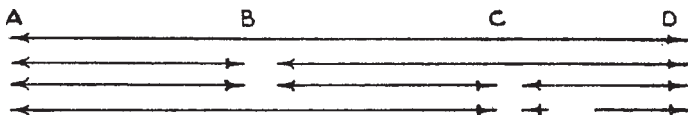

Fig 17.

Fig. 17 shows an extension of the system to serve 4 towns, giving:

4 channels, 2 in each direction, between A and B

4 channels, 2 in each direction, between C and D

2 channels, 1 in each direction, between A and C

2 channels, 1 in each direction, between B and C

2 channels, 1 in each direction, between C and D

or any similar combinations desired.

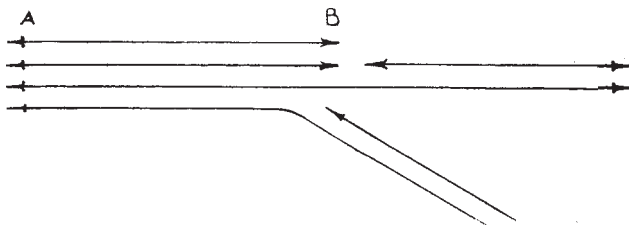

Fig 18.

Forked Circuits may also be readily made up. A typical instance, shown in Fig. 18, gives the following interconnections between 4 towns :

4 channels, 2 in each direction, between A and B

2 channels, 1 in each direction, between A and C

2 channels, 1 in each direction, between A and D

2 channels, 1 in each direction, between B and C

2 channels, 1 in each direction, between B and D

## TRAFFIC CAPABILITIES.

Theoretically, at a speed of 40 words per minute, each channel of the Western Electric (or any other Multiplex) should be capable of dealing with 80 average messages per hour, so that, with 4 channels, a total of 320 messages could be dealt with in 1 hour. With 4 channels duplexed so as to give 8 channels it should be possible to forward 320 and receive 320 messages in 1 hour.

In actual practice the *maximum* figures for the Western Electric Multiplex *for 1 hour* have been 300 messages forwarded and 263 received: a total of 563.

The highest total *for 1 day*, covering a period of 16 hours, has been 3,315 messages forwarded and 2,737 received, giving a total of 6,052 messages, i.e., an average of nearly 380 messages per hour. During a working day, of course, the 8 channels are not always worked, the number being varied to meet the flow of traffic during the early morning and late evening hours.

## THE MURRAY DUPLEX MULTIPLEX TYPE-PRINTING TELEGRAPH SYSTEM.

This system is based on the Duplex Baudot, and uses a Keyboard Perforator with cross perforated tape eleven-sixteenths of an inch wide and one-tenth of an inch per letter. The tape passes through an automatic transmitter having 5 pins controlled by the tape connected to 5 segments on a distributor. The received signals will eventually actuate page-printing mechanism but this portion has not yet been constructed.

One circuit is at present working with the old Murray perforator using Wheatstone perforating tape, and requiring half an inch feed per letter Baudot receivers have been altered to take the Murray re-arranged Baudot code, and they work well at 40 words per minute.

The transmitters are equipped with an Automatic starting and stopping device controlled by the tension of the paper tape. This will be an advantage for inexpert operators as they will be able to devote all their attention to the Keyboard.

## THE SIEMENS AND HALSKE AUTOMATIC TYPE-PRINTING TELEGRAPH SYSTEM.

This system is based on the Baudot code of 5 signals per letter using Alphabetical Keyboard Perforators to prepare a - perforated tape, in which the perforations are cross-wise, using about one-tenth of an inch per letter.

The width of the tape is about 1 1/5 inches, and there are two lines of feed holes, one on each side. The tape is torn off in suitable lengths of 3 or 5 messages according to traffic requirements, and is then passed through a transmitter having 5 pins which are controlled by the perforated tape. These pins operate five contact levers which are connected to five segments forming one ring of the transmitting distributor. The contact brushes of this distributor traverse the rings at 1,000 revolutions per minute giving a transmitting speed of 166 words per minute. The arriving signals pass through another distributor which passes the signals to one of two sets of local relays which are used alternately. As the Receiving Distributor brush arm rotates there is one particular position in its revolution where an electrical circuit is completed through the five tongues of these relays for each letter of the alphabet. In this position a condenser is discharged through a magnet which lifts a paper tape against a revolving type-wheel, thus printing the required letter. It is remarkable that the action of the magnet is so rapid that it is able to press the tape against the revolving type-wheel, and to obtain an unblurred impression although the wheel is revolving at 1,000 revolutions per minute.

The type-wheel has one row of letters and another of figures, etc., and is shifted along its axle by a particular signal, depending whether figures or, letters are required. Two sets of five relays are required, as one set is used for reception of the impulses of an incoming letter signal, while the other set already actuated is in use for completing the circuit of the printing magnet. Thus the printed letter is one revolution behind the incoming signals.

The distributors at the two ends have to be kept in correct phase relationship, and this is effected by the incoming signals controlling a speed correction motor which rotates as required in either direction to introduce, or to cut out, resistance in the circuit of the driving motor.

Incoming signals can be utilised to actuate a keyboard Perforator so as to produce a perforated tape as well as a printed tape, for messages that have to be repeated back or retransmitted on another circuit.

The received tape is gummed to a telegraph form in a similar way to the Hughes and Baudot tape. As the received signals actuate the printing mechanism without the necessity of preparing a perforated tape, the system is superior in this respect to either the Wheatstone Creed combination or the Murray automatic; but the system has the usual disadvantages of automatic systems as compared with Duplex Multiplex systems, and, although working at a speed of 160 words per minute in each direction, the hourly output is not quite so good as a quadruple Duplex Baudot at 120 words per minute.