

INSTALLATION MANUAL

ELECTRONIC MODULAR SWITCHING SYSTEM

KX-T30810

EASA-PHONE

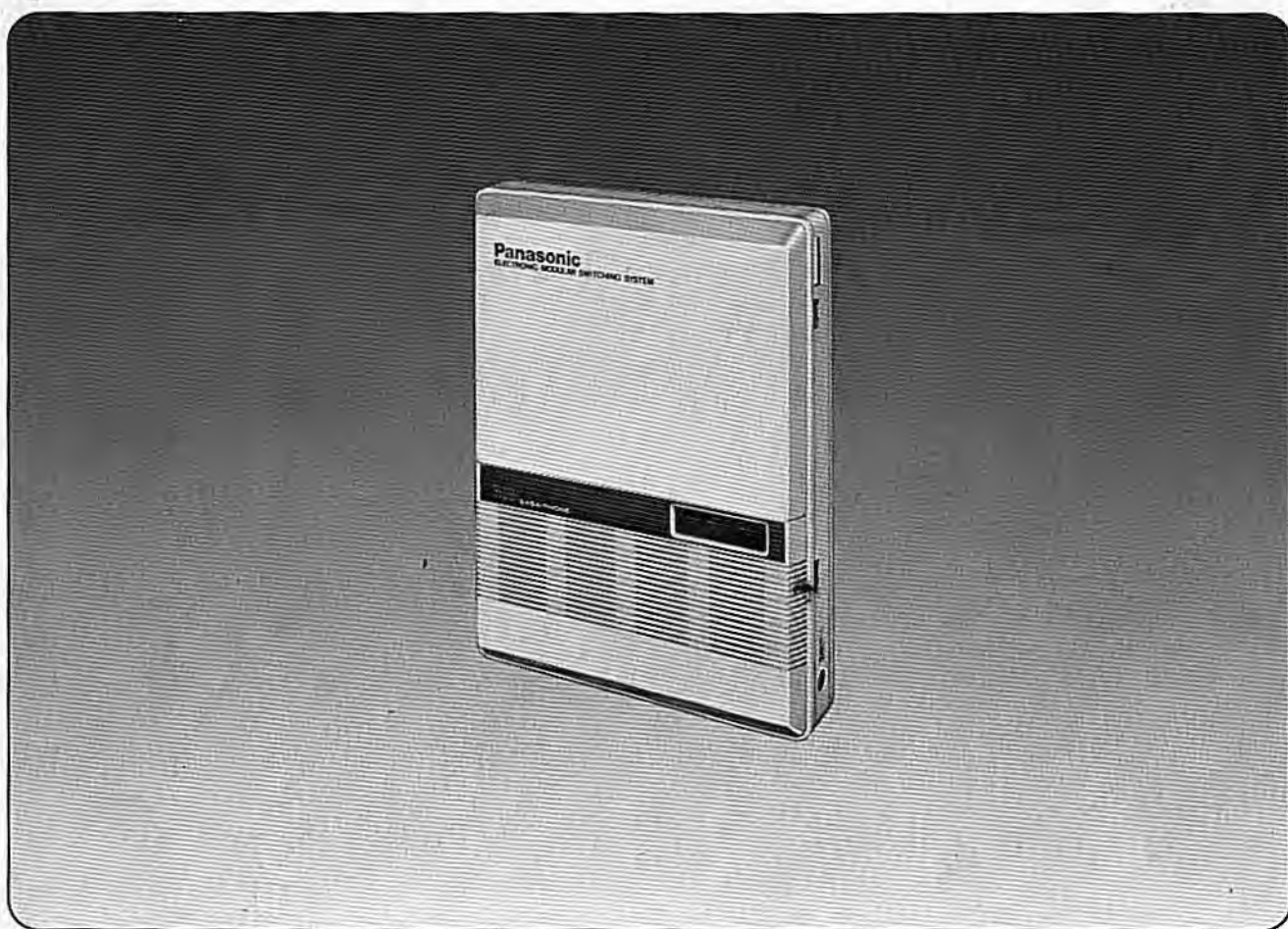

Panasonic

Please read this manual before connecting the KX-T30810.

Quick Reference Card for Standard Telephone can be found on pages 5-18 through 5-21.

*Thank you for purchasing the Panasonic Model KX-T30810,
Electronic Modular Switching System (EMSS).*

System Component

	<i>Model No.</i>	<i>Description</i>
<i>Service unit</i>	<i>KX-T30810</i>	<i>Electronic Modular Switching System</i>
<i>Telephone</i>	<i>KX-T30820</i> <i>KX-T30830</i> <i>KX-T30850</i>	<i>EMSS Proprietary Telephone</i> <i>EMSS Proprietary Telephone with LC</i> <i>Display</i> <i>EMSS Proprietary Telephone</i>
<i>Optional equipment</i>	<i>KX-T30860D</i> <i>KX-T30865</i> <i>KX-T30890</i> <i>KX-A16</i>	<i>Doorphone Adaptor</i> <i>Doorphone</i> <i>Headset</i> <i>System Back-up Unit</i>

NOTIFY THE TELEPHONE COMPANY

When you are required from the telephone company, notify the following:

- Telephone number to which the system will be connected
- Make Panasonic
- Model KX-T30800
- FCC Registration No. found on the bottom of the unit
- Ringer Equivalence 0.4B

- The Jack Code needed will depend upon the requirements of the telephone system to which the system will be connected.
The specific jack code needed can and should be ascertained by the telephone company at the time of installation.
- Present FCC Regulations prohibit connecting this unit to a party line, or to a coin operated telephone.

Please read the section on "Telephone Company and FCC Requirements and Responsibilities" on page 5-8.

The serial number of this product may be found on the label affixed to the bottom of the unit. You should note the serial number of this unit in the space provided and retain this book as a permanent record of your purchase to aid in identification in the event of theft.

MODEL NO.: KX-T30810 _____

SERIAL NO.: _____

For your future reference

DATE OF PURCHASE _____

NAME OF DEALER _____

DEALER'S ADDRESS _____

TABLE OF CONTENTS

Name and Location	1-1
Installation	1-2
Connection	1-4
Frame Ground Connection	1-5
Rechargeable Battery Installation	1-5
Connection of The Central Office Line	1-6
Connection of the Extension (for Proprietary Telephone KX-T30820/KX-T30830/KX-T30850).....	1-7
Connection of Standard Telephone to Extensions	1-8
External Music Source	1-9
Paging Equipment	1-9
Connection of The Optional Door phone (KX-T30865)	1-10
To Connect Polarity Sensitive Telephone	1-12
To Connect Optional System Back-up Unit (KX-A16)	1-13
Programming	
Programming Instructions	2-1
Example of Programming	2-3
	Default
Date and Time	86 JAN.01 WED 12:00 AM 2-4
System Speed Calling Entry	has not been stored 2-5
CO Connection Assignment	has been added 2-8
Dial Mode (Tone/Pulse) Selection	TONE 2-9
Switching Mode (Day/Night Service)	manual mode 2-10
Starting Time (Day/Night Service)	day service 9:AM night service 5:PM 2-11
Flexible Day Outward Dialing Assignment	all CO's have been assigned on all extensions 2-13
Flexible Night Outward Dialing Assignment	all CO's have been assigned on all extensions 2-14
Flexible Day Ringing Assignment	all CO's have been assigned on all extensions 2-15
Flexible Night Ringing Assignment	all CO's have been assigned on all extensions 2-16
Toll Restriction—Class Assignment	Class 1 2-17
Toll Restriction—Area Code Selection	has not been stored 2-19
Programmable Operator Call	has been added 2-20
Host PBX Access Codes Assignment	has not been stored 2-21

Automatic Answering (Automatic/Manual) Selection	Auto Answer	2-22
Preferred Line Assignment	non-assignment	2-23
Programmable Call Waiting	has been removed	2-24
Duration Time Count Start Mode	5S after dial	2-25
Hookswitch Flash Timing	600 msec	2-26
Disconnect Time	1.5 sec	2-27
Calling Party Control (CPC) Signal	has been added	2-28
Intercom Alerting Mode	Tone Call	2-29
Programmable Doorphone	D-Phone 1, 2	2-30
Dial Call Pickup Group Assignment	Pickup-G:1	2-31
Busy Tone Selection	TONE: 1	2-32
Hold Time Reminder	3 minutes	2-33
Hold Recall Time Set	30 sec	2-34
Programmable External Paging Access Tone	has been added	2-35
Programmable Toll Prefix	with 1	2-36
Programmable Secret Auto Dial	No Secret	2-37

Detailed Feature Description and Operation for EMSS Proprietary Telephone

To Make Calls

Inter Office Calling (Intercom)	3-1
Outward Dialing	3-2
Speed Dialing	3-3
One Touch Dialing	3-4
Calling Doorphone	3-6
Distinctive Dial Tone	3-6

When a Line is Busy

Automatic Call Back Busy—(Camp-on)	3-7
Busy Station Signaling	3-8
Last Number Redial	3-8

To Receive Calls

Answer	3-9
Automatic Answer-Intercom	3-9
Dial Call Pickup	3-10
Directed Call Pickup	3-10
Call Park Retrieve	3-11
Doorphone	3-12
Distinctive Ring Tone	3-12

While Having a Conversation

Call on Hold-CO	3-13
Call on Exclusive Hold-CO	3-14
Call on Hold-Intercom	3-15
Call on Exclusive Hold-Intercom	3-16
Conference	3-17
Call Waiting	3-18
Call Transfer	3-19
Call Splitting-Between CO and Intercom	3-20
Call Splitting-Intercom	3-21

Paging	
Paging All Extensions	3-21
Paging Group	3-22
Paging—External	3-22
Paging And Transfer	3-23
Paging-Answer	3-23

Use of Other Features	
Background Music	3-24
Mute Operation	3-25
One Touch Access for System Features	3-25
External Feature Access	3-26
Pulse/Tone Conversion	3-27
Time Setting	3-27
Intercom Alerting Mode	3-28
Busy Lamp Field	3-28
Duration Time of Call Display	3-29
Lockout	3-29
Mixed Station Dialing	3-29
Power Failure Transfer	3-29

Station Programming	
Call Forwarding	3-30
Dial Call Pickup Deny	3-32
Do not Disturb	3-33
Data Line Security	3-34
Saved Number Redial	3-34
Flexible Night Service	3-35
Station Program Clear	3-36

Operation for Standard Telephone	
To Make Calls	4-1
When a Line is Busy	4-2
To Receive Calls	4-3
While Having a Conversation	4-4
Paging	4-5
Use of Other Features	4-6
Station Programming	4-8

Troubleshooting	
During Installation	5-1
During Connection	5-2
During Operation	5-3
Reset Button	5-3
DTMF Receiver Check	5-4

Table of System Features	5-5
---------------------------------	-----

List of Tones	5-6
----------------------	-----

List of Ring Tones	5-6
---------------------------	-----

Specification	5-7
----------------------	-----

Telephone Company and FCC Requirements and Responsibilities	5-8
--	-----

Others	5-9
---------------	-----

Warranty	5-10
-----------------	------

Servicenter List	5-11
-------------------------	------

Phone Number Directory	5-12
-------------------------------	------

Programming Table	5-14
--------------------------	------

Quick Reference Card for Standard Telephone	5-18
--	------

NAME AND LOCATION

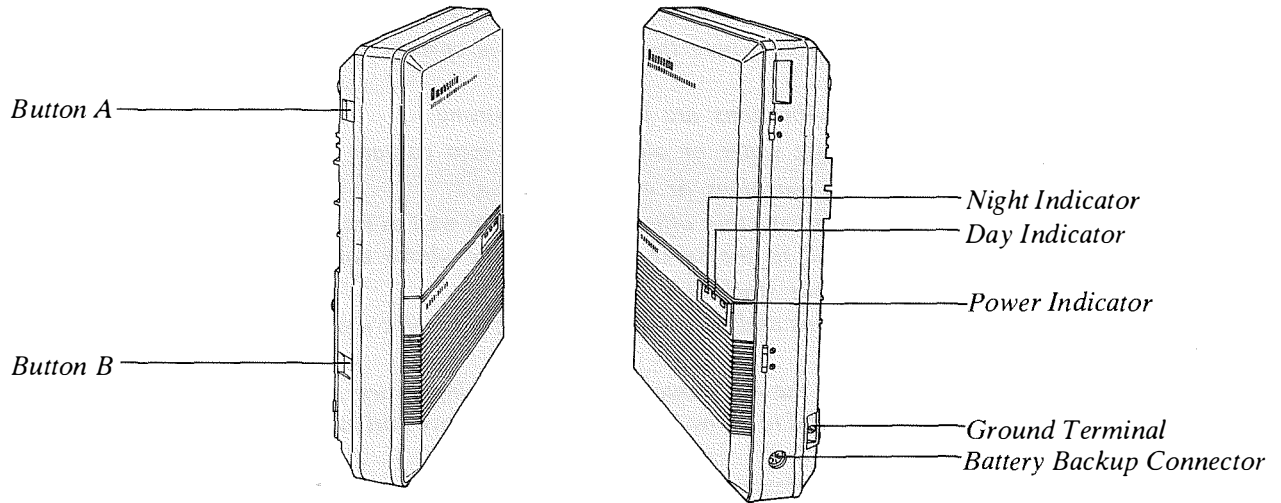

Push Buttons A and B simultaneously to open Front Cover.

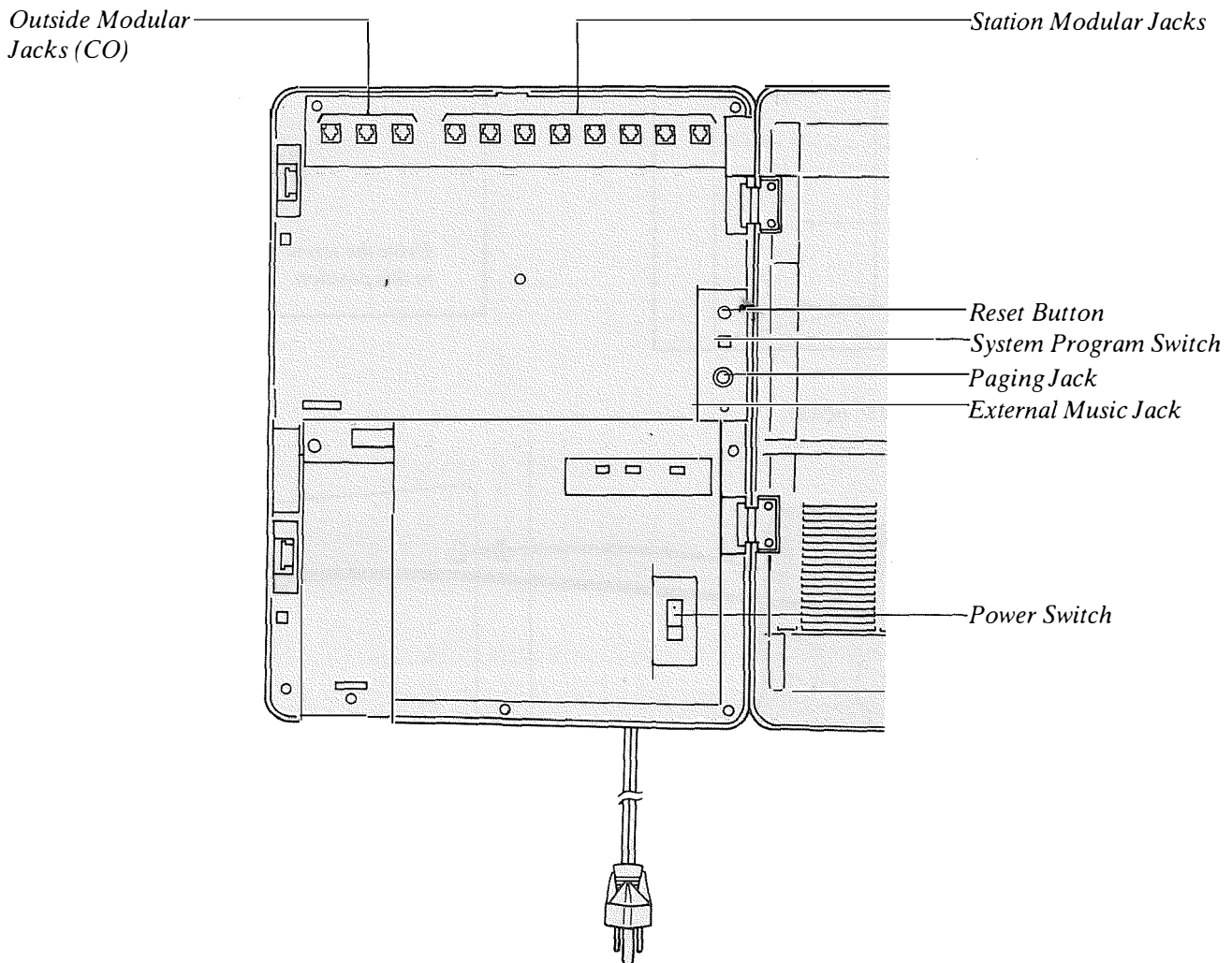

INSTALLATION

Cautions

● Avoid installing in the following places. (Doing so may result in malfunction, noise, or discoloration.)

1. In direct sunlight and hot, cold, or humid places. (Temperature range: 32°F–104°F)
2. Sulfuric gases produced in areas where there are thermal springs, etc. may damage the equipment or contacts.
3. Places in which shocks or vibrations are frequent or strong.
4. Dusty places, or places where water or oil may come into contact with the unit.
5. Near high-frequency sewing machines or electric welders.
6. On or near computers, telexes, or other office equipment, as well as microwave ovens or air conditioners. (It is preferable not to install in the same room with the above equipment.)
7. Near radio broadcast antennas (including short wave).
8. Install at least 6 feet from radios and televisions. (both the electronic modular switching system and EMSS proprietary telephones)
9. Do not obstruct area around the electronic modular switching system. (for reasons of maintenance and inspection—be especially careful to allow space for cooling above and at the sides of the electronic modular switching system)

The wall where the KX-T30810 is to be mounted must be able to support a weight of KX-T30810. If screws other than the ones supplied are used, use the same-sized diameter screws at the enclosed ones.

To Mount on the Wooden Wall:

1. Place the templet (included) on the wall to mark the 3 screw positions.

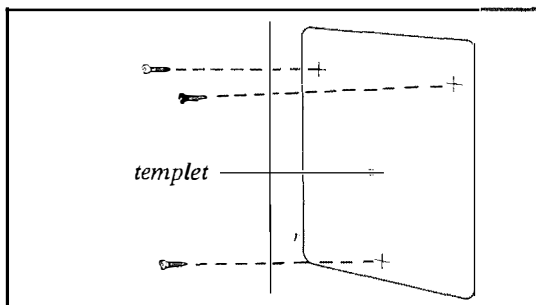

2. Install the 3 screws into the wall.

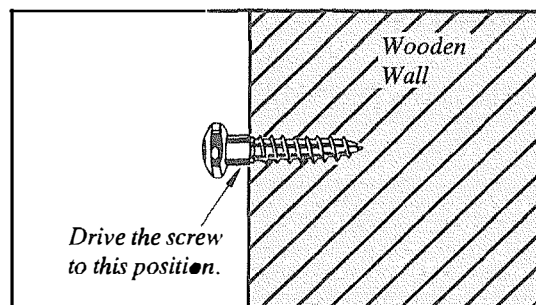

3. Hook the unit on the screw heads.

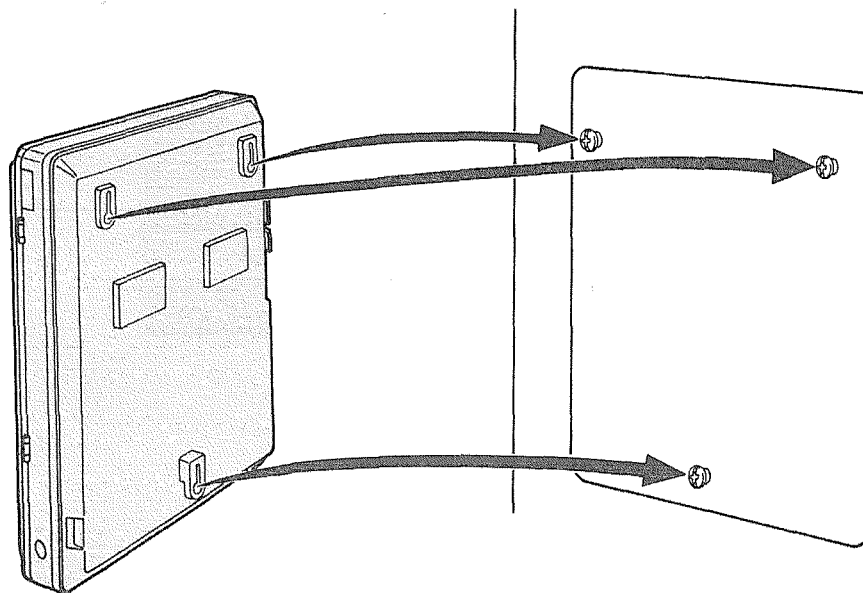

To Mount on Concrete or Mortar Wall:

1. Place the templet (included) to mark the 3 screw positions.

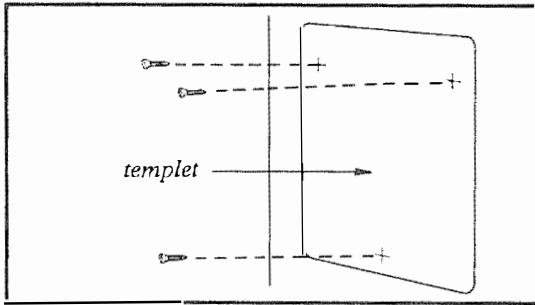

3. Install the 3 screws into the anchor plugs.

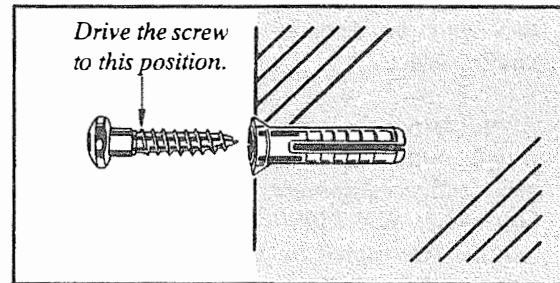

2. Drill 3 holes and drive the anchor plugs (included) with a hammer, flush to the wall.

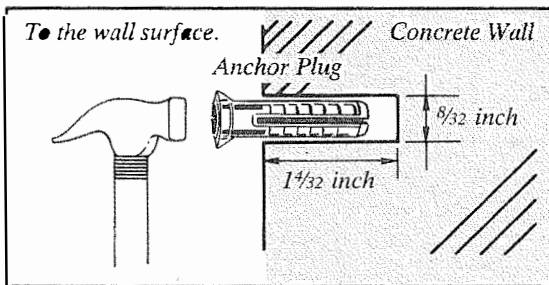

4. Hook the unit on the screw heads.

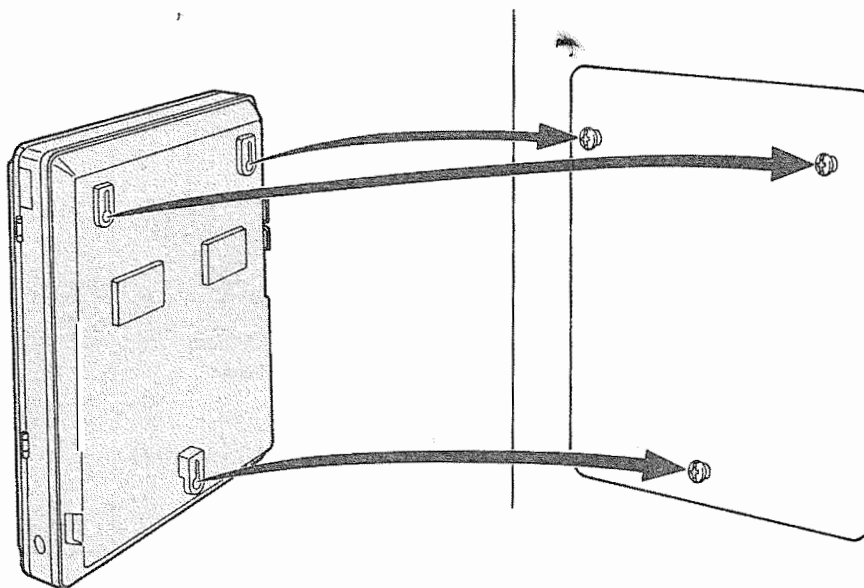

CONNECTION

Cautions

1. Do not wire the telephone cable in parallel with the AC power source, computer, telex, etc. If the cables run near those wires, shield the cables with metal tube or use shield cables and ground the shields.
2. When cables run on the floor, use protectors or the like to protect the wires where they may be stepped on. Avoid wiring under carpets.
3. Avoid using the same AC 120 V power supply outlet for computers, telexes, and other office equipment. Otherwise, KX-T30810 system operation may be interrupted by the induction noise from such equipments.
4. Please use one pair telephone wire for extension connection of (telephone) equipments such as standard telephone, data terminal, answering machine, computer, etc., except proprietary telephone KX-T30830, KX-T30820, KX-T30850 etc.).

After all the connections are completed, turn the Power Switch ON.

If an extension does not operate properly (for example: The LCD of the KX-T30830 does not display properly.), disconnect the telephone from the extension line and then connect again, or turn OFF the power switch of the KX-T30810 and then ON again after 5 minutes.

Optional System Back-up Unit (KX-A16)

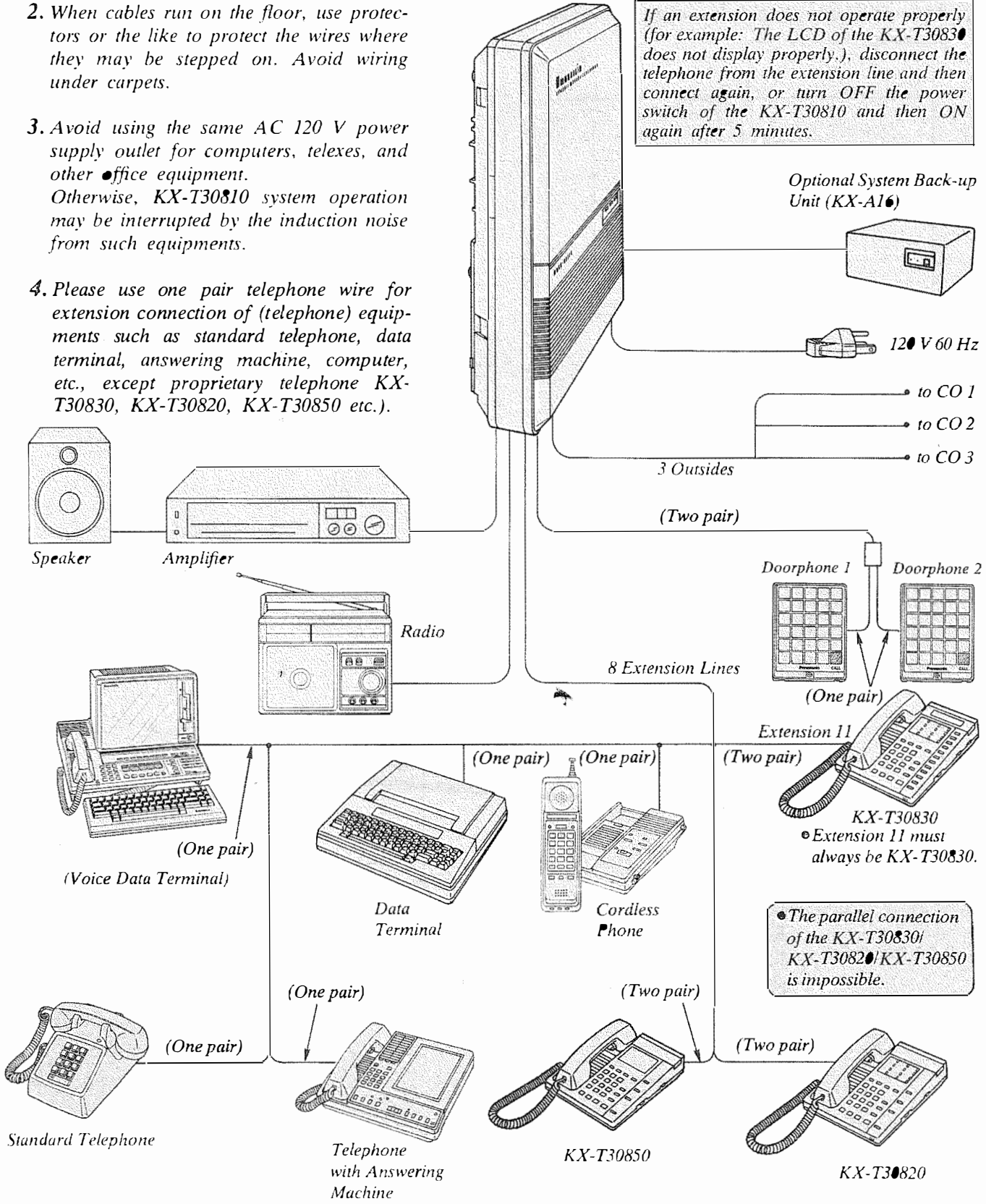

• The parallel connection of the KX-T30830/ KX-T30820/ KX-T30850 is impossible.

• Extension 11 must always be KX-T30830.

Frame Ground Connection

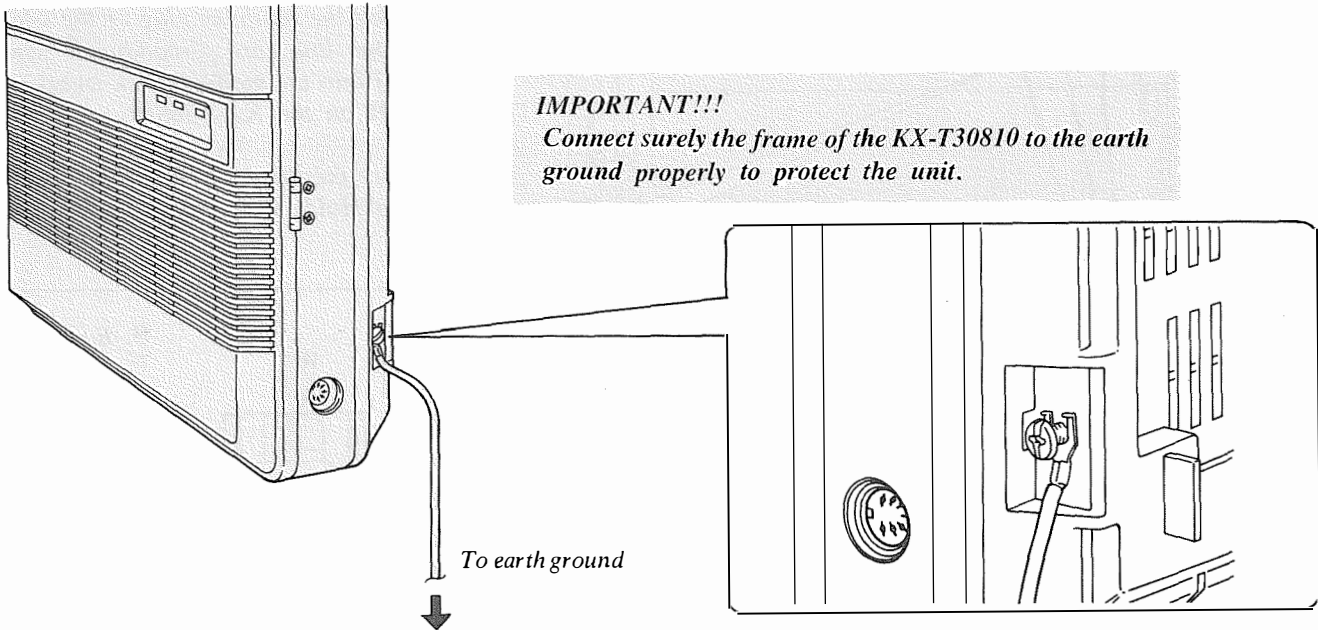

Rechargeable Battery Installation

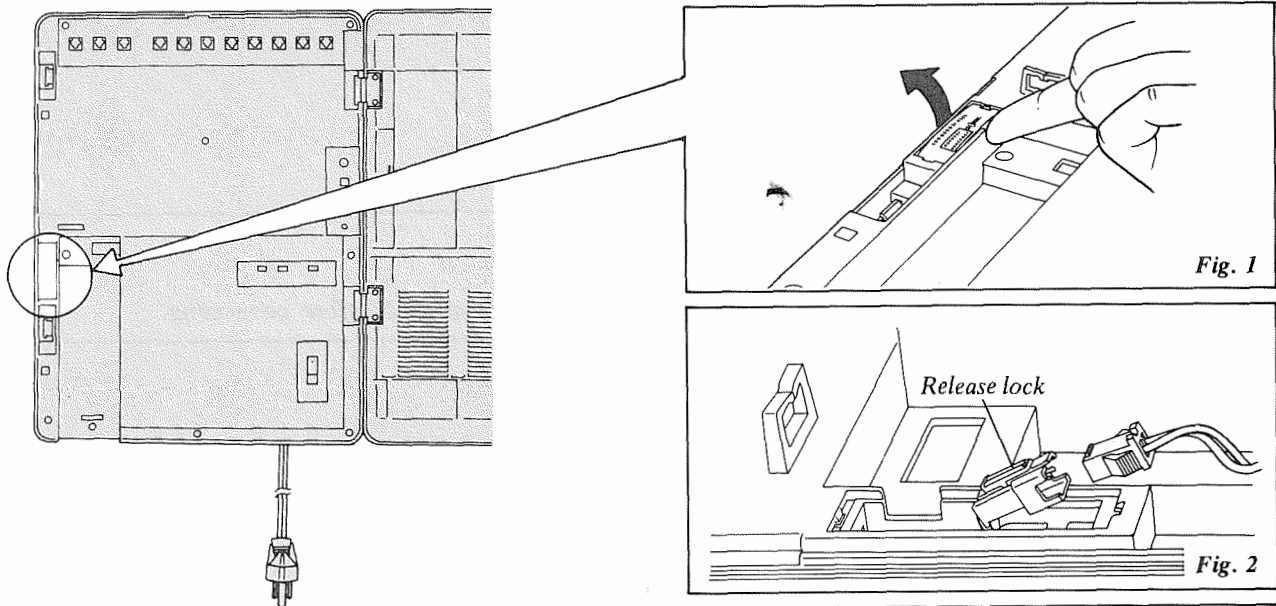

1. Remove the battery cover from the compartment. (Fig. 1)
2. Connect the battery (included). (Fig. 2)
3. Install the battery into the battery compartment. (Fig. 3)

*Replace the battery every 5 years with (P-01H-F2G1). To remove connector, depress to release and slide (pull) apart connector. (Fig. 2)

Connection of The Central Office Line

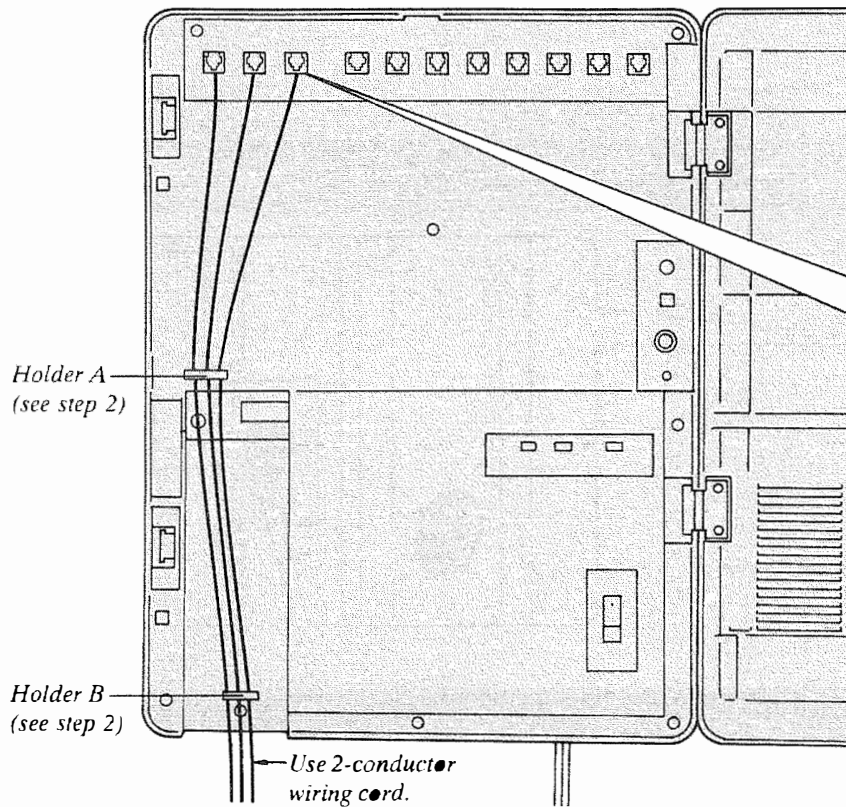

1. Insert the modular plug of the telephone line cord (2-conductor wiring) into the modular jack (marked CO) on the KX-T30810.

2. Place the three telephone line cords into Holders A and B.

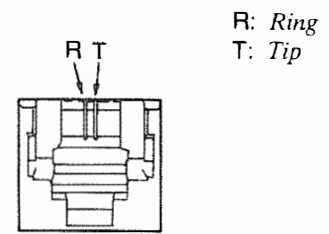

View of TEL Jack (CO)

To Terminal Board or Modular Jacks
from the Central Office (CO).

Caution

Mis-connection may cause the KX-T30810 to operate improperly.

See "During Installation" page 5-1 and "During Connection" page 5-2 before connecting.

Connection of The Extension (for Proprietary Telephone KX-T30820/KX-T30830/KX-T30850)

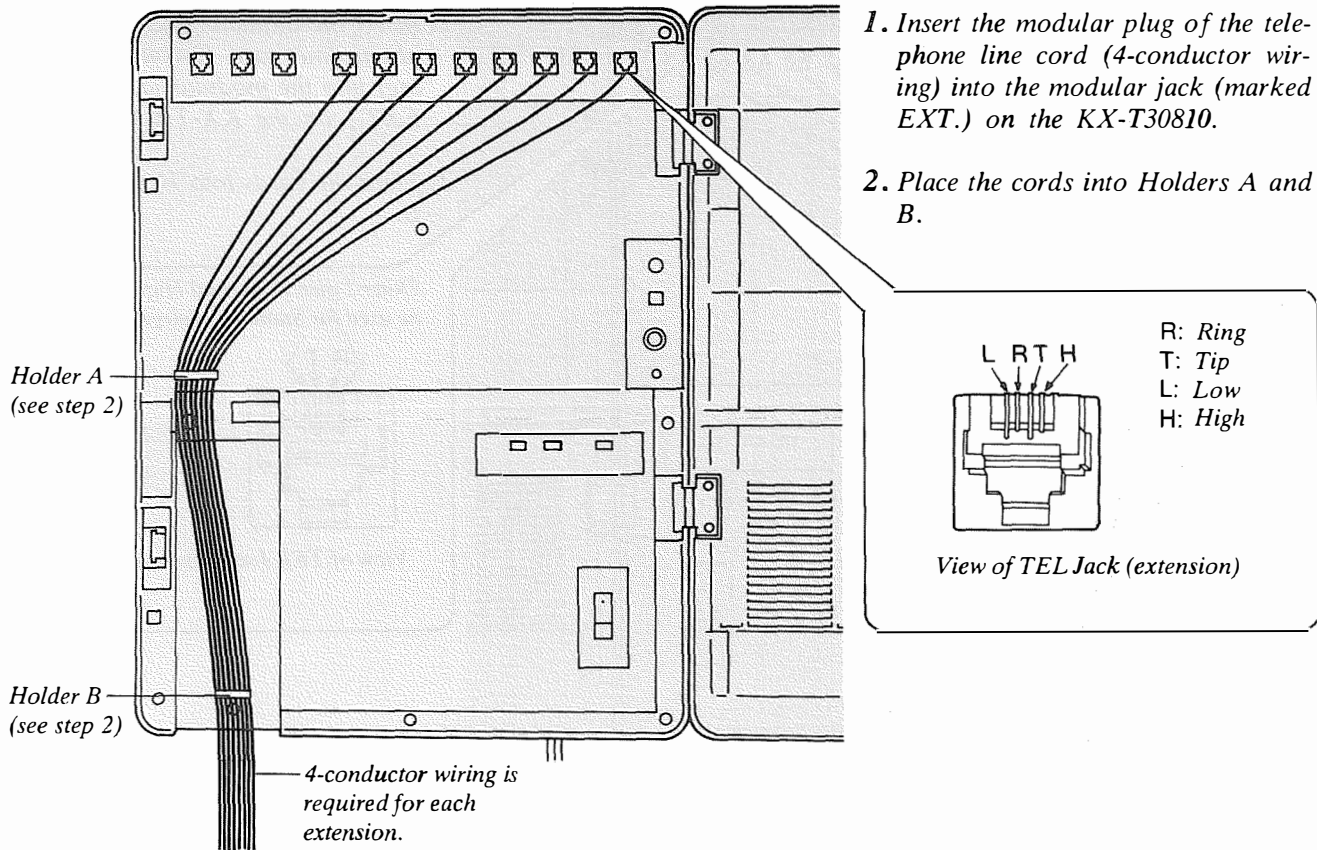

To Extensions

- The inner 2 wires (red, green) are for Tip and Ring and the outer 2 wires (black and yellow) are for Low and High (DATA).
- The max. length of the telephone line cord that connects the KX-T30810 and the extension is shown below.
 - 26 AWG: Under 460 feet
 - 24 AWG: Under 750 feet
 - 22 AWG: Under 1180 feet

Caution

Mis-connection may cause the KX-T30810 to operate improperly. See "During Installation" page 5-1 and "During Connection" page 5-2 before connecting.

Connection of Standard Telephone to Extensions

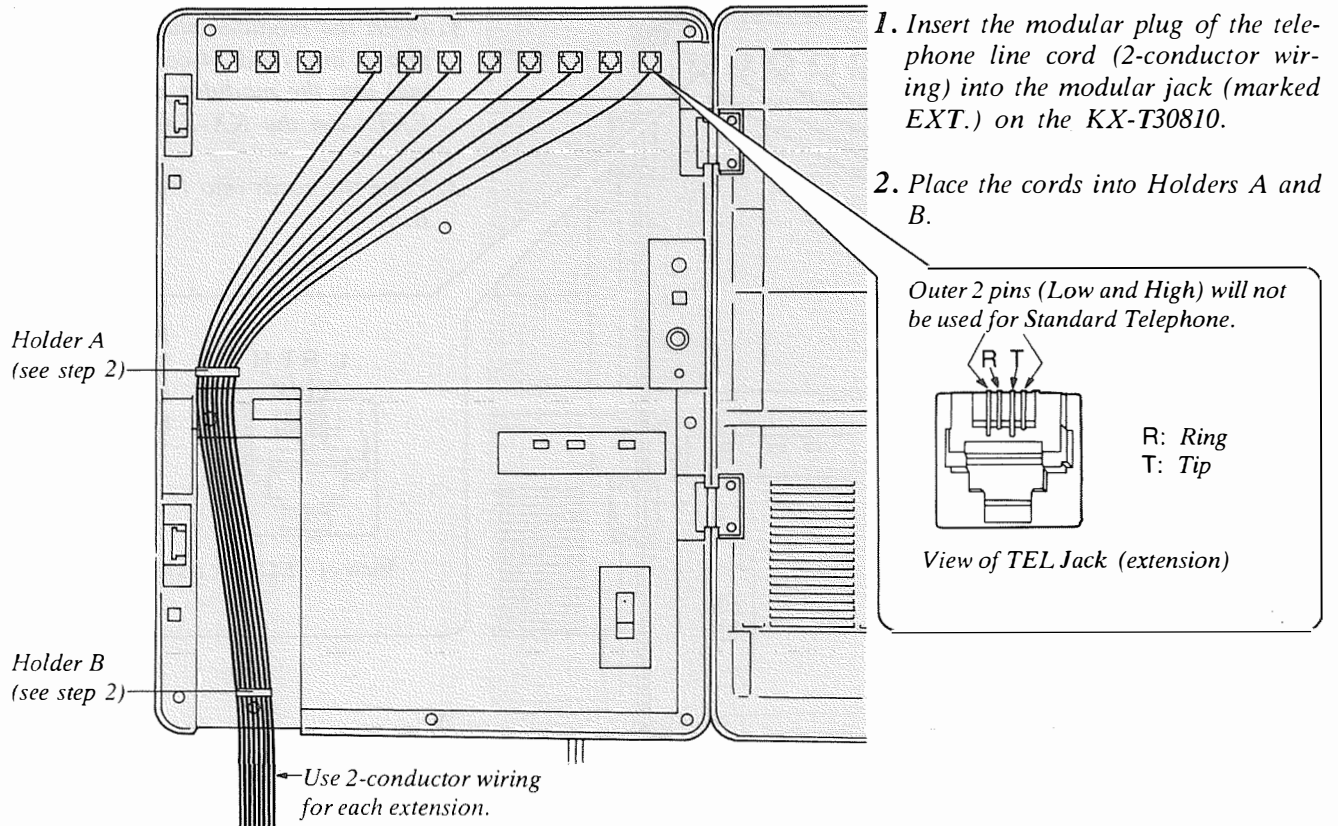

To Extensions

- The max. length of the telephone line cord that connects the KX-T30810 and the extension is shown below.
 - 26 AWG: Under 2290 feet
 - 24 AWG: Under 3700 feet
 - 22 AWG: Under 5900 feet
- If the telephone or answering machine with A-A1 relay is connected to the KX-T30810, set the A-A1 relay switch of the telephone or answering machine to OFF.

Caution

Mis-connection may cause the KX-T30810 to operate improperly.
See "During Installation" page 5-1 and "During Connection" page 5-2 before connecting.

External Music Source

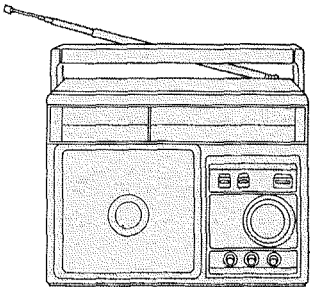

External Music Source

Adjust the sound level of the music on hold with the Volume control.

- Use a two-conductors plug (3/4 inch in diameter)
- Input impedance 5 k Ω
 - Input Level -10 dBm

Use a cord that has the internal resistance 10 Ω .

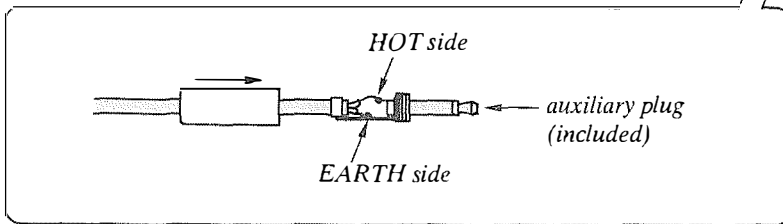
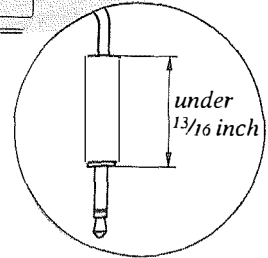
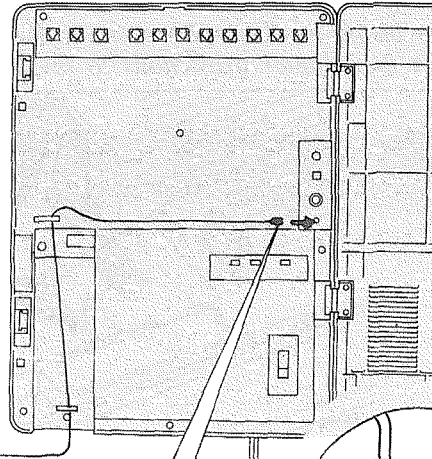

CONNECTION

Paging Equipment

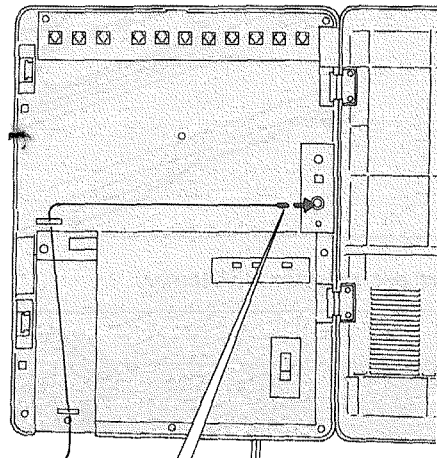
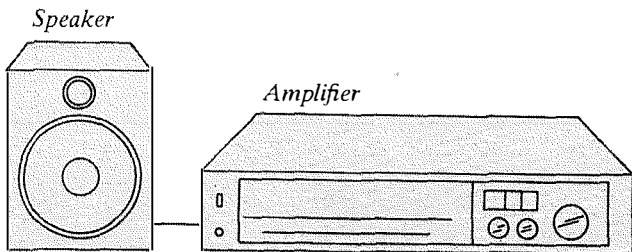

Use shielded cable.

Use RCA connector.

- Output impedance: 600 Ω

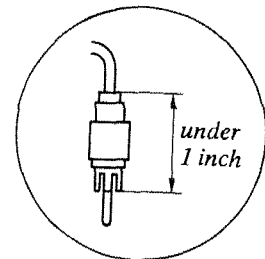
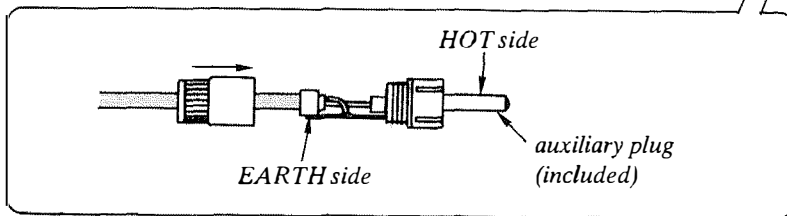

Connection of The Optional Doorphone (KX-T30865)

For installing the doorphone, use the Optional Doorphone Adaptor (KX-T30860D).

I. How to install the Doorphone to the KX-T30810

- ① Insert the adaptor projections to the holes.

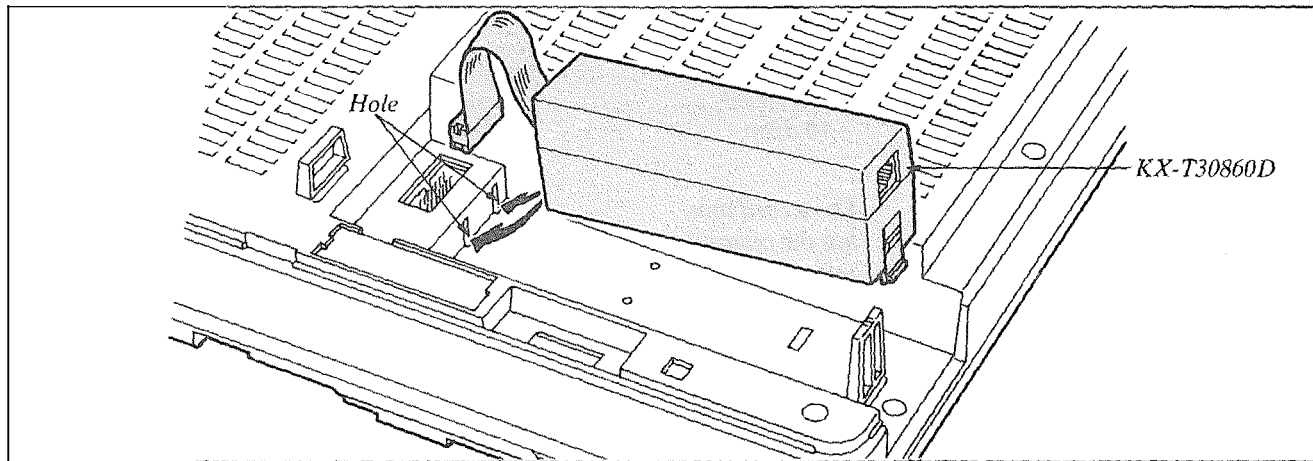

- ② Push the adaptor down so that it locks into the ribs of the unit.

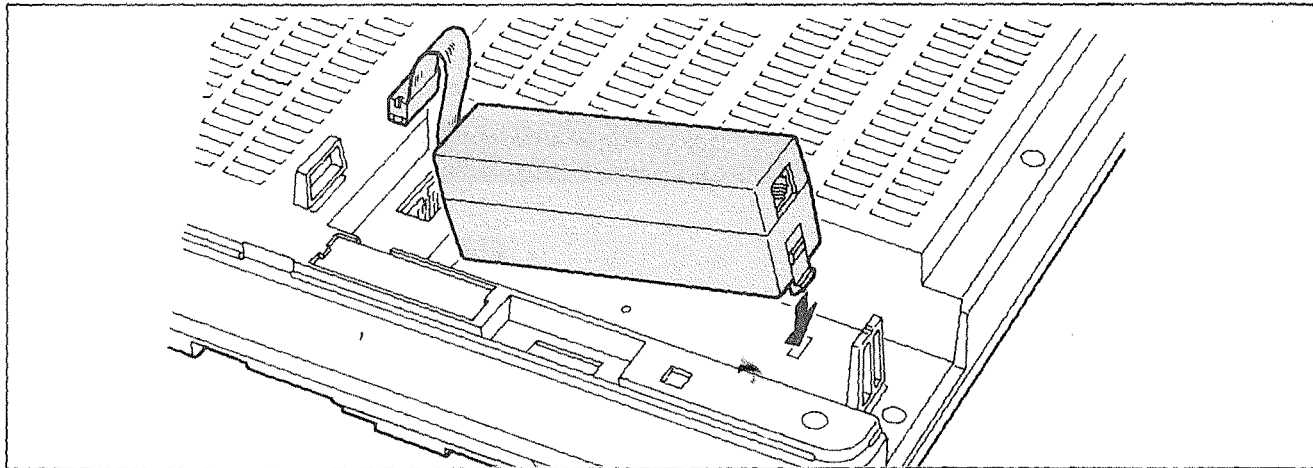

- ③ Insert the adaptor connector.

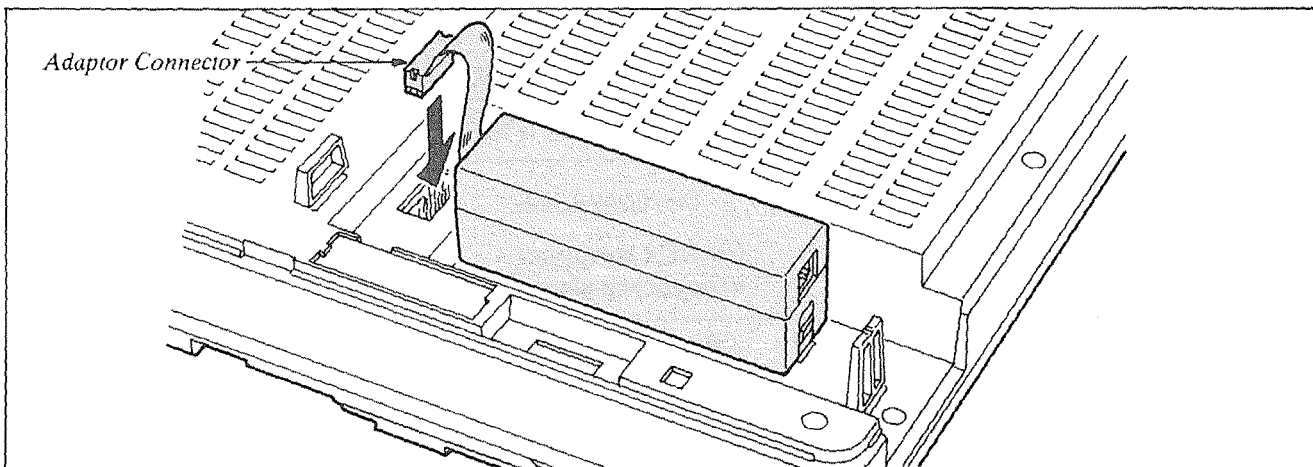

2. Wiring connection of the Doorphone

- (A) Connect the doorphone to the terminal box using 4-conductor modular connectors.
- (B) Connect the wires of doorphone 1 to the red and green screws of the terminal box.
- (C) Connect the wires of doorphone 2 to the yellow and black screws of the terminal box.

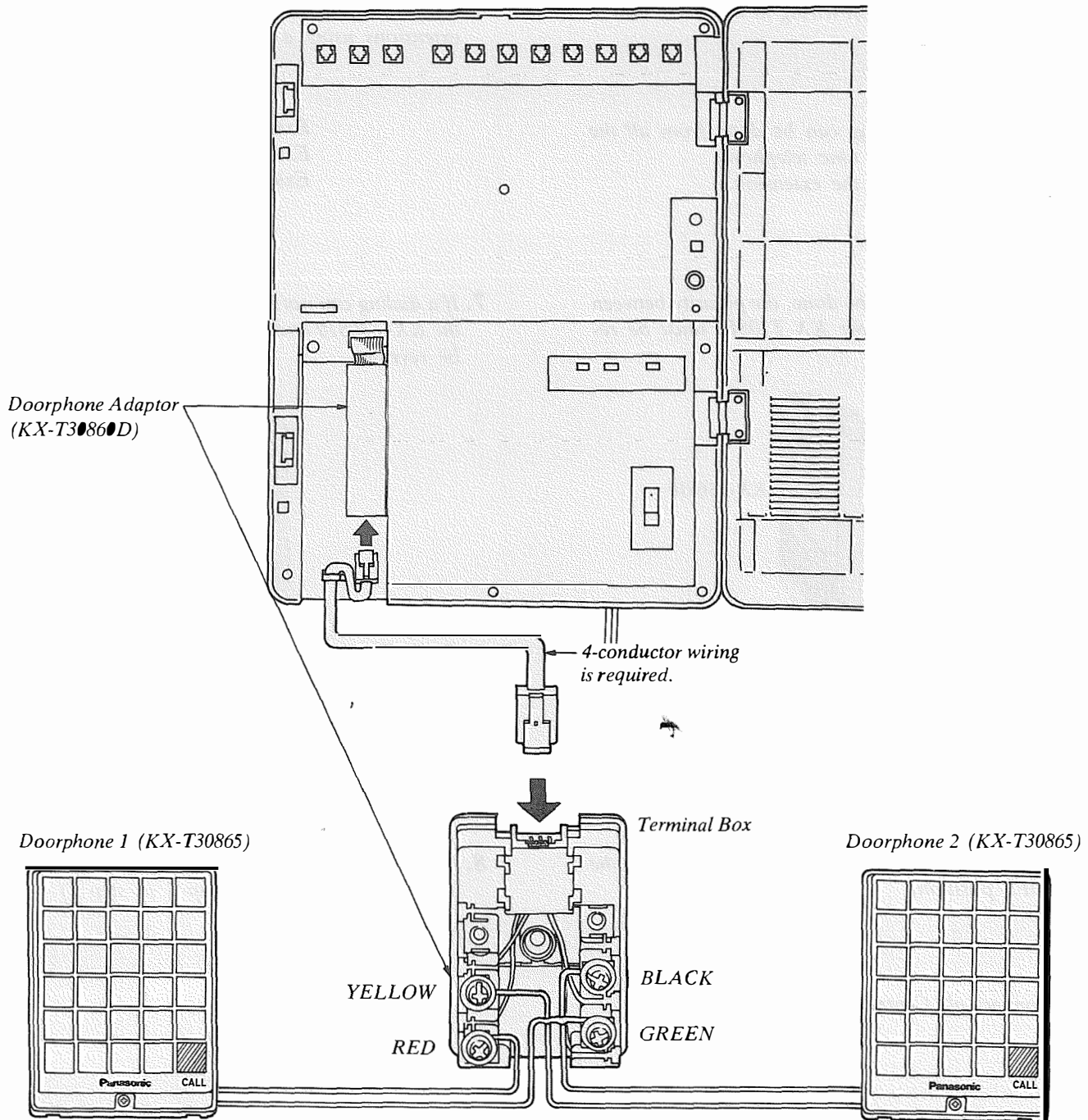

• The max. length of the telephone line cord that connects the KX-T30810 and the doorphone (KX-T30865) is shown below.

- 26 AWG: Under 230 feet
- 24 AWG: Under 370 feet
- 22 AWG: Under 590 feet

To Connect Polarity Sensitive Telephone

If the telephone you are using with the KX-T30810 is polarity sensitive.

1. Connect all extension wiring to the KX-T30810.

6. Confirm that dialing can be done on following extensions using a tone telephone.

2. Confirm that dialing can be done from all the extensions using a tone telephone.
(Do not exchange the extension.)

Extension 11...CO 1
Extension 12...CO 2
Extension 13...CO 3

3. If a dialing can not be done, the polarity between the extension and the KX-T30810 must be reversed.

7. If a dialing can not be done, the polarity between the KX-T30810 and the Central Office Line must be reversed.

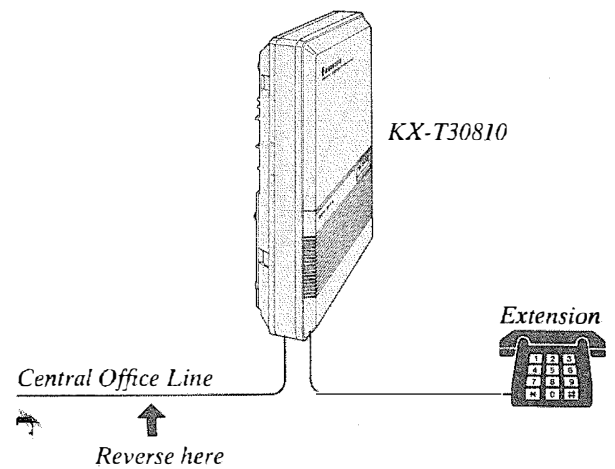
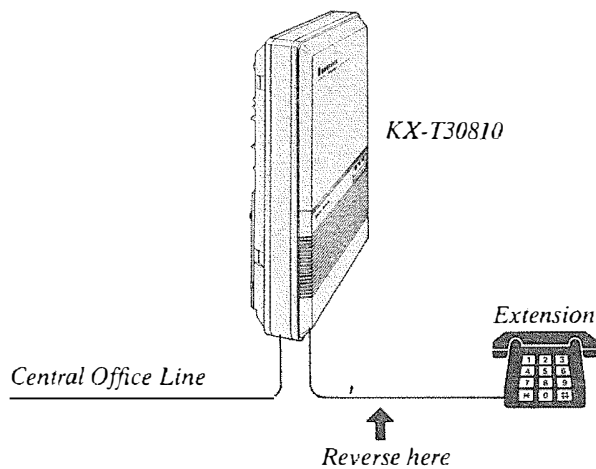

4. Set the Power Switch on the KX-T30810 to the OFF position.

8. If any extension is changed or replaced, repeat these procedures (from step 1 to step 7).

5. Connect all Central Office (CO) Lines.

To Connect Optional System Back-up Unit (KX-A16)

1. Connect the cord from the optional KX-A16 to the KX-T30810.
2. Plug in the AC power cord from the KX-A16.
3. Turn on the Power Switch located on the KX-A16.
 - ⦿ Approximately 24 hours is required to recharge the KX-A16.
 - ⦿ The KX-A16 will work for approximately 4 hours (on the average) in the event of power failure.

- ⦿ The Battery life is 3 years.
- ⦿ A simple way to check the KX-A16 is to disconnect the KX-T30810 and the KX-A16 from the AC outlets, and then to observe if the KX-T30810 operates.
- ⦿ If the KX-T30810 does not operate, recharge the KX-A16.
- ⦿ AC Primary Fuse, (250 V, 1.25 A)×1:
Replace the fuse which is in the fuse holder located on the rear, if the CHARGE Indicator is off.

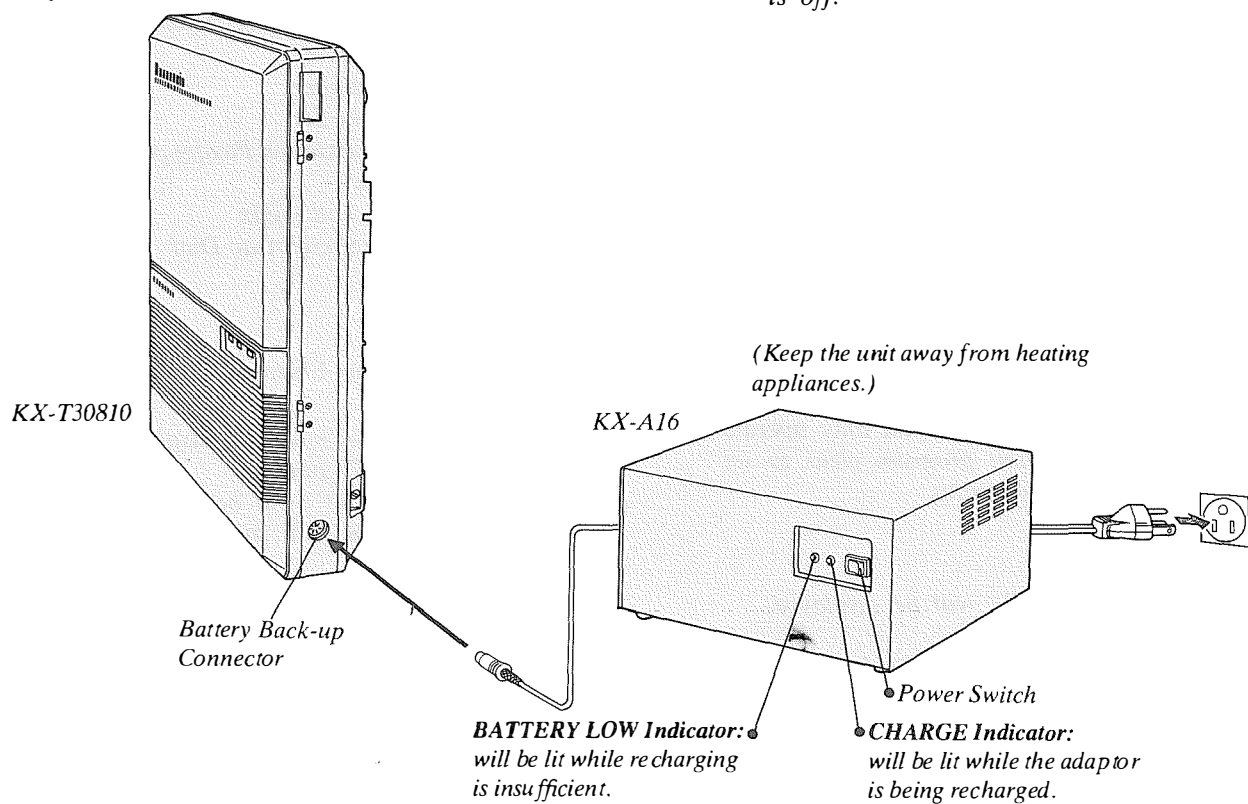

PROGRAMMING

To activate this system, the requirements from telephone company and the customer must be programmed once the Power Switch has been turned on.

Programming Instructions

1. At extension 11:

All system programming changes (example: system clear, station program clear, toll restriction, hookswitch flash timing...) are done through extension 11.

☉ **Extension 11 must always be a Panasonic model, KX-T30830.**

2. System Program Switch setting:

The System Program Switch located on the KX-T30810 must be set to the PROGRAM position while making program changes. After all programming changes are completed, return the program switch to the SET position.

3. Overlay:

This overlay is used for programming the system and the program function names on buttons are inscribed on this card. Refer to page 2-2.

4. Before system programming, you may operate system clear and station program clear to set default data of programming.

A. System Clear:

1 Dial (99).

☉ "SYSTEM CLEAR" will be displayed.

2 Press the NEXT button.

☉ "ALL CLEAR?" will be displayed.

3 Press the MEMORY button to clear system.

4 To exit from system clear, press the END button.

The following features are preset as the default data.

Date and Time

System Speed Calling

CO Connection Assignment

Dial Mode (Tone/Pulse) Selection

Switching Mode (Day/Night Service)

Starting Time (Day/Night Service)

Flexible Day Outward Dialing Assignment

Flexible Night Outward Dialing Assignment

Flexible Day Ringing Assignment

Flexible Night Ringing Assignment

Toll Restriction—Class Assignment

Toll Restriction—Area Code Selection

Programmable Operator Call

Host PBX Access Codes Assignment

Automatic Answering (Automatic/Manual) Selection

Preferred Line Assignment

Programmable Call Waiting

Duration Time Count Start Mode

Hookswitch Flash Timing

Disconnect Time

Calling Party Control (CPC) Signal

Intercom Alerting Mode

Programmable Doorphone

Dial Call Pickup Group Assignment

Busy Tone Selection

Hold Time Reminder

Hold Recall Time Set

Programmable External Paging Access Tone

DTMF Receiver

Programmable Toll Prefix

Programmable Secret Auto Dial

B. Station Program Clear:

1 Dial (98).

☉ "EXT CLEAR" will be displayed.

2 Press the NEXT button.

☉ "ALL CLEAR?" will be displayed.

3 Press the MEMORY button to clear the system.

4 To exit from station clear, press the END button.

The following features are preset as the default data.

One Touch Dialing

Background Music

Call Forwarding

Data Line Security

Dial Call Pickup Deny

Do not Disturb

When the System Program Switch on the KX-T30810 is set to the PROGRAM position, the operation of the KX-T30830 will change as follows.

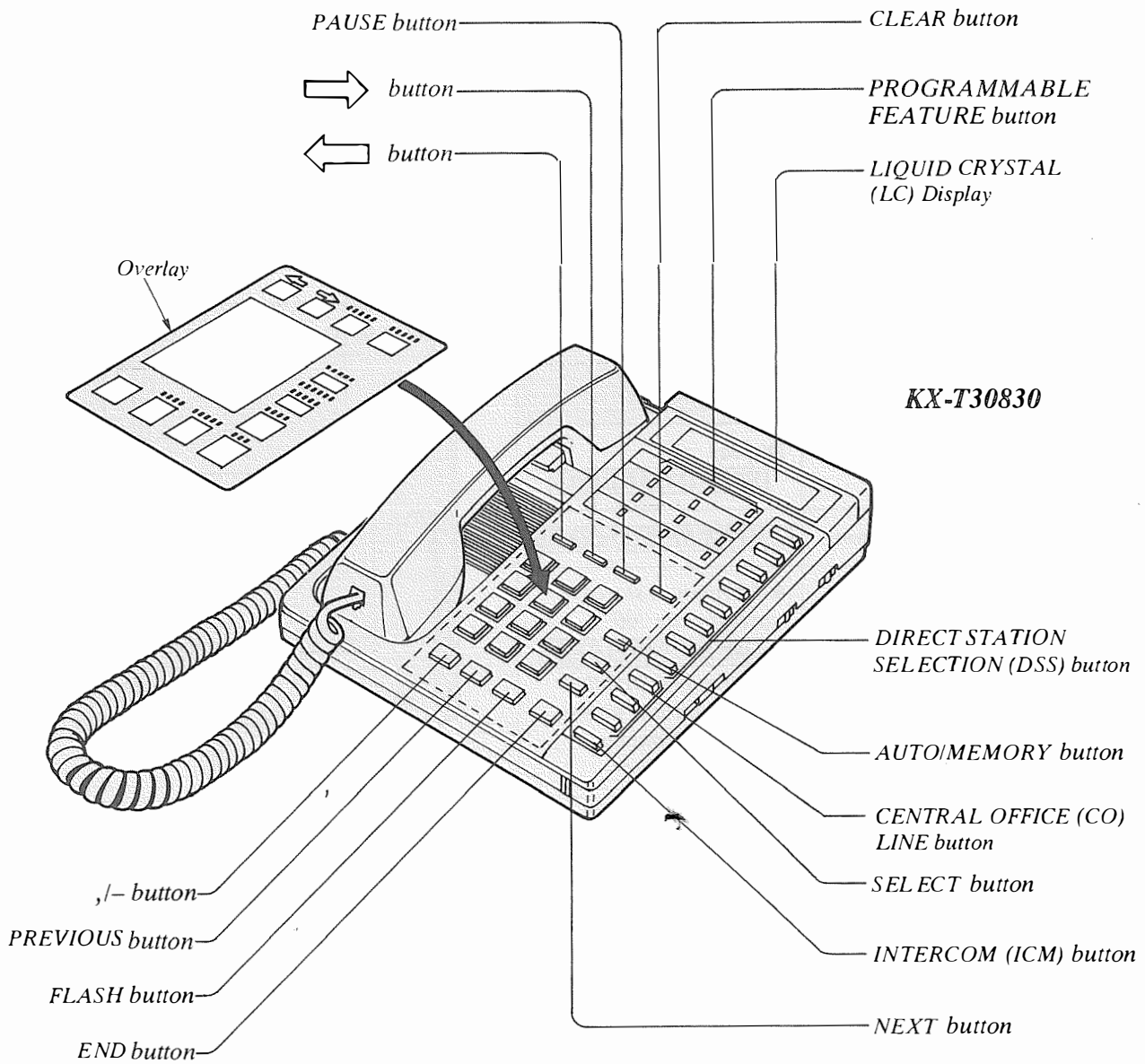

PROGRAMMING

Example of Programming

1. Turn the Power Switch to ON

2. Set the System Program Switch to PROGRAM

The LCD on the KX-T30830 shows "ENTER PGM CODE".

• Be sure the handset of the extension 11 is in the cradle and the speakerphone button of the extension 11 is off.

3. To program automatic line access number 9 and the phone number 987-654-3210 into memory location (speed dial access) number 00. (Refer to page 2-5.)

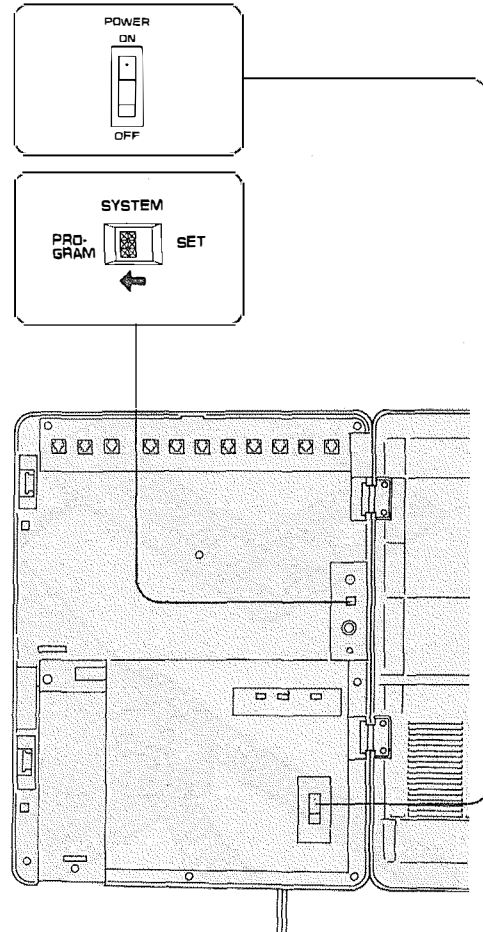

KX-T30830 at extension 11 (Extension 11 must always be KX-T30830.)		
1.	Dial (01) or press the AUTO button.	Display SPEED CALLING
2.	Press the NEXT button.	ENTER SPEED CODE
3.	Dial (00) or press the NEXT button.	<ul style="list-style-type: none"> • If nothing is stored in access code "00", 00: NOT STORED • If already stored the automatic line access number 9 and the phone number 123-456-7890, 00: -123-456-7890
4.	<ul style="list-style-type: none"> ① Dial "9". ② Press "-" button. ③ Dial "987". ④ Press "-" button. ⑤ Dial "654". ⑥ Press "-" button. ⑦ Dial "3210". 	00: -987-654-3210
5.	Press the MEMORY button.	●0: -987-654-3210
6.	<ul style="list-style-type: none"> • To program a next access code, press the NEXT button. • To program a desired access code, press the SELECT button and then dial the number. 	
7.	Repeat step 4 to 6.	
8.	To return to the initial program mode, press the END button.	ENTER PGM CODE

While programming if a mistake is made,

1. Press the "END" button.
2. Start programming procedure from the beginning.

• You will hear the beeps after press the MEMORY button.

• The MEMORY indicator light goes on when the MEMORY button is pressed, and then Indicator light goes out when the NEXT or PREV button is pressed.

4. Return the System Program Switch to SET

■ To make program change, start from the beginning.

Date and Time

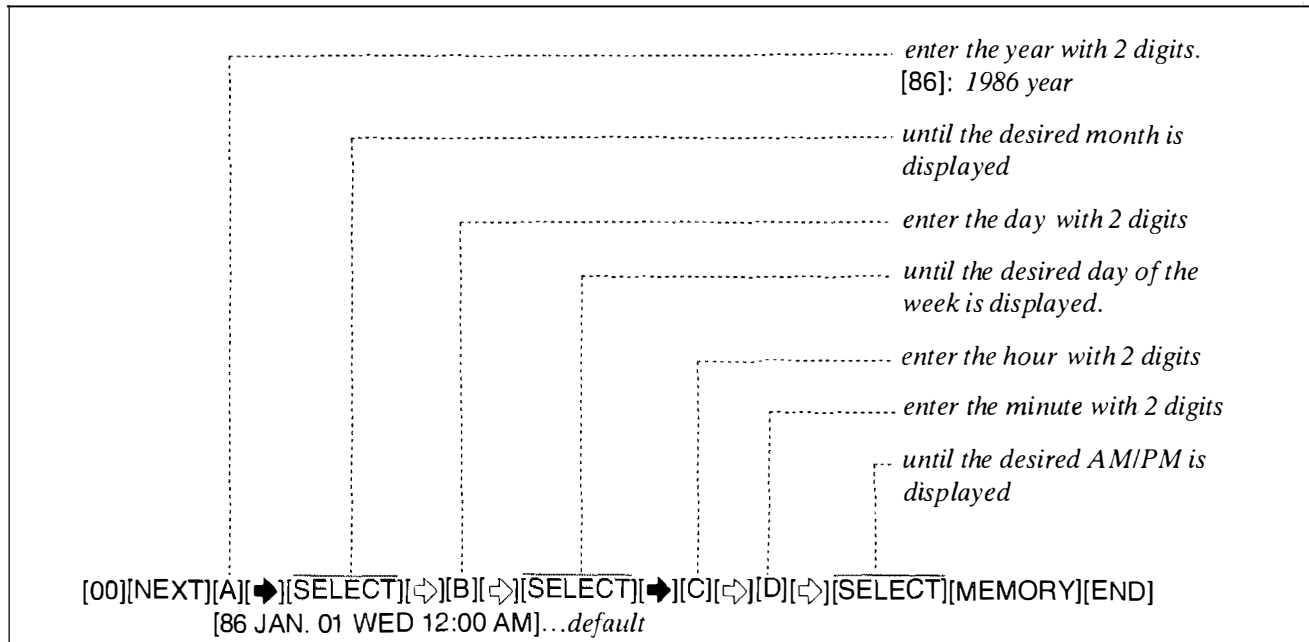

Description

Entry of the current date and time.

Programming

1. Dial (00).
"DAY/TIME SET" will be displayed.
2. Press the NEXT button.
"86 JAN. 01 WED" will be displayed and "86" will blink.
3. Enter the year (last 2 digits) using the dialing button.
4. Press the "◀" button and then repeat pressing the SELECT button until the desired month is displayed.
5. Press the "▶" button and then enter the day with 2 digits.
6. Press the "◀" button and then repeat pressing the SELECT button until the desired day of the week is displayed.

7. Press the "▶" button.
"12: 00 AM" will be displayed.
8. Enter the hour with 2 digits.
9. Press the "▶" button and then enter the minute with 2 digits.
10. Press the "◀" button and then repeat pressing the SELECT button until the desired AM/PM is displayed.
11. Press the MEMORY button.
12. To return to the initial program mode, press the END button.

Condition

- If "◀" button is pressed, the display will return to the previous sequence in the programming step.
- Instantly after pressing the MEMORY button, new time counting will start.
But LCD of extension 11 will display new time after the System Program Switch is set to SET.

System Speed Calling Entry

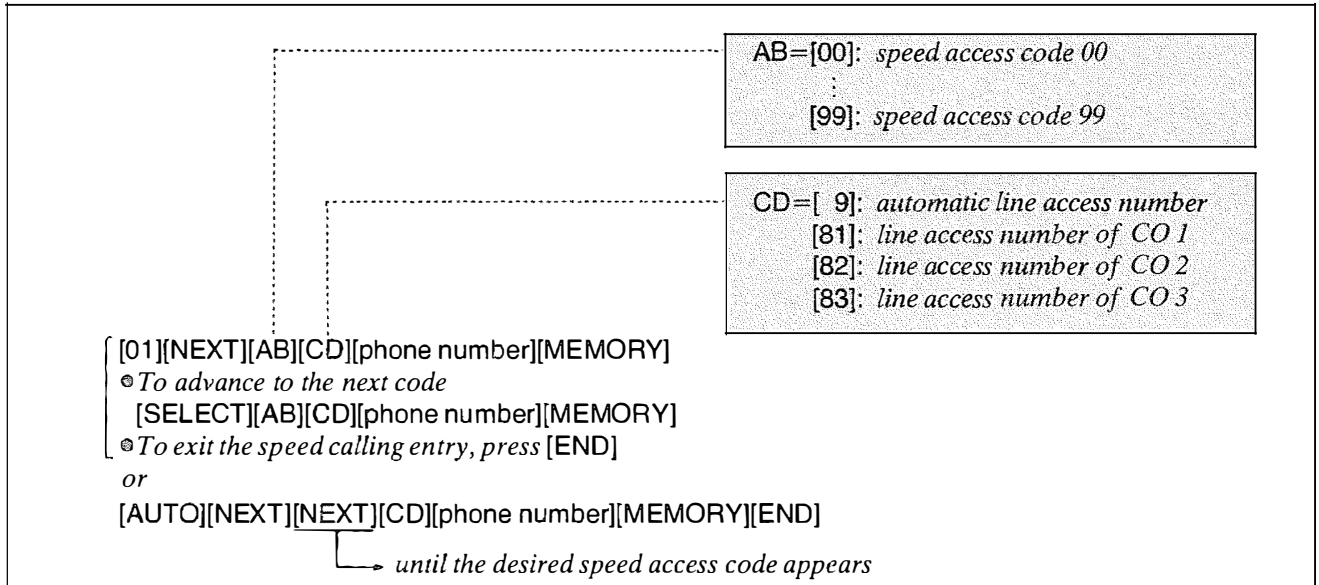

Description

100 phone numbers each with up to 32 digits may be entered into programming for speed dialing use from each extension.

Pushing the “*”, “#”, “PAUSE”, “—” or “FLASH” button counts as 1 digit.

Programming

1. Dial (01) or press the AUTO button to go into the speed dialing entry mode.
“SPEED CALLING” will be displayed.

2. Press the NEXT button.
“ENTER SPEED CODE” will be displayed.

3. Dial (00 through 99) or press the NEXT button, for speed access code entry.

Example:

When dial (00) or press the NEXT button.
• The LCD will show “00:NOT STORED” when nothing is stored in speed access code “00”. When the automatic line access number 9 and the phone number 123-456-7890 has been stored, “00: -123-456-7890” will be displayed.

4. Enter the line access number.

9: for automatic selection
81: for CO 1
82: for CO 2
83: for CO 3

5. Enter the phone number.

• You may enter punctuations during a phone number.

• To erase a wrong enter, press the CLEAR button.

6. Press the MEMORY button.

• The memory indicator will be lit.

7. To advance to the next speed access code, press the NEXT button.

To return to the previous speed access code, press the PREV button.

To program desired speed access code, press the SELECT button and then dial the speed access code.

8. Repeat steps 4 to 7.
9. To exit the speed dial entry, press the END button.
 - The LCD will show the initial program mode, "ENTER PGM CODE".

To change

Repeat steps 1 to 9.

To erase after programming

1. Dial (01) or press the AUTO button.
"SPEED CALLING" will be displayed.
2. Press the NEXT button.
"ENTER SPEED CODE" will be displayed.
3. Dial (00 through 99) or press the NEXT button, for speed access code entry.
The speed access code and the phone number will be displayed.
4. Press the CLEAR button.
5. Press the MEMORY button.
6. To advance to the next speed access code, press the NEXT button.
To return to the previous speed access code, press the PREV button.
To program desired speed access code, press the SELECT button and then dial the speed access code.
7. Repeat steps 4 to 6.
8. To exit the speed dial entry, press the END button.

Conditions

- To more the 13 digits of a phone number, use the "↵", or "⏪" button for scrolling the display.
 - The LCD will show the stored phone number.
 - The line access number (9, 81, 82 or 83) should be stored.
 - When dialing, the pause is automatically entered after line access number (9, 81, 82, or 83).
 - Continuous use of speed dialing is possible.
- Example:**
[AUTO] [01] [AUTO] [02]
In this case, speed access code "02" should not include the line access number.

There is the phone number directory on page 5-12.

Examples

1) To enter line access number 81 and telephone number 201-392-4669 into speed access code 00.

(01 NEXT 00 81- 201-392-4669 MEMORY END)

Speed access code: 00
 line access number: 81
 Telephone number: 201-392-4669

⊗ If punctuations do not enter during a phone number, LC Display will show as below.
 (00: 812013924669)

2) To enter automatic line access number 9 and telephone number 201-392-4669 into speed access code 02.

(01 NEXT 02 9- 201-392-4669 MEMORY END)

Speed access code: 02
 automatic line access number: 9
 Telephone number: 201-392-4669

3) To access MCI

(01 NEXT 01 9- 123-4567 PAUSE PAUSE 9876 201-348-7000 MEMORY END)

Speed access code: 01
 automatic line access number: 9
 MCI number: 123-4567
 PAUSE button: PAUSE PAUSE
 Security code: 9876
 Telephone number: 201-348-7000

4) To access ITT

(01 NEXT 02 81 765-4321 PAUSE PAUSE 201-348-7000 6789 MEMORY END)

Speed access code: 02
 Line access number: 81
 ITT number: 765-4321
 PAUSE button: PAUSE PAUSE
 Telephone number: 201-348-7000
 Security code: 6789

When the dialing mode is required to change a pulse mode to a tone mode. (See page 3-27)

(01 NEXT 02 82- 765-4321 * # PAUSE PAUSE 201-348-7000 6789 MEMORY END)

pulse mode: 82- 765-4321
 # button: #
 * button: *
 tone mode: 201-348-7000 6789

CO Connection Assignment

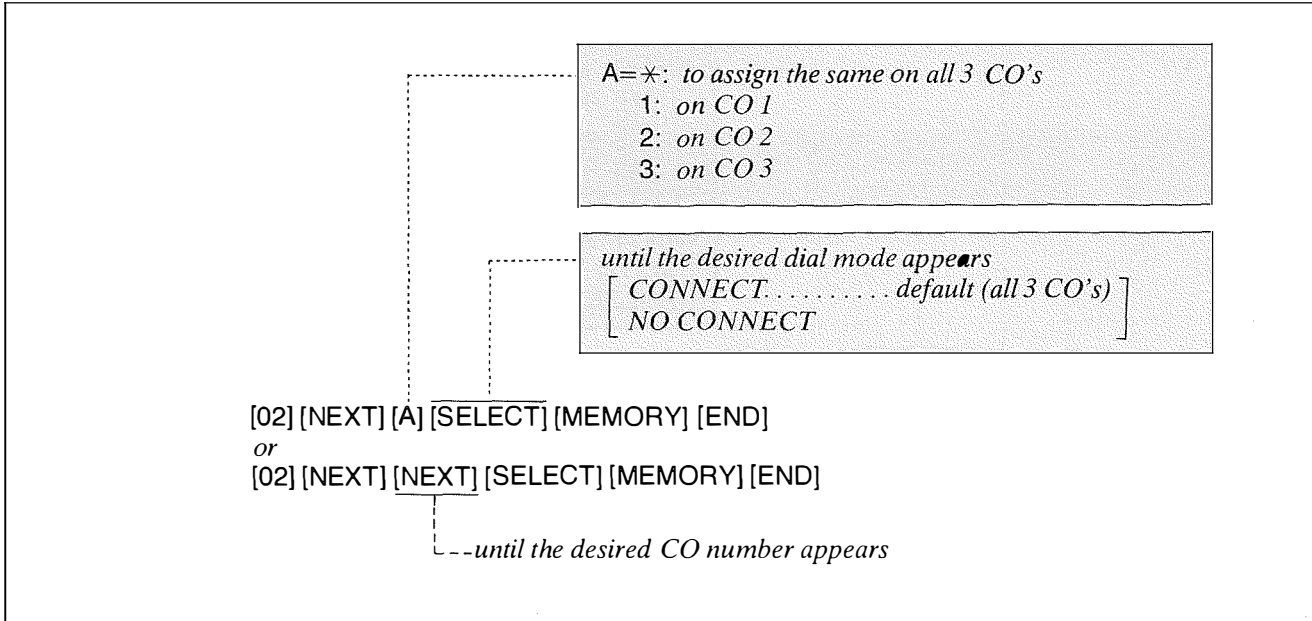

Description

You can program that which outside line is connected and which one is not connected. When an extension automatically selects an idle outside line, the extension can be connected to it quickly.

Programming

1. Dial (02).
"CO CONNECTION" will be displayed.
2. Press the NEXT button.
"ENTER CO NO" will be displayed.
3. Press the NEXT button.
"CO 1: CONNECT" will be displayed and "CONNECT" will blink.
4. Press the SELECT button, to alternate between CONNECT and NO CONNECT to select the desired mode.
5. Press the MEMORY button.
The blinking LCD will stop.
6. Repeat steps 3 to 5, to program the dialing mode on the other CO lines.
7. To return to the initial program mode, press the END button.

Conditions

When you start the programming from step 1, you may dial the desired CO number instead of the NEXT button at step 3.

- The PREV button allows you to see the entry status in the previous CO connection assignment.

Example:

CO 1 and 2 CONNECT
CO 3 NO CONNECT

1. [02] [NEXT] [(NEXT) or (1)] [MEMORY]
2. [NEXT] [MEMORY]
3. [NEXT] [SELECT] [MEMORY] [END]

Programming Table

See page 5-14.

Dial Mode (Tone/Pulse) Selection

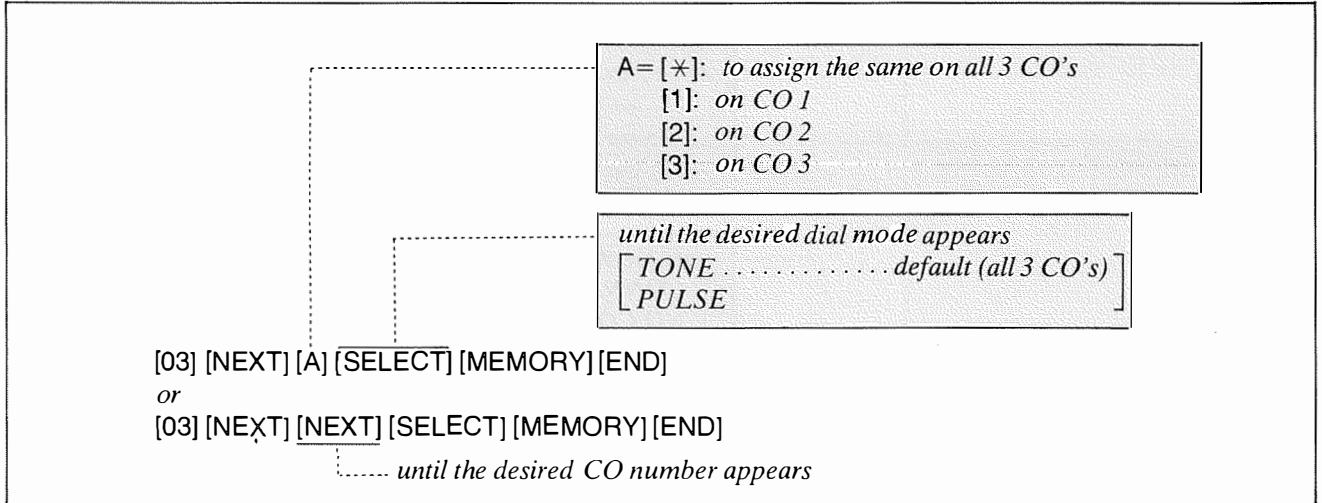

Description

Allows the user to select the dialing mode (tone or pulse) on each CO (Central Office) Line.

•TONE Dial Mode

The dial signal from the extension (with tone or pulse dial mode) will be converted to TONE. TONE will then be transmitted to the Central Office.

•PULSE Dial Mode

The dial signal from the extension (with tone or pulse dial mode) will be converted to PULSE. PULSE will then be transmitted to the Central Office.

Programming

1. Dial (03).
"CO DIAL MODE" will be displayed.
2. Press the NEXT button.
"ENTER CO NO" will be displayed.
3. Press the NEXT button.
"CO 1: TONE" will be displayed and "TONE" will blink.
4. Press the SELECT button to alternate between TONE and PULSE.
5. Press the MEMORY button.
The blinking LCD will stop.
6. Repeat steps 3 to 5, to program the dialing mode on the other central office lines.
7. To return to the initial program mode, press the END button.

Conditions

When you start the programming from step 1, you may dial the desired CO number instead of the NEXT button at step 3.

- The PREV button allows you to see the entry status in the previous CO dial mode.
- If your extension is not a KX-T30830 or KX-T30820 but a standard telephone, and the dialtone frequency of CO Lines is 600 Hz, the KX-T30810 is used for only pulse dial mode of CO Lines.
- If the KX-T30810 is connected to the Central Office directly or installed behind a host PBX, which receives both tone and pulse dialing mode, the KX-T30810 must be used only in the tone dial mode.

Programming Table

See page 5-14.

Switching Mode (Day/Night Service)

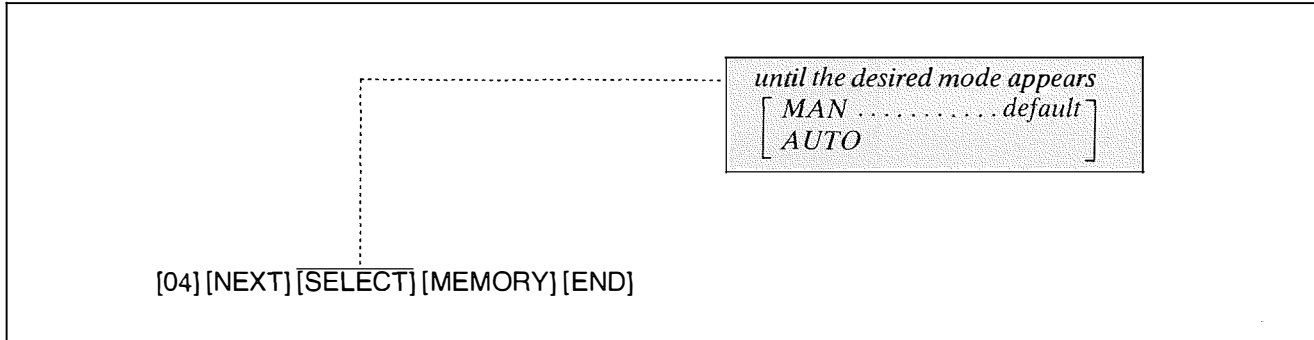

Description

Allows Day/Night service to be selected manually or automatically.

In case of manual switching, refer to “Flexible Night Service” page 3-35.

In case of automatic switching, set the “Starting Time (Day/Night Service)” page 2-11.

The following features should be set.

- “Flexible Day Outward Dialing Assignment” page 2-13
- “Flexible Night Outward Dialing Assignment” page 2-14
- “Flexible Day Ringing Assignment” page 2-15
- “Flexible Night Ringing Assignment” page 2-16

Programming

1. Dial (04).
“DAY/NIGHT MODE” will be displayed.
2. Press the NEXT button.
“MODE CHANGE:MAN” will be displayed and “MAN” will blink.
3. Press the SELECT button to alternate between “MAN” and “AUTO” to select the desired mode.
4. Press the MEMORY button.
The blinking LCD will stop.
5. To return to the initial program mode, press the END button.

Conditions

When the Switching mode (Day/Night Service) is set to “AUTO”, the present Day/Night Service mode doesn’t change just after you programmed. To change the present mode, manual operation is required.

After you selected the Starting time (Day/Night Service) page 2-11, select the present Day/Night mode by “Flexible Night Service” page 3-35.

Programming Table

See page 5-14.

Starting Time (Day/Night Service)

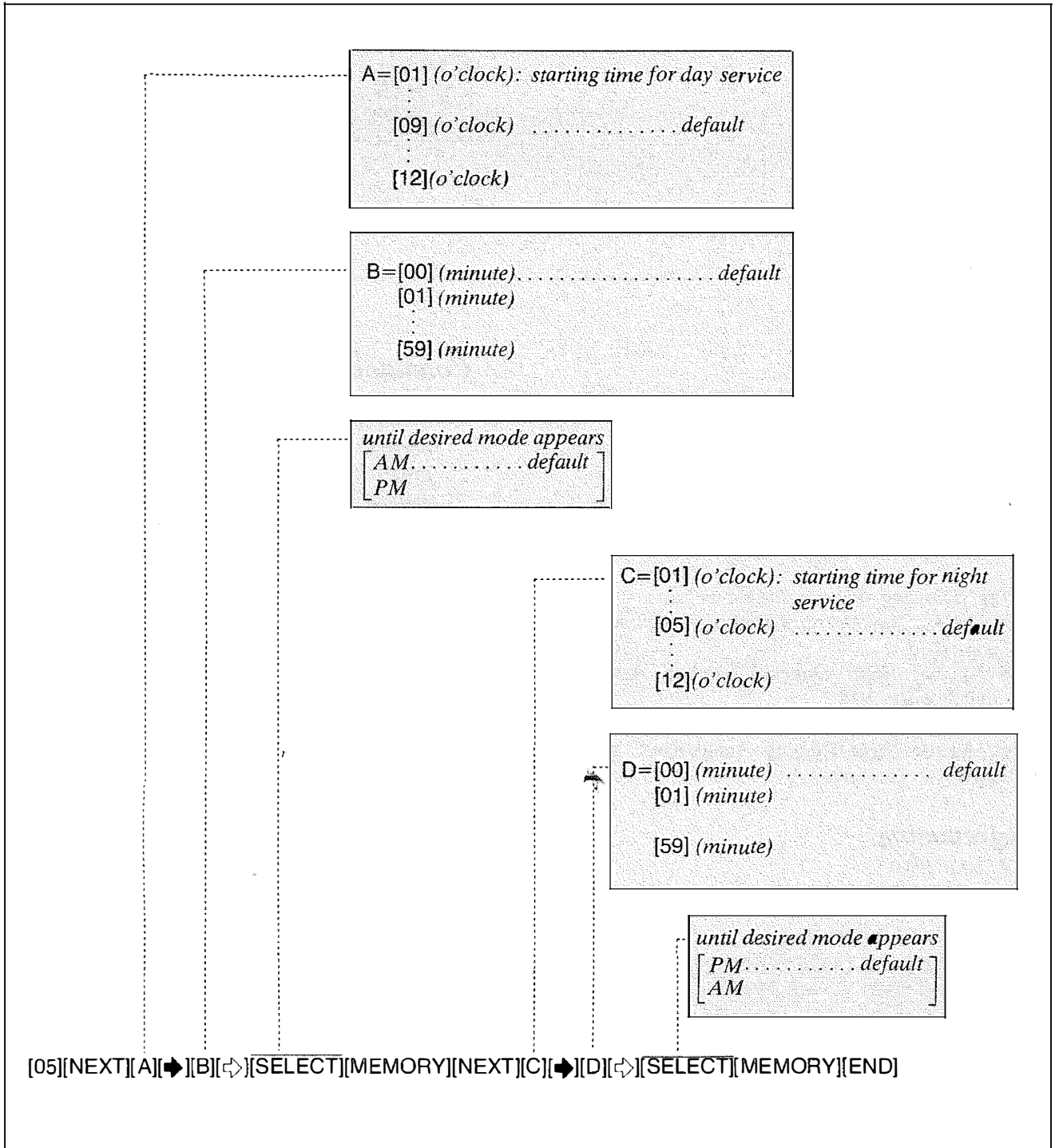

Description

If you select automatic switching mode for day/night service, enter a starting time. Refer to "Switching Mode (Day/Night Service)" page 2-10.

Programming

1. Dial (05).
"DAY/NIGHT TIME" will be displayed.
2. Press the NEXT button.
"DAY: 09:00 AM" will be displayed as a default value and "09" will blink.
3. Enter a starting time for day service using 2 digits.
4. Press the "↵" button.
"00" will blink.
5. Enter the minute using 2 digits.
6. Press the "↵" button.
"AM" will blink.
7. Press the SELECT button to alternate between "AM" and "PM" to select the correct setting.
8. Press the MEMORY button.
9. Press the NEXT button.
"NIGHT: 05:00 PM" will be displayed as a default value and "05" will blink.
10. Enter a starting time for night service using 2 digits.
11. Press the "↵" button.
"00" will blink.
12. Enter the minute using 2 digits.
13. Press the "↵" button.
"PM" will blink.
14. Press the SELECT button to alternate between "AM" and "PM" to select the correct setting.
15. Press the MEMORY button.
16. To return to the initial program mode, press the END button.

Conditions

- If the NEXT button is pressed at step 3 through 7, the display will advance to the "Night Time input" mode (step 9). The operations of step 3 through 7 are not stored.
- If the PREV button is pressed at step 10 through 14, the display will return to the "day time input" mode (step 2). The operations of step 10 through 14 are not stored.

Example:

8:30 AM... starting time for day plan
6:30 PM... starting time for night plan

[05][NEXT][08][↵][30][↵][MEMORY][NEXT][06]
[↵][30][↵][MEMORY][END]

Programming Table

See page 5-14.

Flexible Day Outward Dialing Assignment

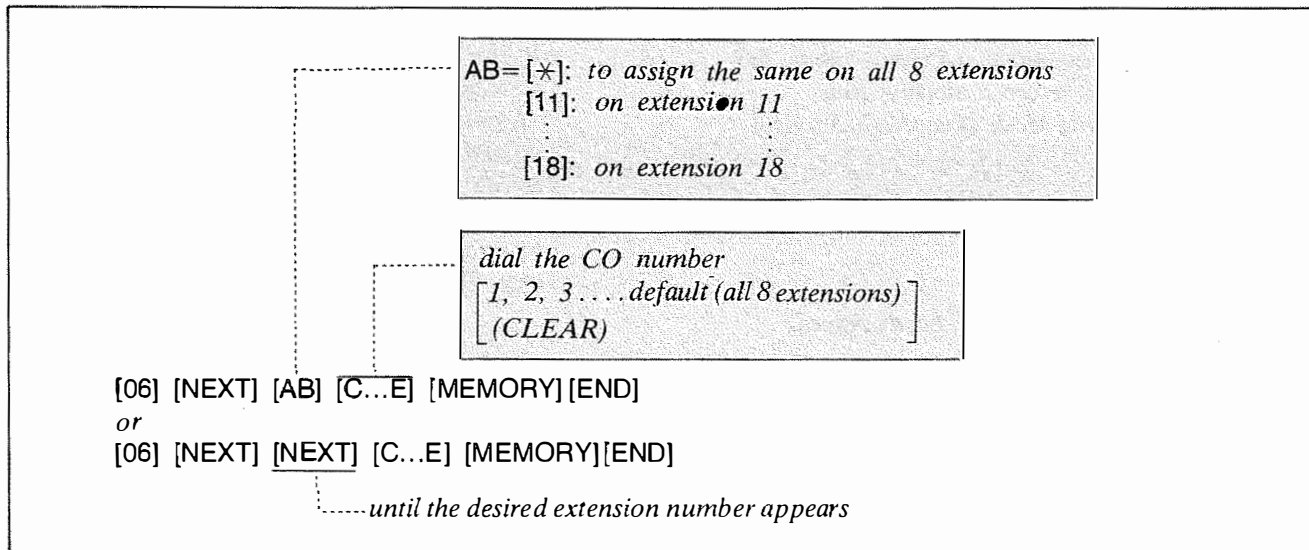

Description

Through programming, you can select which extensions may be used for outward dialing by using the day mode of operation.

Programming

1. Dial (06).
"DAY: OUT CO" will be displayed.
2. Press the NEXT button.
"ENTER EXT NO" will be displayed.
3. Press the NEXT button.
"11: CO 1, 2, 3" will be displayed and "1, 2, 3" will blink.
4. Dial the CO number to be entered.
The desired combination of CO Lines will be displayed.
[To prohibit dialing, press the CLEAR button instead of CO number.
"11: CO....." will be displayed.]
5. Press the MEMORY button.
The blinking LCD will stop.
6. Repeat steps 3 to 5, to program the assignment on the other extensions.
7. To return to the initial program mode, press the END button.

Conditions

When you start the programming from step 1, you may dial the desired extension number instead of the NEXT button at step 3.

- The PREV button allows you to go to the previous extension for displaying the CO assignment.

Example: COMPANY XYZ

Company XYZ wants only extension 11 and 15 to have access to CO 1, 2 and 3 on outgoing calls during the day. Extensions 12, 13, 14, 16, 17 and 18 are to be programmed for access to only CO 1 and 2.

1. [06] [NEXT] [(NEXT) or (11)] [1] [2] [3] [MEMORY]
2. [NEXT] [1] [2] [MEMORY]
3. [NEXT] [1] [2] [MEMORY]
4. [NEXT] [1] [2] [MEMORY]
5. [NEXT] [1] [2] [3] [MEMORY]
6. [NEXT] [1] [2] [MEMORY]
7. [NEXT] [1] [2] [MEMORY]
8. [NEXT] [1] [2] [MEMORY] [END]

Programming Table

See page 5-14.

Flexible Night Outward Dialing Assignment

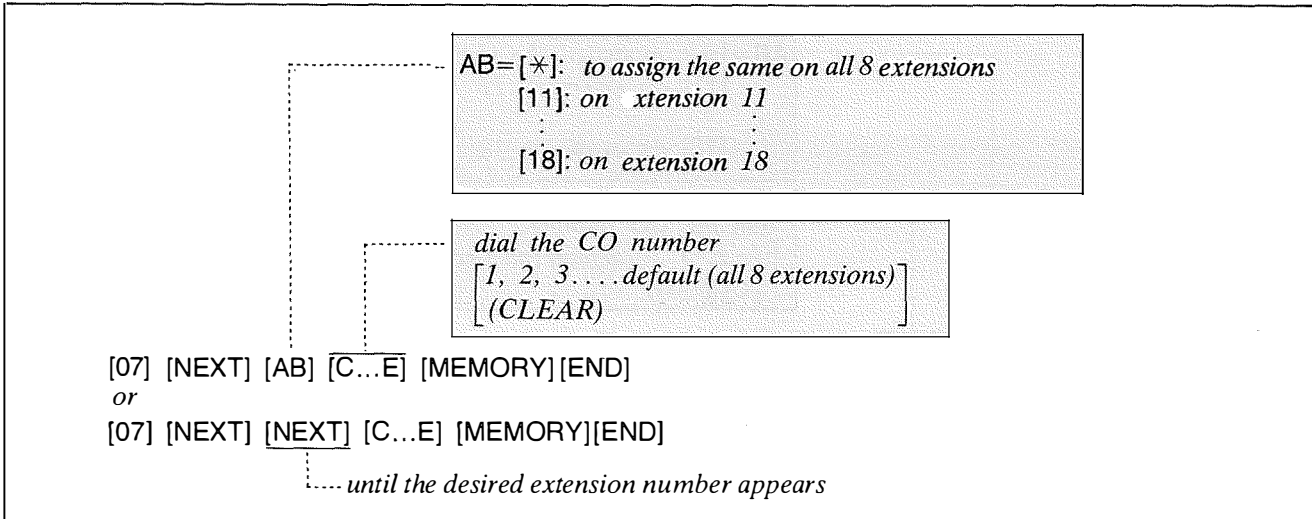

Description

Through programming, you can select which extensions may be used for outward dialing by using the night mode of operation.

Programming

1. Dial (07).
 "NIGHT: OUT CO" will be displayed.
2. Press the NEXT button.
 "ENTER EXT NO." will be displayed.
 prompt entering extension number.
3. Press the NEXT button.
 "11: CO 1, 2, 3" will be displayed and "1, 2, 3" will blink.
4. Dial the CO numbers to be entered.
 The desired combination of CO Lines will be displayed.
 [To prohibit dialing, press the CLEAR button instead of CO number.
 "11: CO....." will be displayed.
5. Press the MEMORY button.
 The blinking LCD will stop.
6. Repeat steps 3 to 5, to program the assignment on the other extensions.
7. To return to the initial program mode, press the END button.

Conditions

When you start the programming from step 1, you may dial the desired extension number instead of the NEXT button at step 3.
 • The PREV button allows you to go to the previous extension for displaying the CO assignment.

Example: COMPANY XYZ

Company XYZ wants extensions 11, 13 and 16 to have access to CO 1, 2 and 3 on outgoing calls during the night. Extensions 12, 14, 15, 17 and 18 are to be programmed for access to only CO 1 and 2.

1. [07] [NEXT] [(NEXT) or (11)] [1] [2] [3] [MEMORY]
2. [NEXT] [1] [2] [MEMORY]
3. [NEXT] [1] [2] [3] [MEMORY]
4. [NEXT] [1] [2] [MEMORY]
5. [NEXT] [1] [2] [MEMORY]
6. [NEXT] [1] [2] [3] [MEMORY]
7. [NEXT] [1] [2] [MEMORY]
8. [NEXT] [1] [2] [MEMORY] [END]

Programming Table

See page 5-14.

Flexible Day Ringing Assignment

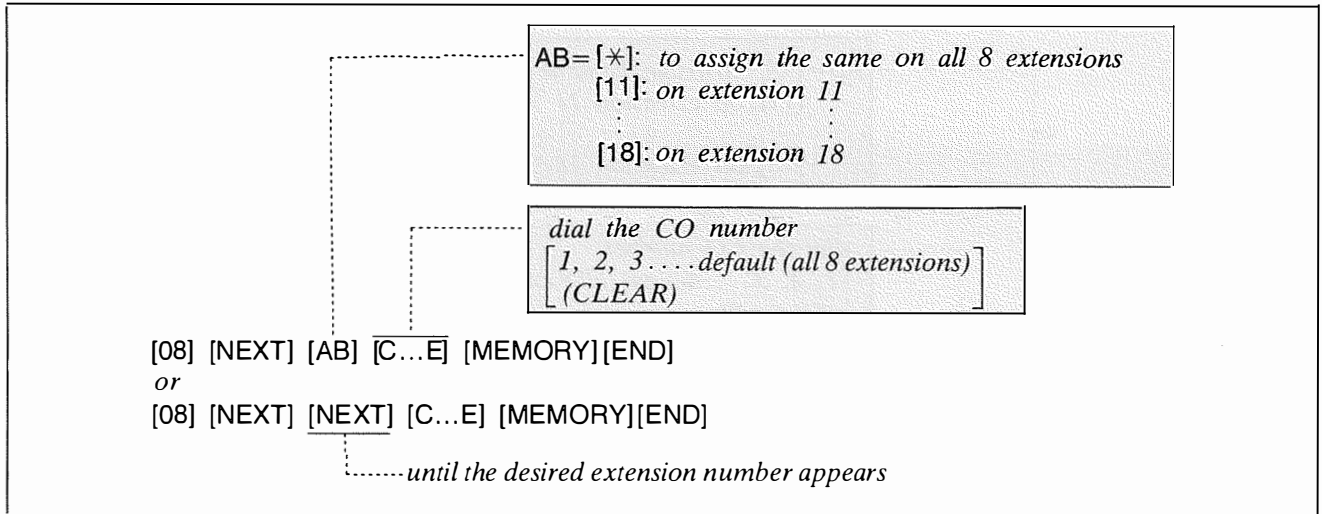

Description

Through programming, you can select which extensions will ring on incoming calls from the Central Office during the day time.

Programming

1. Dial (08).
"DAY: IN CO" will be displayed.
2. Press the NEXT button.
"ENTER EXT NO" will be displayed.
3. Press the NEXT button.
"11: CO 1, 2, 3" will be displayed and "1, 2, 3" will blink.
4. Dial the CO numbers to be entered.
The desired combination of CO Line will be displayed.

To prohibit ringing, press the CLEAR button instead of CO number.
 "11: CO....." will be displayed.
5. Press the MEMORY button.
The blinking LCD will stop.
6. Repeat steps 3 to 5, to program the assignment on the other extensions.
7. To return to the initial program mode, press the END button.

Conditions

When you start the programming from step 1, you may dial the desired extension number instead of the NEXT button at step 3.
 • The PREV button allows you to go to the previous extension for displaying the CO assignment.

Example:

Incoming calls from Central Office during the day are programmed to ring at extension 11 only.

1. [08] [NEXT] [*] [CLEAR] [MEMORY]
2. [NEXT] [1] [2] [3] [MEMORY] [END]

Extensions	To make program change							
	11	12	13	14	15	16	17	18
CO 1	×							
CO 2	×							
CO 3	×							

Programming Table

See page 5-15.

Flexible Night Ringing Assignment

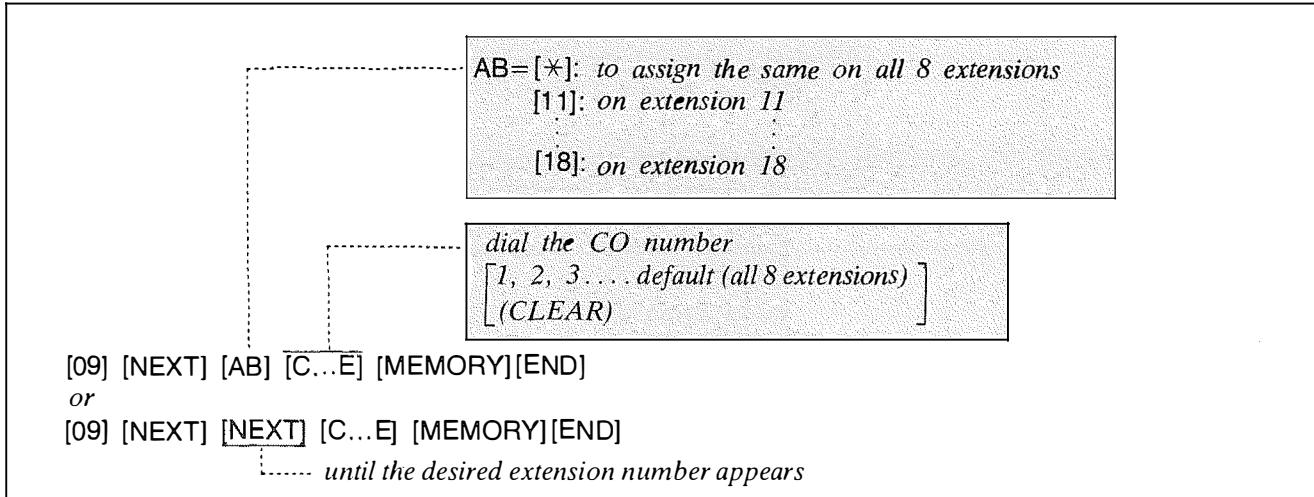

Description

Through programming, you can select which extensions will ring during the night time on incoming calls from the Central Office.

Programming

1. Dial (09).
"NIGHT: IN CO" will be displayed.
2. Press the NEXT button.
"ENTER EXT NO" will be displayed.
3. Press the NEXT button.
"11: CO 1, 2, 3" will be displayed and "1, 2, 3" will blink.
4. Dial the CO numbers to be entered.
The desired combination of CO Line will be displayed.
 [To prohibit ringing, press the CLEAR button instead of CO number.
 "11: CO....." will be displayed.]
5. Press the MEMORY button.
The blinking LCD will stop.
6. Repeat steps 3 to 5, to program the assignment of the other extensions.
7. To return to the initial program mode, press the END button.

Conditions

When you start the programming from step 1, you may dial the desired extension number instead of the NEXT button at step 3.

- The PREV button allows you to go to the previous extension for displaying the CO assignment.

Example: COMPANY XYZ

Company XYZ would like all incoming calls to ring at all extensions during the nighttime.

[09] [NEXT] [*] [1][2][3] [MEMORY] [END]

Extensions	To make program change							
	11	12	13	14	15	16	17	18
CO 1	x	x	x	x	x	x	x	x
CO 2	x	x	x	x	x	x	x	x
CO 3	x	x	x	x	x	x	x	x

Programming Table

See page 5-15.

Toll Restriction—Class Assignment

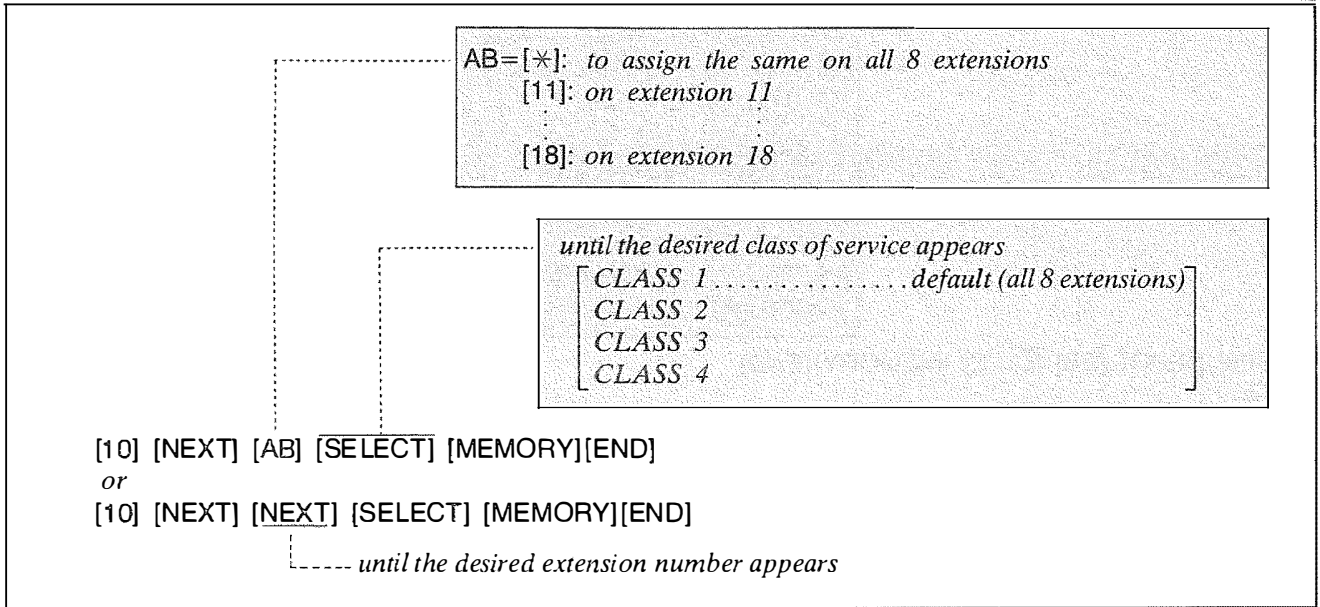

Description

Used to prohibit selected extensions from making long distance calls.

Toll restriction can help eliminate telephone abuse and contribute to controlling telephone costs.

There are four service of classes available for each extension.

	Service Class Selections	
	Allowed	Denied
1	all calls	/
2	toll calls, local calls	international calls
3	local calls, selected area-codes	international calls, any calls other than specific area-code programmed
4	local calls	international calls, toll calls

*For Service Class 3, up to 10 area codes can be selected for use in toll dialing (See "Toll Restriction—Area Code Selection" on page 2-19).

Programming

1. Dial (10).
"TOLL RESTRICTION" will be displayed.
2. Press the NEXT button.
"ENTER EXT NO" will be displayed.
3. Press the NEXT button.
"11: CLASS 1" will be displayed and "1" will blink.
4. Repeat pressing the SELECT button until the desired class is displayed.
5. Press the MEMORY button.
The blinking LCD will stop.
6. Repeat steps 3 to 5, to program the assignment on the other extensions.
7. To return to the initial program mode, press the END button.

Conditions

When you start the programming from step 1, you may dial the desired extension number instead of the NEXT button at step 3.

⊗The PREV button allows you to go to the previous extension for displaying the service class assignment.

⊗Some area is need to insert a dial "1" before dialing the area code for long distance call. If your area is not need to insert a dial "1", the Programmable Toll Prefix should be set to "WITHOUT 1".

Refer to "Programmable Toll Prefix" page 2-36.

Example:

⊗To prohibit international calls on extension 13 but allow local and toll calls enter.

[10] [NEXT] [13] [SELECT] [MEMORY]
[END]

or

[10] [NEXT] [NEXT] [NEXT] [NEXT]
[SELECT] [MEMORY][END]

⊗To prohibit international calls and toll calls on extension 14 but to allow local calls.

[10] [NEXT] [14] [SELECT] [SELECT]
[SELECT] [MEMORY][END]

or

[10] [NEXT] [NEXT] [NEXT] [NEXT]
[NEXT] [SELECT] [SELECT] [SELECT]
[MEMORY] [END]

Extensions	To make program change							
	11	12	13	14	15	16	17	18
Class 1 (all calls)								
Class 2 (toll calls, local calls)			x					
Class 3 (selected area-codes, local calls)								
Class 4 (local calls)				x				

Programming Table

See page 5-15.

Toll Restriction—Area Code Selection

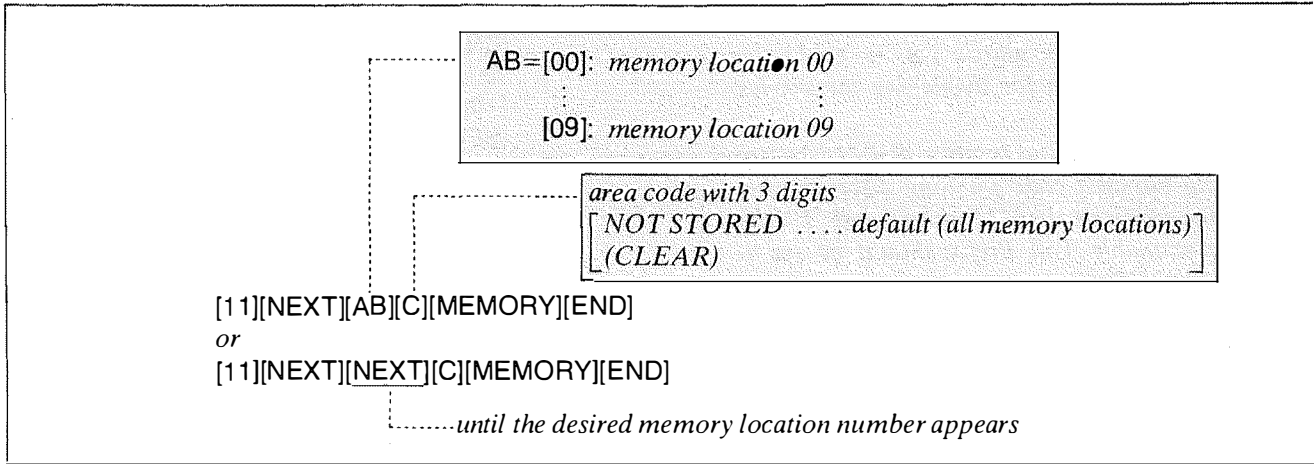

Description

For Service Class 3 (see “Toll Restriction—Class Assignment” on page 2-17.), up to 10 area codes can be selected for use in toll dialing. All area codes except those entered will be denied. All extensions programmed for Service Class Selections 3 shall be assigned to the same area code selection plan.

Programming

When Service Class 3 is programmed;

1. Dial (11).
“RESTRC AREA CODE” will be displayed.
2. Press the NEXT button.
“ENTER CODE NO.” will be displayed.
3. Dial (00 through 09) or press the NEXT button.
Example:
When dial (00) or press the NEXT button.
• The LCD will show “00:NOT STORED” when nothing is stored in memory location number “00”.
When the area code 212 has been stored, “00:212” will be displayed.
4. Dial the area code, with 3 digits.
• To erase a wrong enter, press the CLEAR button.
5. Press the MEMORY button.
• The memory indicator will be lit.

6. To advance to the next memory location number, press the NEXT button.
To return to the previous memory location number, press the PREV button.
To go to the desired memory location number, press SELECT button and the dial the memory location number.
7. Repeat steps 4 to 6.
8. To return to the initial program mode, press the END button.

Example:

To allow extension 12 to access to New York City and entire state of New Jersey, program the following.
New York City has 2 area codes 212, 718 and New Jersey 201, 609.
Enter 212 into the memory location number “00”, 718 into “01”, 201 into “02” and 609 into “03”.

STEP 1...[10] [NEXT] [NEXT] [SELECT]
[SELECT] [MEMORY][END]

STEP 2...[11][NEXT][NEXT][212][MEMORY]
[NEXT][718][MEMORY]
[NEXT][201][MEMORY]
[NEXT][609][MEMORY][END]

	Memory location number									
	00	01	02	03	04	05	06	07	08	09
area code entry	212	718	201	609						

Programming Table

See page 5-15.

Programmable Operator Call

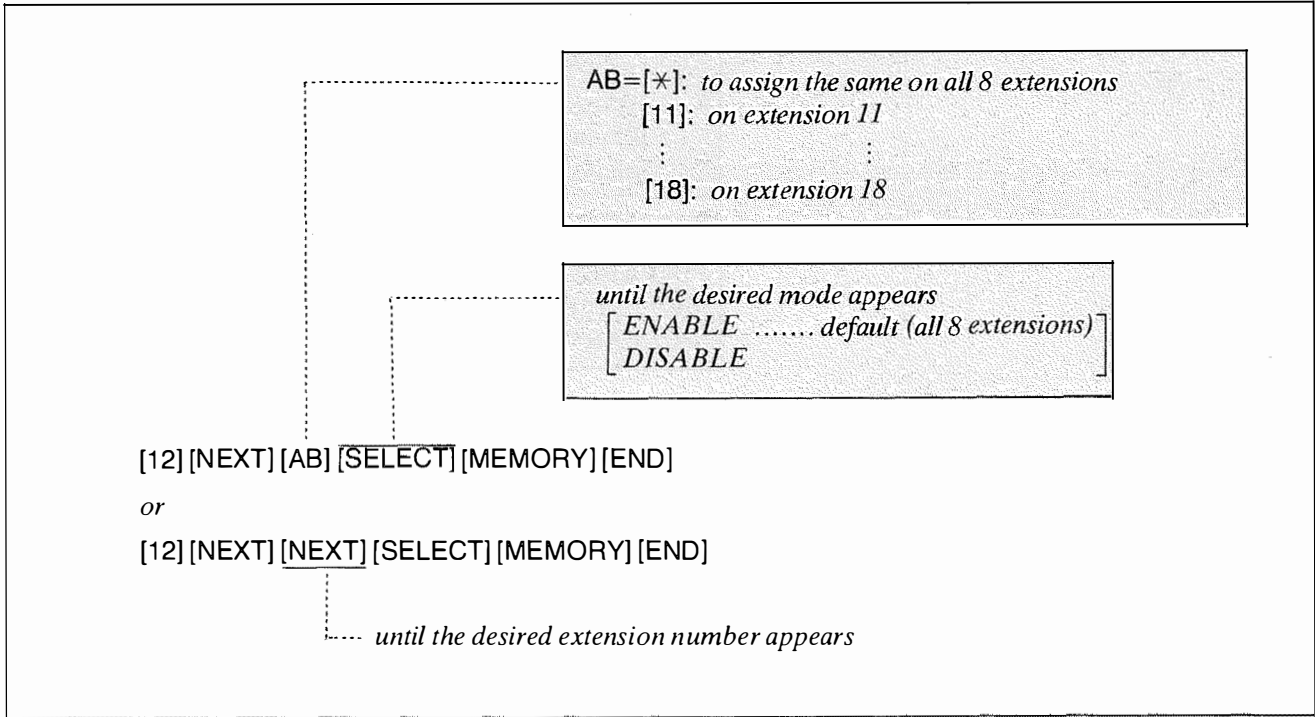

Description

Through programming, you can select which extensions may be dialed Operator Call. For to deny all the dialing that start from "0", set to *DISABLE*.

Programming

1. Dial (12).
"OPERATOR CALL" will be displayed.
2. Press the *NEXT* button.
"ENTER EXT NO" will be displayed.
3. Press the *NEXT* button.
"11: ENABLE" will be displayed and "ENABLE" will blink.
4. Press the *SELECT* button, to alternate between *ENABLE* and *DISABLE* to select the desired mode.
5. Press the *MEMORY* button.
The blinking LCD will stop.
6. Repeat steps 3 to 5, to program the assignment of the other extensions.
7. To return to the initial program mode, press the *END* button.

Conditions

When you start the programming from step 1, you may dial the desired extension number instead of the *NEXT* button at step 3.

- The *PREV* button allows you to go to the previous extension for displaying the operator call selection.
- Operator call dialing can not deny service class 1 of Toll Restriction.

Example:

- To prohibit operator call on extension 12

[12] [NEXT] [12] [SELECT] [MEMORY] [END]

	To make program change							
	11	12	13	14	15	16	17	18
Enable								
Disable		x						

Programming Table

See page 5-15.

Host PBX Access Codes Assignment

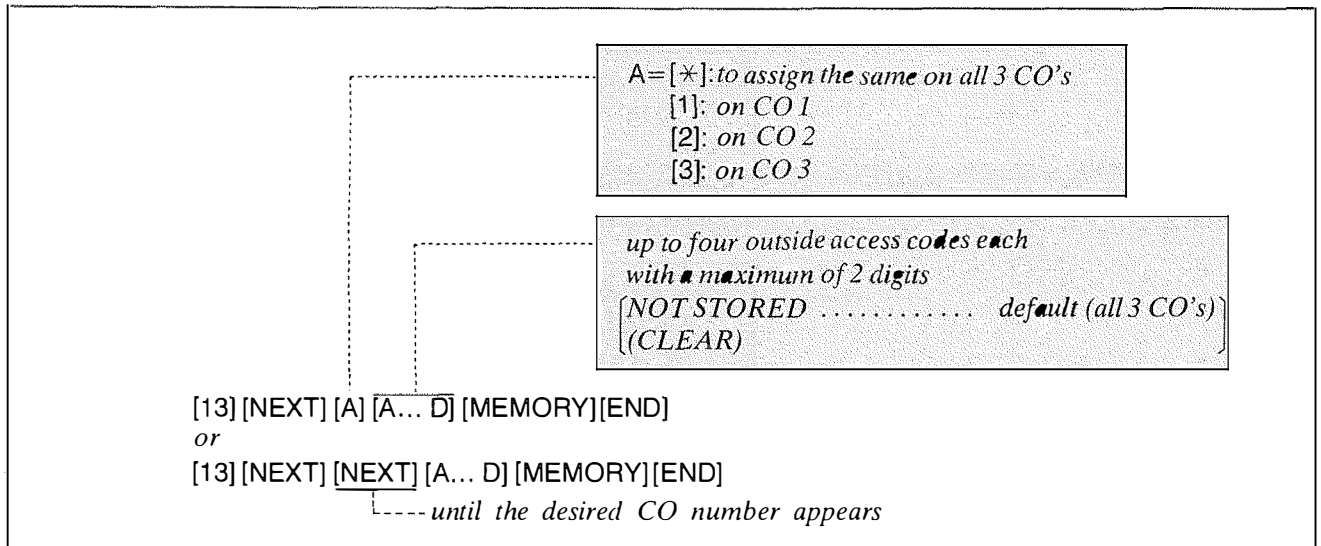

Description

When the system, KX-T30810, is installed behind a host PBX, the host PBX may require a pause time to access Central Office Lines. This feature enables the host PBX to automatically pause via programming the outward dialing access codes of the host PBX.

6. Repeat steps 3 to 5 to program each of the CO's of the KX-T30810.

7. To return to the initial program mode, press the END button.

Programming

1. Dial (13).
 "HOST PBX ACCESS" will be displayed.
2. Press the NEXT button.
 "ENTER CO NO" will be displayed.
3. Press the NEXT button.
 • The LCD will show "CO1: NOT STORED" when nothing is stored in CO1. When the outside access codes 81, 82 has been stored, "CO1:81, 82" will be displayed.
4. Enter up to four outward access codes each with a maximum of 2 digits, punctuating each code with the [,] button.
 • To erase a wrong enter, press the CLEAR button.
5. Press the MEMORY button.

Conditions

When you start the programming from step 1, you may dial the desired CO number instead of the NEXT button at step 3.

- The PREV button allows you to go to the previous CO for displaying the host PBX access codes assignment.

Example:

- Access codes 81, 82, 83, 9 on the CO1=
 [13] [NEXT] [1] [81] [,] [82] [,] [83] [,] [9]
 [MEMORY] [END]
 or
 [13] [NEXT] [NEXT] [81] [,] [82] [,] [83] [,] [9]
 [MEMORY] [END]

CO	outward access codes of PBX			
1	81	82	83	9
2				
3				

Programming Table

See page 5-15.

Automatic Answering (Automatic/Manual) Selection

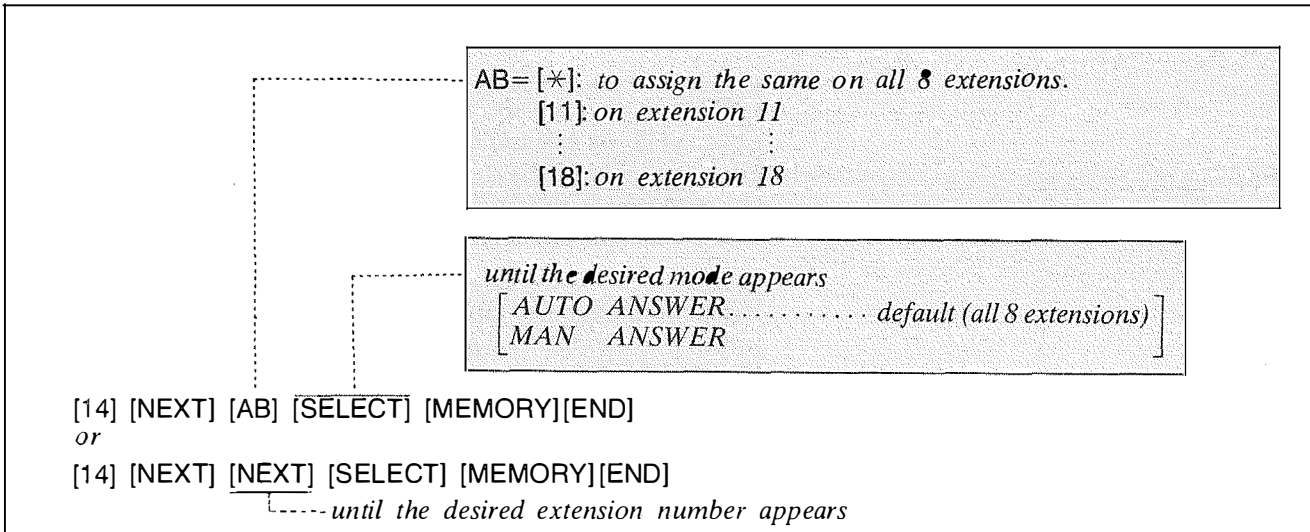

Description

By programming either automatic or manual answering can be set. The auto mode allows the user to answer incoming outside calls simply by lifting the handset, while if programmed to the manual mode, the user must lift the handset and press the flashing CO button.

Programming

1. Dial (14).
"CO ANSWER MODE" will be displayed.
2. Press the NEXT button.
"ENTER EXT NO" will be displayed.
3. Press the NEXT button.
"11: AUTO ANSWER" will be displayed and "AUTO" will blink.
4. Press the SELECT button to alternate between AUTO ANSWER and MAN ANSWER to select the desired mode.
5. Press the MEMORY button.
The blinking LCD will stop.
6. Repeat steps 3 to 5, to program the mode selection of the other extensions.
7. To return to the initial program mode, press the END button.

Conditions

When you start the programming from step 1, you may dial the desired extension number instead of the NEXT button at step 3.

- The PREV button allows you to go to the previous extension for displaying the automatic answering selection.

Examples:

- AUTO ANSWER mode on the extension 11
[14] [NEXT] [11] [MEMORY][END]
or
[14] [NEXT] [NEXT] [MEMORY][END]
- MANUAL ANSWER mode on the extension 12
[14] [NEXT] [12] [SELECT] [MEMORY][END]
or
[14] [NEXT] [NEXT] [NEXT] [SELECT] [MEMORY][END]

	To make program change							
	11	12	13	14	15	16	17	18
Automatic	x							
Manual		x						

Programming Table

See page 5-15.

Preferred Line Assignment

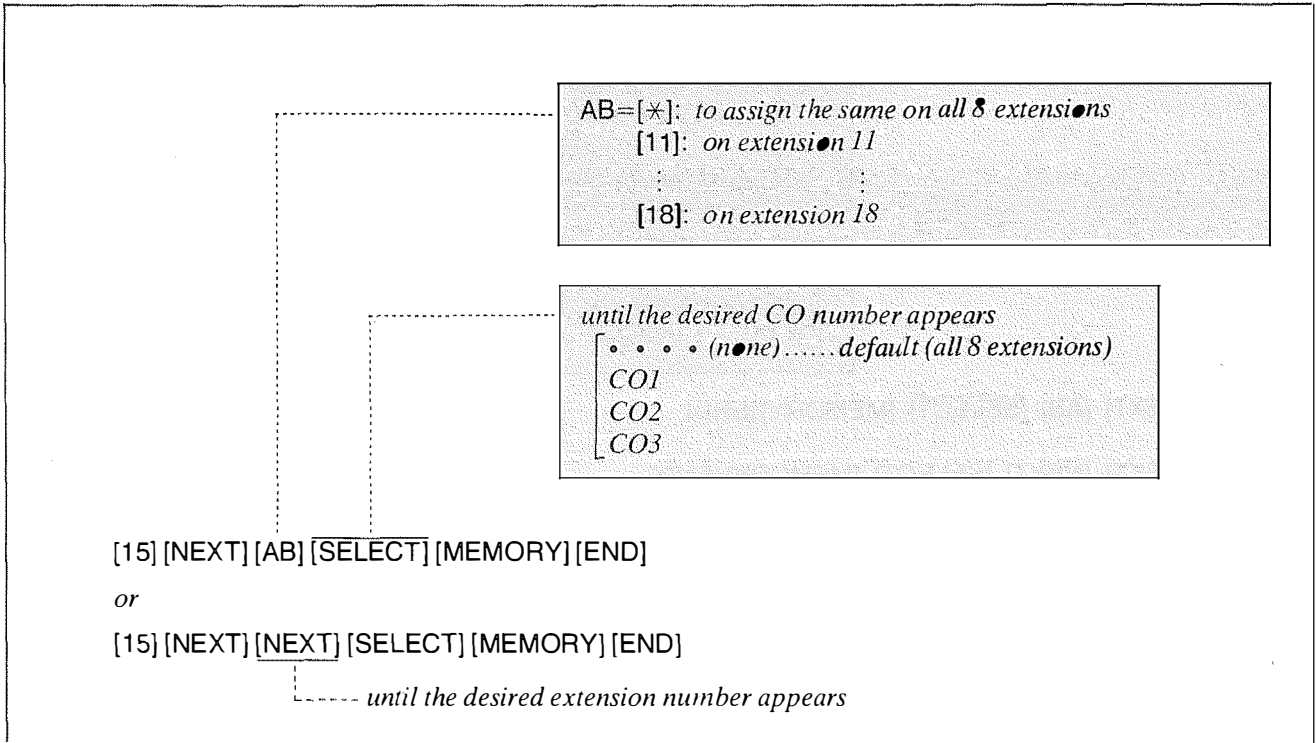

Description

When any incoming calls from the Central Office are received at the same time, you can receive the call on the preferred line.

Programming

1. Dial (15).
"PREFERRED LINE" will be displayed.
2. Press the NEXT button.
"ENTER EXT NO" will be displayed.
3. Press the NEXT button.
"11: ••••" will be displayed and
"••••" will blink.
4. Repeat pressing the SELECT button until the desired CO number is displayed.
5. Press the MEMORY button.
The blinking LCD will stop.
6. Repeat steps 3 to 5, to program the assignment of the other extensions.
7. To return to the initial program mode, press the END button.

Conditions

When you start the programming from step 1, you may dial the desired extension number instead of the NEXT button at step 3.

- The PREV button allows you to go to the previous extension for displaying the preferred line assignment.

Programming Table

See page 5-16.

Programmable Call Waiting

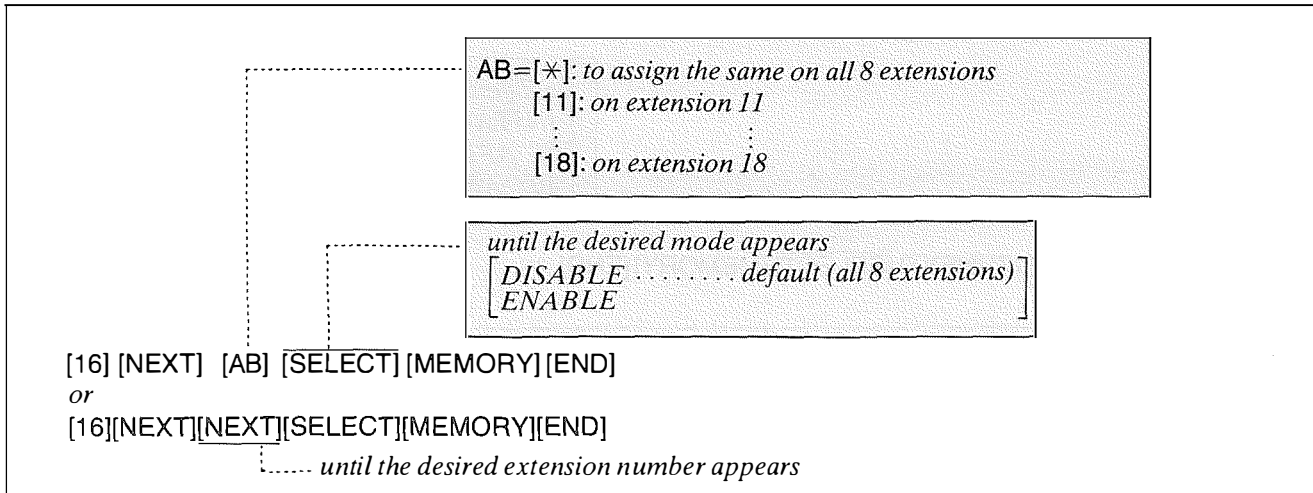

Description

During a conversation, call waiting tone will be heard when the third party on the outside or intercom calls you. Call waiting tone can be removed or added at customer's request. Set to "ENABLE" for call waiting.

5. Press the MEMORY button.
The blinking LCD will stop.

6. Repeat steps 3 to 5, to program the assignment of the other extensions.

7. To return to the initial program mode, press the END button.

Programming

1. Dial (16).
"CALL WAITING" will be displayed.
2. Press the NEXT button.
"ENTER EXT NO" will be displayed.
3. Press the NEXT button.
"11: DISABLE" will be displayed and "DISABLE" will blink.
4. Press the SELECT button, to alternate between ENABLE and DISABLE to select the desired mode.

Conditions

- When you start the programming from step 1, you may dial the desired extension number instead of the NEXT button at step 3.
- The PREV button allows you to go to the previous extension for displaying the call waiting selection.

Programming Table

See page 5-16.

Duration Time Count Start Mode

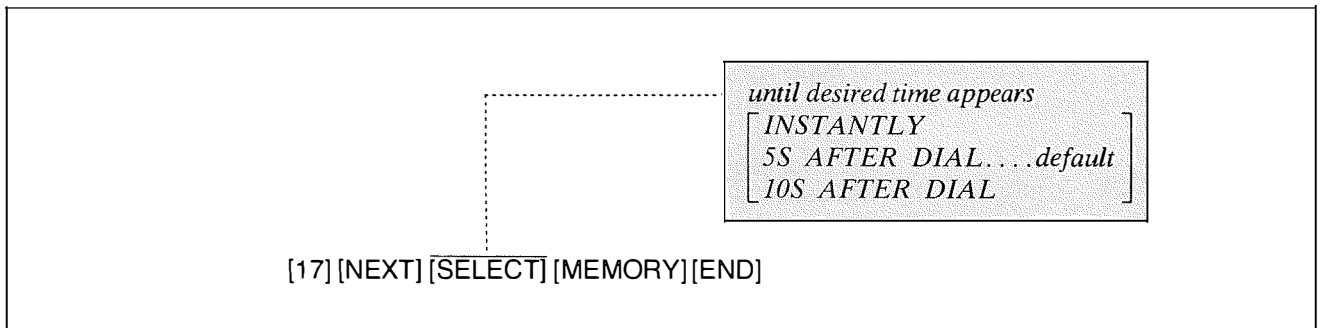

Description

The duration time of the conversation is displayed.

Program the start time of the timing.

- Instantly after the CO line is captured.
- 5 seconds after the dialing
- 10 seconds after the dialing

Example:

10 seconds after the dialing

= [17] [NEXT] [SELECT] [MEMORY] [END]

Programming Table

See page 5-16.

Programming

1. Dial (17).
 - "DURAT-TIME CQUNT" will be displayed.
2. Press the NEXT button.
 - "5S AFTER DIAL" will be displayed and blink.
3. Repeat pressing the SELECT button until the desired time (INSTANTLY, 5S AFTER DIAL, 10S AFTER DIAL) is displayed.
4. Press the MEMORY button.

The blinking LCD will stop.
5. To return to the initial program mode, press the END button.

Hookswitch Flash Timing

A=[*]: to assign the same on all 3 CO's
 [1]: on CO 1
 [2]: on CO 2
 [3]: on CO 3

until the desired flash timing appears
 [300 MS
 600 MS default (all 3 CO's)
 900 MS]

[18] [NEXT] [A] [SELECT] [MEMORY] [END]
 or
 [18] [NEXT] [NEXT] [SELECT] [MEMORY] [END]

--- until the desired CO number appears

Description

The timing of the hookswitch flash signal must be within the requirements from your Central Office.
 There are three choices available 0.3, 0.6 or 0.9 second.

Conditions

When you start the programming from step 1, you may dial the desired CO number instead of the NEXT button at step 3.

- The PREV button allows you to go to the previous CO for displaying the hookswitch flash timing.

Programming

1. Dial (18).
 "FLASH TIME SET" will be displayed.
2. Press the NEXT button.
 "ENTER CO NO" will be displayed.
3. Press the NEXT button.
 "CO 1: 600 MS" will be displayed and "600 MS" will blink.
4. Repeat pressing the SELECT button until the desired value is displayed.
5. Press the MEMORY button.
 The blinking LCD will stop.
6. Repeat steps 3 to 5, to set the hookswitch timing of the other CO's.
7. To return to the initial program mode, press the END button.

Example:

- 0.3 sec on all 3 CO=
 [18] [NEXT] [*] [SELECT] [SELECT] [MEMORY] [END]

CO (s)	To make program change		
	1	2	3
300 msec	x	x	x
600 msec			
900 msec			

Programming Table

See page 5-16.

Disconnect Time

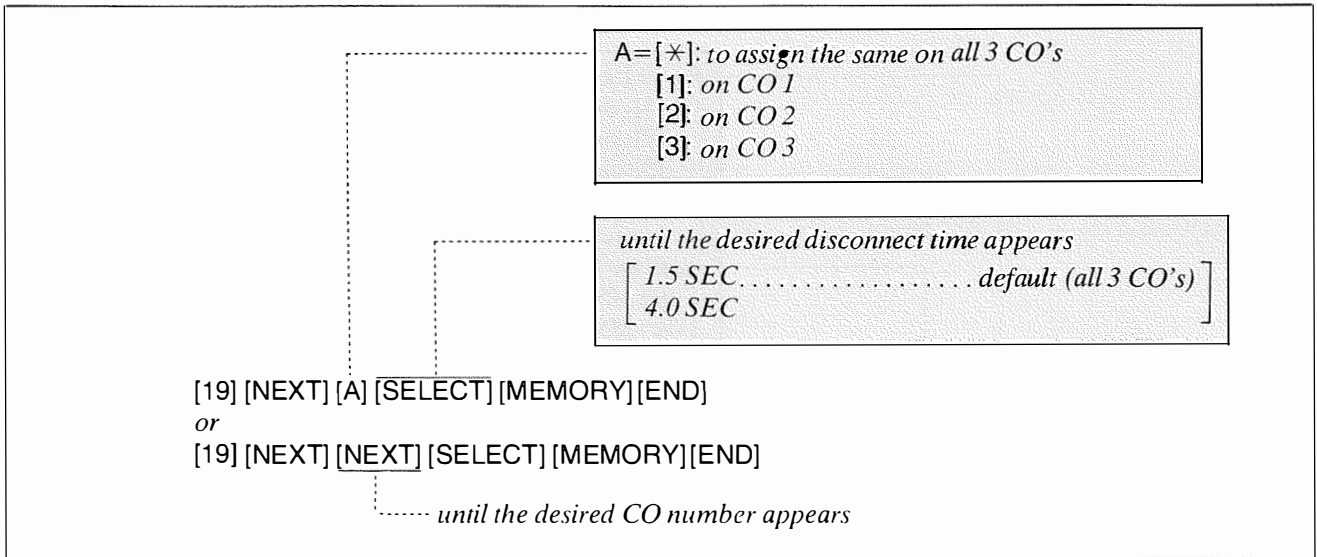

Description

A certain amount of time is needed for a outside call to be released, this is necessary so that new calls may be attempted after disconnecting with the previous calls.

There are two choices available, 1.5 and 4.0 seconds.

The time you select must be longer than the requirements from your Central Office or host PBX.

Programming

1. Dial (19).
"DISCONNECT TIME" will be displayed.
2. Press the NEXT button.
"ENTER CO NO" will be displayed.
3. Press the NEXT button.
"CO 1: 1.5 SEC" will be displayed and "1.5 SEC" will blink.
4. Press the SELECT button to alternate between 1.5 sec and 4.0 sec.
5. Press the MEMORY button.
The blinking LCD will stop.

6. Repeat steps 3 to 5, to set the disconnect time for the other CO's.

7. To return to the initial program mode, press the END button.

Conditions

When you start the programming from step 1, you may dial the desired CO number instead of the NEXT button at step 3.

- The PREV button allows you to go to the previous CO for displaying the disconnect time.

Example:

- 4.0 sec on all 3 CO=
[19] [NEXT] [*] [SELECT] [MEMORY] [END]

	To make program change		
CO(s)	1	2	3
1.5 sec			
4.0 sec	x	x	x

Programming Table

See page 5-16.

Calling Party Control (CPC) Signal

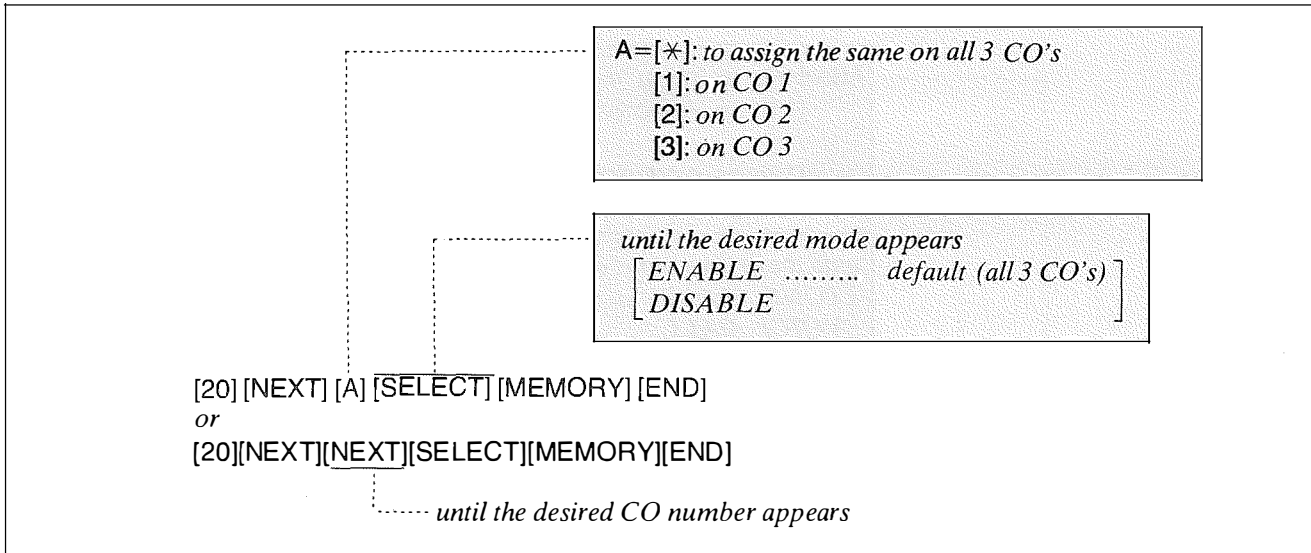

Description

To detect that an outside party has hung up and then terminate the outside (after a conversation, conference etc.) a CPC signal is needed. CPC signal can be removed or added at customer's request.

Programming

1. Dial (20).
"CPC DETECTION" will be displayed.
2. Press the NEXT button.
"ENTER CO NO" will be displayed.
3. Press the NEXT button.
"CO 1: ENABLE" will be displayed and "ENABLE" will blink.
4. Press the SELECT button, to alternate between ENABLE and DISABLE to select the desired mode.
5. Press the MEMORY button.
The blinking LCD will stop.

6. Repeat steps 3 to 5, to program the assignment of the other CO's.
7. To return to the initial program mode, press the END button.

Conditions

- When you start the programming from step 1, you may dial the desired CO number instead of the NEXT button at step 3.
- The PREV button allows you to go to the previous CO for displaying the calling party control signal selection.

Programming Table

See page 5-16.

Intercom Alerting Mode

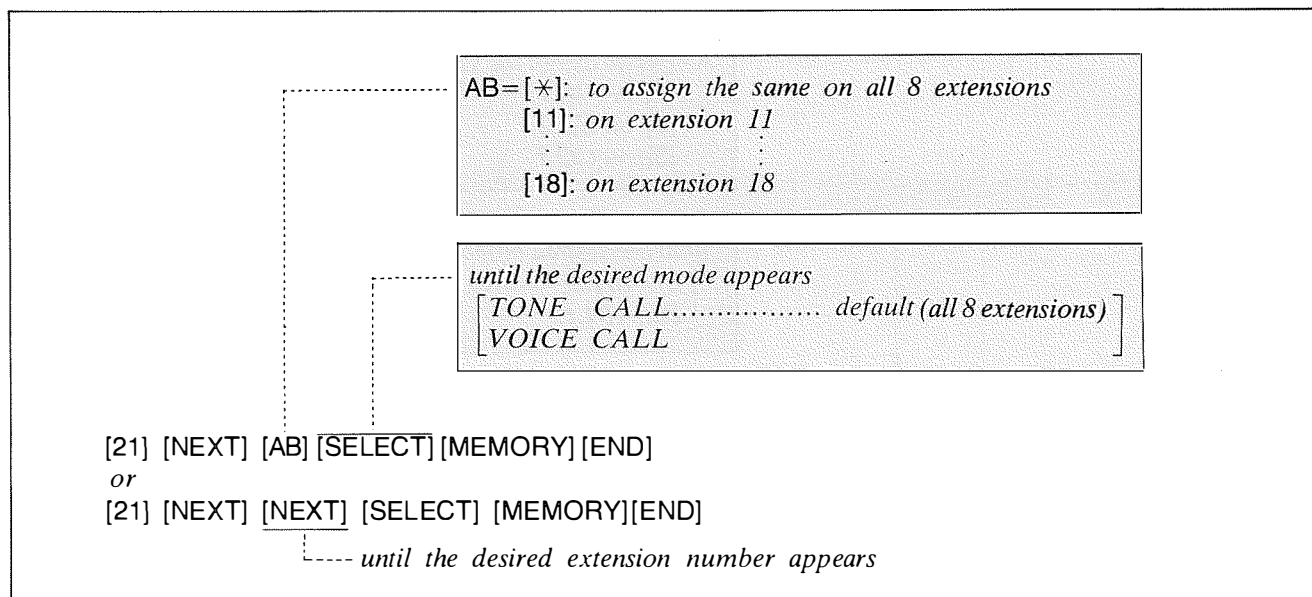

Description

The intercom alerting mode (tone alerting/voice alerting) at a receiving extension can be selected through programming.

TONE... Tone alerting (ringing) sounds at the receiving extension.

VOICE... Voice alerting instead of Tone alerting is heard through the speaker on the receiving extension.

Programming

1. dial (21).
"INTCOM CALL MODE" will be displayed.
2. Press the NEXT button.
"ENTER EXT NO" will be displayed.
3. Press the NEXT button.
"11: TONE CALL" will be displayed and "TONE" will blink.
4. Press the SELECT button to alternate between TONE CALL and VOICE CALL to select the desired mode.
5. Press the MEMORY button.
The blinking LCD will stop.
6. Repeat steps 3 to 5 to program the call mode of the other extensions.
7. To return to the initial program mode, press the END button.

Conditions

When you start the programming from step 1, you may dial the desired extension number instead of the NEXT button at step 3.

- The PREV button allows you to go to the previous extension for displaying the alerting mode.

Example:

- VOICE CALL on the extension 13
 [21] [NEXT] [13] [SELECT] [MEMORY] [END]

	To make program change							
Extensions	11	12	13	14	15	16	17	18
Tone call								
Voice call			×					

Programming Table

See page 5-16.

Programmable Doorphone

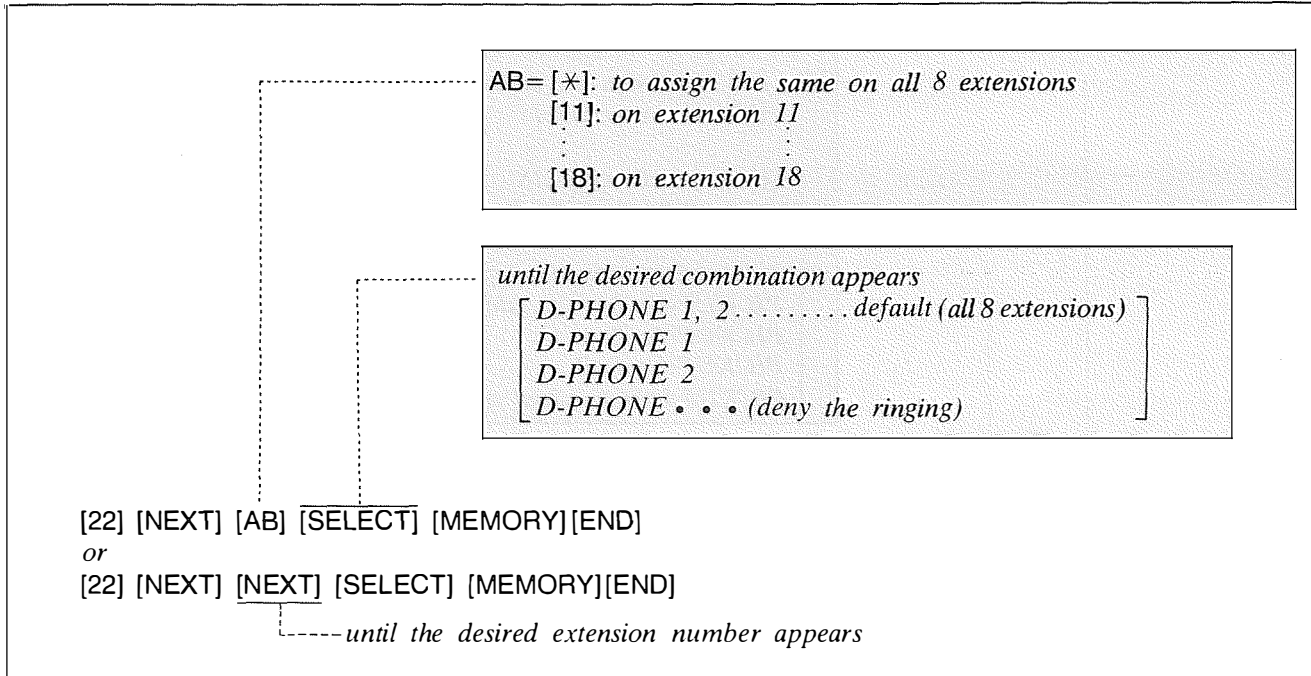

Description

Allows each extension to be programmed for receiving calls from up to 2 doorphones. A doorphone is option.

Programming

1. Dial (22).
"DOOR PHONE RCV" will be displayed.
2. Press the NEXT button.
"ENTER EXT NO" will be displayed.
3. Press the NEXT button.
"11: D-PHONE 1, 2" will be displayed and "1, 2" will blink.
4. Repeat pressing the SELECT button until the desired combination of doorphones (which are to be connected to that extension) is displayed.
5. Press the MEMORY button.
The blinking LCD will stop.
6. Repeat steps 3 to 5, to program the combination of the other extensions.
7. To return to the initial program mode, press the END button.

Conditions

When you start the programming from step 1, you may dial the desired extension number instead of the NEXT button at step 3.

- The PREV button allows you to go to the previous extension for displaying the doorphone assignment.

Example:

- To allow extension 12 to receive from D-PHONE 2
 [22] [NEXT] [12] [SELECT] [SELECT]
 [MEMORY] [END]

	To make program change							
	11	12	13	14	15	16	17	18
Extensions								
Doorphone 1								
Doorphone 2		×						

Programming Table

See page 5-16.

Dial Call Pickup Group Assignment

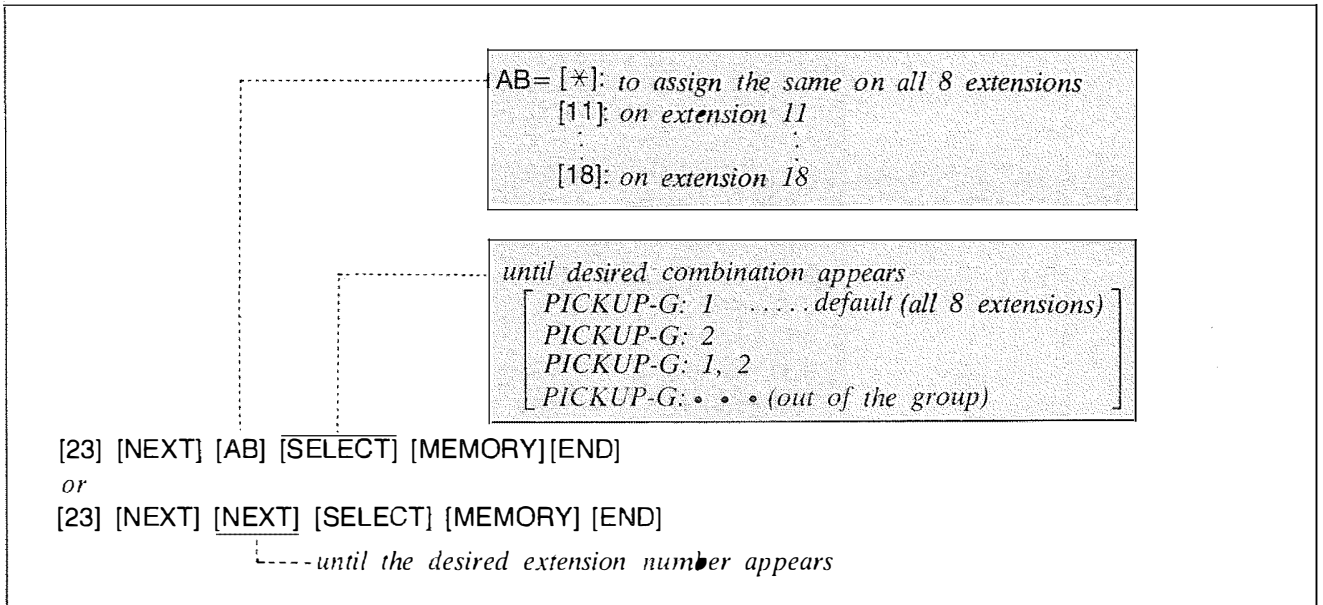

Description

Permits an extension user to answer other ringing telephones, provided that they are in the same pickup group.

Programming

1. Dial (23).
 "PICKUP GROUP" will be displayed.
2. Press the NEXT button.
 "ENTER EXT NO" will be displayed.
3. Press the NEXT button.
 "11: PICKUP-G: 1" will be displayed and "1" will blink. This means that extension 11 belongs to pickup group 1.
4. Repeat pressing the SELECT button until the desired group combination is displayed.
5. Press the MEMORY button.
 The blinking LCD will stop.
6. Repeat steps 3 to 5, to program the assignment of the other extensions.
7. To return to the initial program mode, press the END button.

Conditions

- Each extension may belong to more than one pickup group, up to two, or does not belong to the group.
- When you start the programming from step 1, you may dial the desired extension number instead of the NEXT button at step 3.
- The PREV button allows you to go to the previous extension for displaying the pickup group assignment.

Examples:

- extension 14...Pickup Group 1
 [23] [NEXT] [14] [MEMORY][END]
- extension 15...Pickup Group 2
 [23] [NEXT] [15] [SELECT] [MEMORY] [END]

	To make program change							
	11	12	13	14	15	16	17	18
Extensions								
Pickup Group 1				×				
Pickup Group 2					×			
Out of the group								

Programming Table

See page 5-17.

Busy Tone Selection

[24] [NEXT] [SELECT] [MEMORY][END]

until the desired mode appears
TONE:1 default
TONE:2

Description

For telephone instruments that have automatic busy tone detection, it is suggested that busy tone type (1) is to be used.

Selection of busy tone type (1) insures that the camp-on feature of the Panasonic ITS phones will operate.

Conditions

- Because Panasonic ITS phones are equipped with automatic busy tone detection in the speakerphone mode, calls will be terminated upon hearing a busy tone signal of tone type (2) therefore camp-on feature will not be activated.

Programming Table

See page 5-17.

Programming

1. Dial (24).
"BUSY TONE SELECT" will be displayed.
2. Press the NEXT button.
"TONE: 1" will be displayed and "1" will blink.
3. Press the SELECT button to alternate between "TONE:1" and "TONE:2".
4. Press the MEMORY button.
The blinking LCD will stop.
5. To return to the initial program mode, press the END button.

Hold Time Reminder

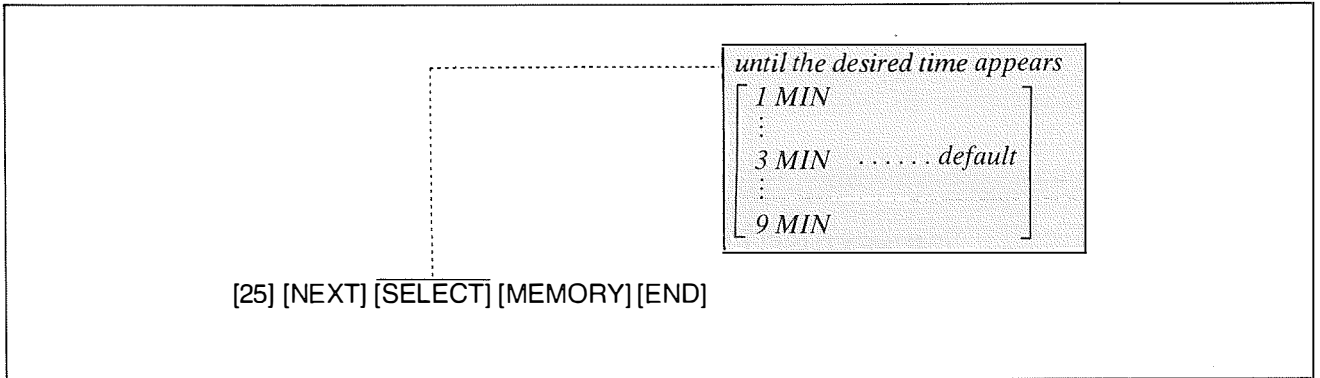

Description

A tone indication will be heard at the holding extension to remind user that he still has a call on hold.

The reminder will be sounded after 3 minutes but can be changed.

There are 9 choices ranging from (1) minute to (9).

4. Press the *MEMORY* button.
The blinking LCD will stop.

5. To return to the initial program mode, press the *END* button.

Conditions

The hold time reminder is activated, even if the hold recall time set is programmed to "DIS-ABLE".

Programming

1. Dial (25).
"AUTO HOLD ALARM" will be displayed.
2. Press the *NEXT* button.
"TIME: 3 MIN" will be displayed and "3" will blink.
3. Repeat pressing the *SELECT* button until the desired time is displayed.

Example:

4 minutes = [25] [NEXT] [SELECT]
[MEMORY] [END]

	minutes								
	1	2	3	4	5	6	7	8	9
To make program change				×					

Programming Table

See page 5-17.

Hold Recall Time Set

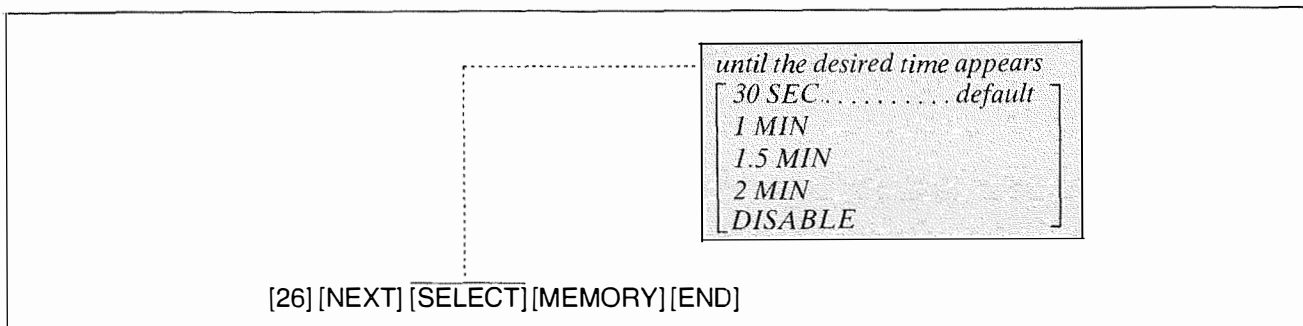

Description

When the handset of the holding extension is replaced on calls, you may have automatic hold recall after the desired time elapses. The hold recall time set can be removed or added at customer's request.

Example:

1.5 minutes=[26] [NEXT] [SELECT]
 [SELECT] [MEMORY][END]

	30 seconds	1 minute	1 minute 30 seconds	2 minutes	disable
To make program change			×		

Programming

1. Dial (26).
 "HOLD RECALL TIME" will be displayed.
2. Press the NEXT button.
 "TIME: 30 SEC" will be displayed and "30 SEC" will blink.
3. Repeat pressing the SELECT button until the desired time (30 SEC, 1 MIN, 1.5 MIN, 2 MIN, DISABLE) is displayed.
4. Press the MEMORY button.
 The blinking LCD will stop.
5. To return to the initial program mode, press the END button.

Programming Table

See page 5-17.

Programmable External Paging Access Tone

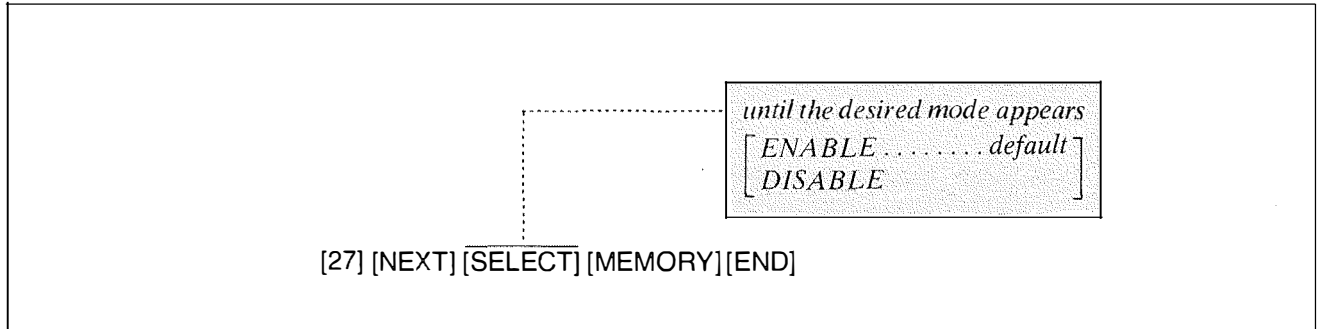

Description

The acknowledge tone that is heard after accessing the external paging can be removed or added at the customer's request.

Example:

To eliminate the paging access tone.

[27] [NEXT] [SELECT] [MEMORY][END]

Programming

1. Dial (27).
"EXT-PAG ACK-TONE" will be displayed.
2. Press the NEXT button.
"ENABLE" will be displayed and blink.
3. Press the SELECT button to alternate between ENABLE and DISABLE to select the desired mode.
4. Press the MEMORY button.
The blinking LCD will stop.
5. To return to the initial program mode, press the END button.

Programming Table

See page 5-17.

Programmable Toll Prefix

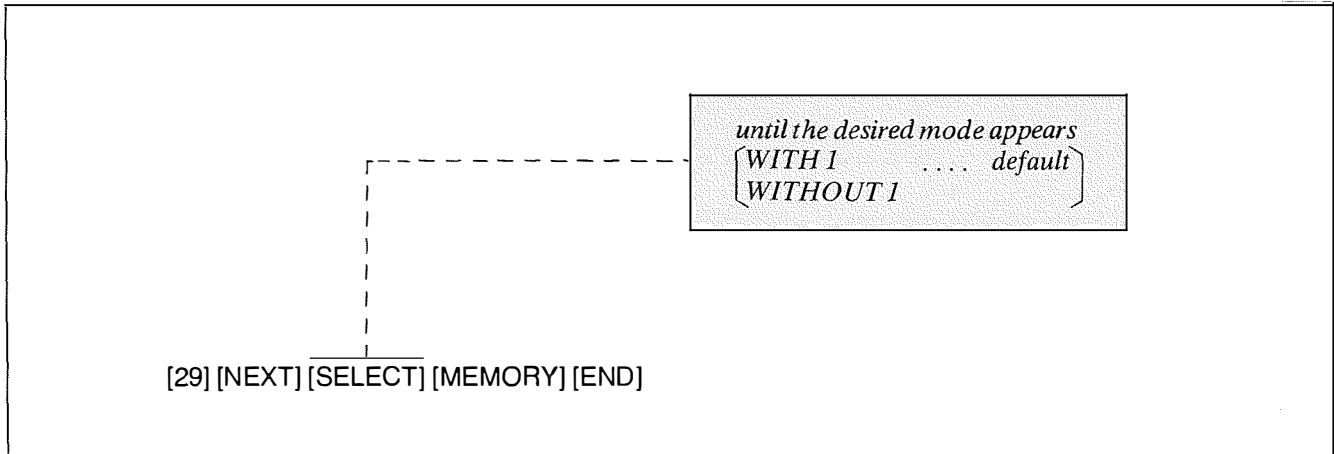

Description

Set to "WITH 1" for Toll Restriction in some area where it is need to dial 1 to toll call (long distance).

Example:

You are required to insert a dial "1" before dialing the area code for long distance call.

1-201-348-7000
 └─── area code

Set to "WITHOUT 1" in area where dial "1" is not need.

Programming

1. Dial (29).
"TOLL PREFIX" will be displayed.
2. Press the NEXT button.
"WITH 1" will be displayed and blink.
3. Press the SELECT button to alternate between "WITHOUT 1" and " WITH 1" to select the desired mode.
4. Press the MEMORY button.
The blinking LCD will stop.
5. To return to the initial program mode, press the END button.

Programming Table

See page 5-17.

Programmable Secret Auto Dial

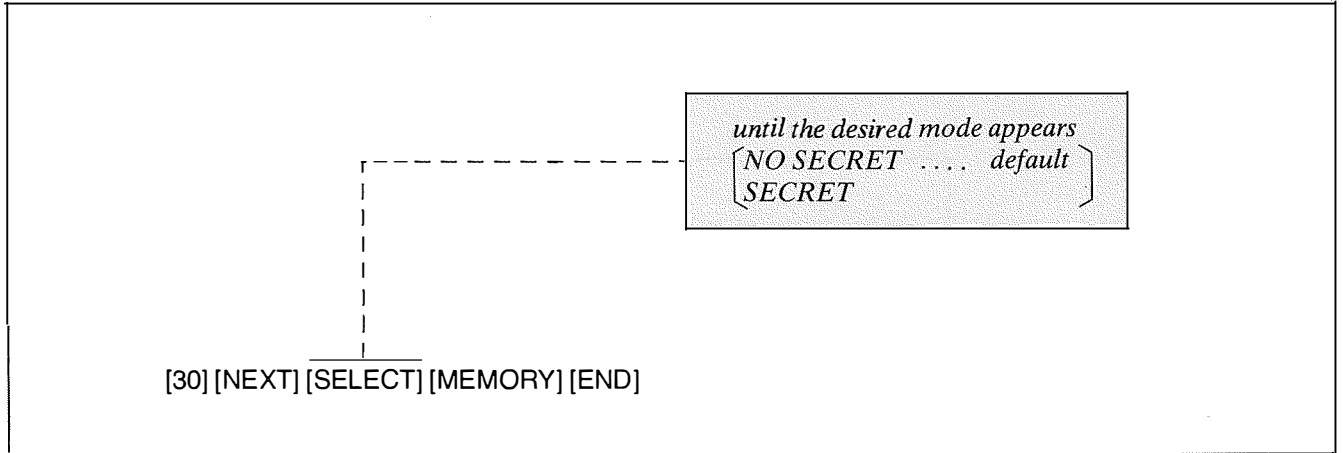

Description

When you dialed on outside line by speed dialing, the dialed number can be secret. The dialed number will not be displayed on the LCD of the KX-T30830.

Programming

1. Dial (30).
"SECRET AUTO DIAL" will be displayed.
2. Press NEXT button.
"NO SECRET" will be displayed and blink.
3. Press the SELECT button to alternate between "NO SECRET" and "SECRET" to select the desired mode.
4. Press the MEMORY button.
The blinking LCD will stop.
5. To return to the initial program mode press the END button.

Programming Table

See page 5-17.

DETAILED FEATURE DESCRIPTION AND OPERATION FOR EMSS PROPRIETARY TELEPHONE

To operate this system, after making program changes, set the System Program Switch located on the KX-T30810 (Electronic Modular Switching System) to the SET position.

To Make Calls

When the unit is unused, the Liquid Crystal Display will show the month, day and the present time.

Inter Office Calling (Intercom)

Using the Handset



LIFT THE
HANDSET

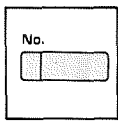

PRESS THE
DSS BUTTON
(11 through 18)

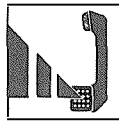

TALK



HANG UP

Hands-free

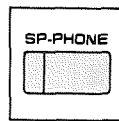

PRESS
"SP-PHONE"

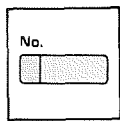

PRESS THE
DSS BUTTON
(11 through 18)



TALK

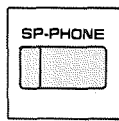

PRESS
"SP-PHONE"

- You may dial the extension number (11 through 18) instead of pressing the DSS button.
- You may press the ICM button instead of the first SP-PHONE button.
- DSS—Direct Station Selection (extension 11 through 18)
- ICM—Intercom

To Dial Another Extension Again without Hanging Up

While having a conversation;

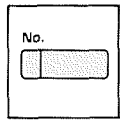

PRESS ANOTHER
DSS BUTTON

- The original conversation will be terminated and another extension can be dialed.

Description

Station to station dialing within the KX-T30810 system.

Operation

Using the handset

1. Lift the handset.
2. Press the DSS button.
3. Start talking
4. Hang up upon completion of the conversation.

Hands-free

1. Press the SP-PHONE or ICM button.
2. Press the DSS button.
3. Start talking
4. Press the SP-PHONE button.

- You may dial the extension number (11 through 18) instead of pressing the DSS button.

To dial another extension again without hanging up

While having a conversation;
press the DSS button.

- The original conversation will be terminated and another extension can be dialed.

Conditions

- When a called party has the KX-T30830 equipped with the LCD, an extension number of the calling party will be displayed on the LCD of the called party.
- An extension number of the calling party will be displayed on the LCD of the KX-T30830.
- You can not use the DSS button whose indicator has been already lighting since anyone is using the extension.
- The ICM indicator will be lit green while using the unit.

Outward Dialing

■ Automatic Line Access

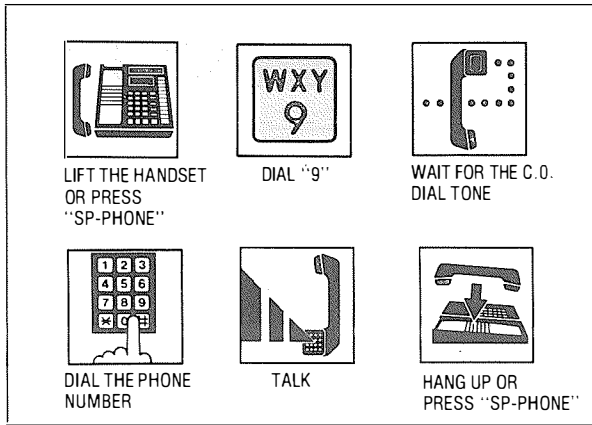

Description

Each extension can automatically select an idle CO (Central Office) Line within the KX-T30810.

Operation

1. Lift the handset or press the SP-PHONE button.
2. Dial (9).
Dial tone from CO (Central Office) will be heard.
3. Dial the phone number.
4. Start talking.
5. Hang up or press the SP-PHONE button upon completion of the conversation.

Conditions

- 9 dialed, will be displayed on the LCD of the KX-T30830 and you will hear followings.
- Dial tone from CO: indicates that the CO Line is captured.
- Busy tone: indicates that the three CO Lines are busy.
- Reorder tone: indicates that the extension is denied access outside line.
- The CO indicator will be lit green at your extension and lit red at other extensions.

■ Individual Line Access

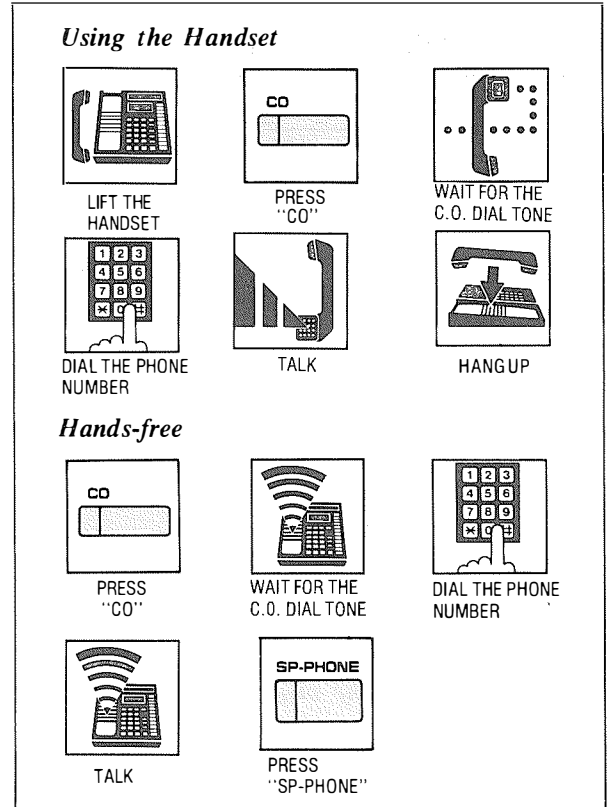

Description

Any of the 3 CO's may be directly selected.

Operation

Using the handset

1. Lift the handset.
2. Press the CO button.
Dial tone from CO will be heard.
3. Dial the phone number.
4. Start talking.
5. Hang up.

Hands-free

1. Press the CO button.
Dial tone from CO will be heard.
2. Dial the phone number.
3. Start talking.
4. Press the SP-PHONE button.

- The phone number dialed will be displayed on the LCD of the KX-T30830.
- You can not use the CO button whose indicator has been already lighting red since anyone is using the CO line.

Outward Dialing (cont.)

Individual Line Access

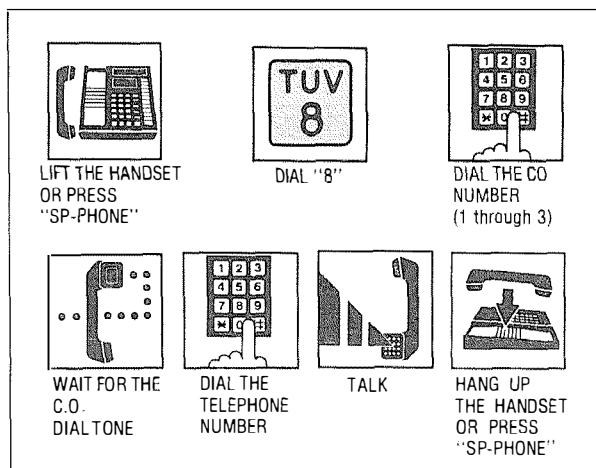

Description

Any of the 3 CO Lines may be selected by dial access.

Operation

1. Lift the handset or press the SP-PHONE button.
2. Dial (8) and the CO number (1 through 3). Dial tone from CO (Central Office) will be heard.
3. Dial the phone number.
4. Start talking.
5. Hang up or press the SP-PHONE button.

Conditions

- The phone number dialed will be displayed on the LCD of the KX-T30830.
- Individual line access codes
Dial 81 for CO 1
Dial 82 for CO 2
Dial 83 for CO 3

Each extension can access new CO line without hanging up.

While having a conversation,

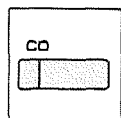

PRESS ANOTHER "CO"

- The original conversation will be terminated and new CO line can be accessed.

Speed Dialing

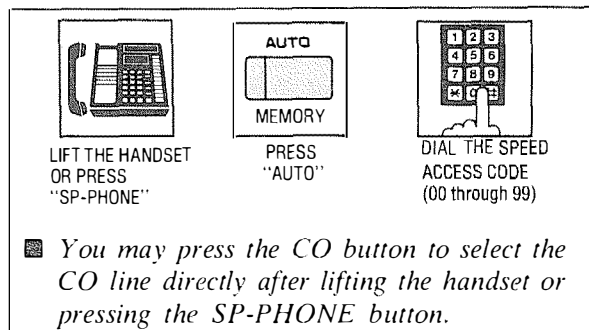

Description

There are 100 memory locations of system speed dialing available.

Operation

1. Lift the handset or press the SP-PHONE button.
2. Press the AUTO button.
3. Dial speed access code.
 - You may press the CO button to select the CO line directly after lifting the handset or pressing the SP-PHONE button.

Condition

- The dialed number will be displayed on the LCD of the KX-T30830.
- Continuous use of speed dial is possible.
ex. [AUTO] [0] [0] [AUTO] [0] [1]
- The combination of speed dialing, one touch dialing and manual dialing is possible.

One Touch Dialing

Programming

- Be sure the handset is in the cradle and the SP-PHONE button is OFF.
- Set the MEMORY switch of the KX-T30830, KX-T30820 or KX-T30850 to "PROGRAM".

■ Storage

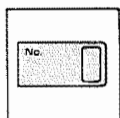

PRESS
"PROGRAMMABLE
FEATURE"



DIAL "9"

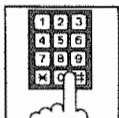

DIAL THE
PHONE
NUMBER

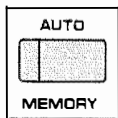

PRESS
"MEMORY"

- You may dial 81 through 83 instead of 9.
9 Each extension can automatically select an idle CO line.
81 through 83... Each extension can select a CO line designated.

9 or 81 through 83 must be dialed for storage.

■ To Correct an Error while Programming



PRESS
"CLEAR (TRANSFER)"
INSTEAD OF
"MEMORY"

- After pressing the CLEAR button, reprogram the correct number.

- The TRANSFER button is used as the CLEAR button.

■ To Change a Stored Number

Repeat "Storage" above.

■ To Erase after Programming

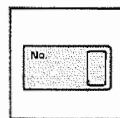

PRESS
"PROGRAMMABLE
FEATURE"

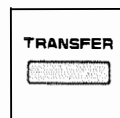

PRESS
"CLEAR
(TRANSFER)"

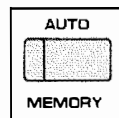

PRESS
"MEMORY"

- The TRANSFER button is used as the CLEAR button.

After programming all the numbers, return the MEMORY switch to "SET".

Dialing



LIFT THE HANDSET
OR PRESS
"SP-PHONE"

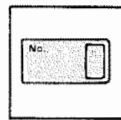

"PRESS
PROGRAMMABLE
FEATURE"

- You may press the CO button to select the CO line directly after lifting the handset or pressing the SP-PHONE button.

Description

There are 12 memory locations for automatic dialing available. Up to 32 digits can be stored into each of the 12 memory locations. Pushing the “*”, “#”, “-”, “FLASH” or “PAUSE” button counts as 1 digit.

• For your convenience, program private phone numbers into the KX-T30830, KX-T30820 or KX-T30850.

Programming

Be sure the handset is in the cradle and the SP-PHONE button is OFF.

1. Set the MEMORY switch to “PROGRAM”. “ONE TOUCH DIAL” will be displayed.
2. Press a programmable feature button.
The LCD will show “M01: NOT STORED” when nothing is stored in the programmable feature button “01”.
When automatic line access number 9 and the phone number 123-456-7890 has been stored, “M01: -123-456-7890” will be displayed.
3. Enter the line access number.
9: automatic line access number
81: line access number of CO 1
82: line access number of CO 2
83: line access number of CO 3
4. Enter the phone number.
• You may enter punctuations during a phone number.
The SNR button is used as the “-” button.
• To erase a wrong enter, press the CLEAR button.
The TRANSFER button is used as the CLEAR button.
5. Press the MEMORY button.
The MEMORY indicator will be lit.
6. Repeat steps 2 to 5, to program on other programmable feature button.
7. After programming all the numbers, return the MEMORY switch to the “SET” position.
The MEMORY indicator will go out.

Dialing

1. Lift the handset or press the SP-PHONE button.
2. Press a programmable feature button.
• You may press the CO button to select the CO line directly after lifting the handset or pressing the SP-PHONE button.

Conditions

- To more the 13 digits of a phone number, use the “↵”, or “↶” button for scrolling the display.
- The dialed phone number will be displayed on the LCD of the KX-T30830.
- Continuous use of the programmable feature button is possible. (ex. press 01-02)
- The combinations of speed dialing, one-touch dialing and manual dialing is possible.
- The line access number (9, 81, 82 or 83) should be stored.
- Continuous use of one touch dialing is possible.

Example:

[01] [02]

In this case, programmable feature button “02” should not include the line access number.

- When dialing, the pause is automatically entered after line access number (9, 81, 82 or 83).
- Features that can be accessed by using the dialing button also can be programmed into memory.
Refer to “One Touch Access for System Features” page 3-25.

Examples:

Automatic line access number 9 and phone number 123-4567 into the programmable feature “01” button.

Programming

[Set to “PROGRAM”] [01] [9]
[123-4567] [MEMORY] [Set to “SET”]

Dialing

[LIFT HANDSET] [01]

- You may press the CO button to select the CO line directly after lifting the handset.

Calling Doorphone

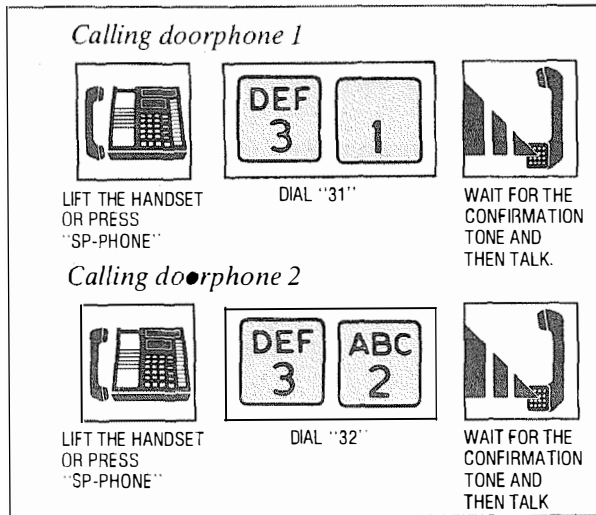

Description

Up to two doorphones (KX-T30865) can be connected to the KX-T30810.

Operation

Dialing to the doorphones

1. Lift the handset or press the SP-PHONE button.
2. Dial (31) for calling doorphone 1. Dial (32) for calling doorphone 2. "DOOR 1" or "DOOR 2" will be displayed.
3. Wait for the confirmation tone and then start talking.
4. Hang up or press the SP-PHONE button upon completion of the conversation.

Conditions

- The features, for instance, hold, transfer and so on, can not be activated by the doorphone.

Distinctive Dial Tone

Description

A distinctive dial tone will be heard from the handset if the extension user has previously activated a special feature.

Operation

None

Conditions

There are two types of dial tones.
Dial tone 1: ordinary dial tone

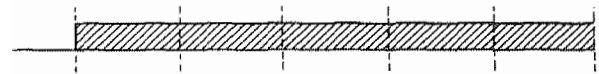

Dial tone 2: when any of the following features is activated:

Do not Disturb.
Dial Call Pickup Deny
Call Forwarding.
Data Line Security.

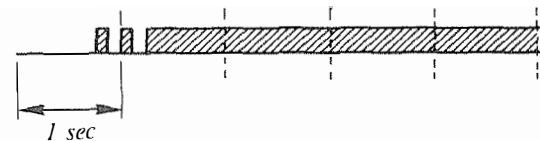

When a Line is Busy

Automatic Call Back Busy— (Camp-on)

Setting

For outside (trunk) calls

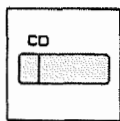

PRESS
"CO"



YOU WILL
HEAR A BUSY
TONE



DIAL "6"



CONFIRMATION
TONE OF 2 BEEPS
WILL BE HEARD



HANG UP OR
PRESS
"SP-PHONE"

When hearing a recall for camp-on
When outside calls



LIFT THE HANDSET
OR PRESS
"SP-PHONE"

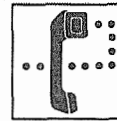

YOU WILL
HEAR THE CO
DIAL TONE

For intercom calls

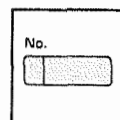

PRESS THE
DSS BUTTON



YOU WILL
HEAR A BUSY
TONE

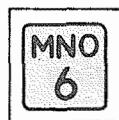

DIAL "6"



CONFIRMATION
TONE OF 2 BEEPS
WILL BE HEARD



HANG UP OR
PRESS
"SP-PHONE"

When intercom calls

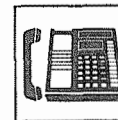

LIFT THE HANDSET
OR PRESS
"SP-PHONE"

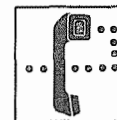

YOU WILL HEAR THE
RING BACK TONE

Description

If the intercom extension or outside line you have dialed is busy, you will be automatically called back when the extension or the outside line becomes free using this function. This feature is also known as camp-on.

Operation

Setting

1. Lift the handset or press the SP-PHONE button.
2. For intercom calls, press the DSS button or dial the extension number.
For outside calls, press the CO button.
3. Dial (6) after a busy tone is heard.
4. Wait for the confirmation tone.
"CAMP ON CO" or "CAMP ON EXT" will be displayed.
5. Hang up or press the SP-PHONE button.

When hearing a recall for camp-on;

Lift the handset or press the SP-PHONE button.

- When intercom calls, you will hear the ring back tone.
- When outside calls, you will hear the CO dial tone.

Conditions

- Lifting the handset (or pressing the SP-PHONE button) during the camp-on mode will cause the camp-on feature to be cancelled.
- An extension may be the recipient of more than one call back busy, the call backs will be executed in the order of their arrival.
- If a call back is not answered at the originating extension within 10 seconds, the call back will be cancelled.

Recall for camp-on

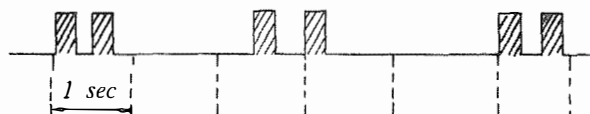

Busy Station Signaling

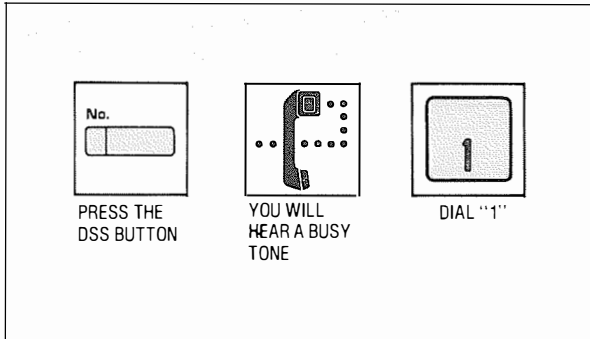

Description

If the extension you have dialed is busy, you can inform that extension that another intercom call is reaching by three beeps.

For use of this feature, the other extension is required to be set this feature beforehand in the KX-T30810.

Operation

1. Lift the handset or press the SP-PHONE button.
2. Press the DSS button or dial the extension number.
3. When you will hear a busy tone, dial (1).

Conditions

- To answer your signal, see "Call Waiting" on page 3-18.
- While the other party is using a data equipment, you may not be able to use this feature.
- If a busy tone is heard after dialing 1, it indicates that the other party has not set this feature.

Last Number Redial

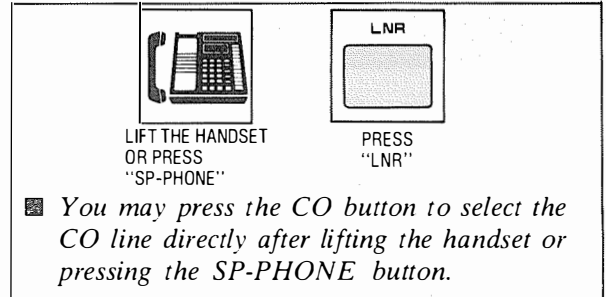

- You may press the CO button to select the CO line directly after lifting the handset or pressing the SP-PHONE button.

Description

The last phone number dialed on an outgoing call to CO line can be redialed.

Operation

1. Lift the handset or press the SP-PHONE button.
2. Press the LNR button.

- You may press the CO button to select the CO line directly after lifting the handset or pressing the SP-PHONE button.

Conditions

- Up to 32 digits can be stored and redialed. Pushing the "*" "#" or "PAUSE" button counts as 1 digit.
- When calling or while in the conversation mode, pressing the LNR button will cause the redial to operate after about 3 seconds.

To Receive Calls

Answer

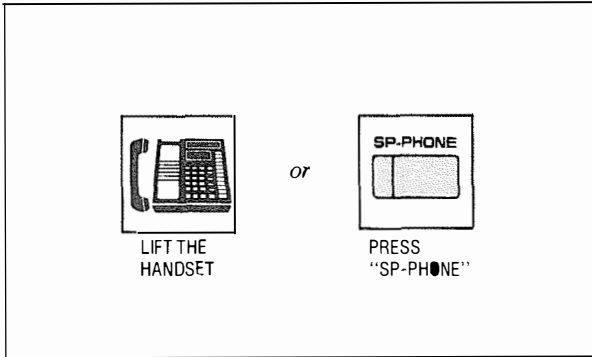

Automatic Answer-Intercom

Setting

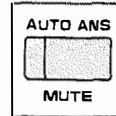

PRESS "AUTO ANS"
(INDICATOR WILL
BE LIT)

To cancel

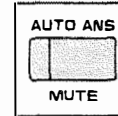

PRESS "AUTO ANS"
(INDICATOR WILL
GO OUT)

Operation

Lift the handset or press the SP-PHONE button.

- When "Automatic Answering Selection" feature is selected "manual" mode in the KX-T30810 and outside call reaches, lift the handset and then press the CO button whose indicator is flashing red.
- When an intercom call reaches, you may press the ICM button whose indicator is flashing quickly and talk. (Hands-free mode)
- When an outside call reaches, you may press the CO button whose indicator is flashing red quickly and talk. (Hands-free mode)

Description

Allows extension user to answer an intercom call in the automatic hands-free mode without any operation when receiving intercom calls.

Operation

1. For setting, press the AUTO ANS button. The AUTO ANS indicator will be lit.
2. For cancellation, press the AUTO ANS button again. The AUTO ANS indicator will go out.

Description

- This feature is required to be set beforehand while the unit is not in use.

Dial Call Pickup

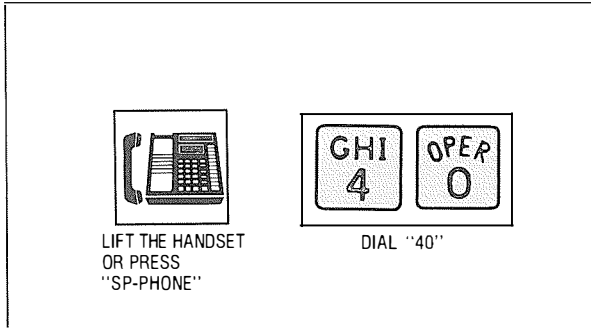

Description

An extension user can answer any ringing extension within their own pickup group.

Operation

1. Lift the handset or press the SP-PHONE button.
2. Dial (40) and wait for confirmation tone.
3. Start talking.

Conditions

- Dial Call Pickup will work for incoming calls (intercom, outside and doorphone) but will not work for camp-on recalls and hold recalls.
- If a ringing extension is outside pickup group or is in the mode of dial call pickup denied, a reorder tone will be heard through the use of this feature.
- Refer to "Dial Call Pickup Group Assignment" on page 2-31.
- Dial Call Pickup can use with the present call placed on hold.

Directed Call Pickup

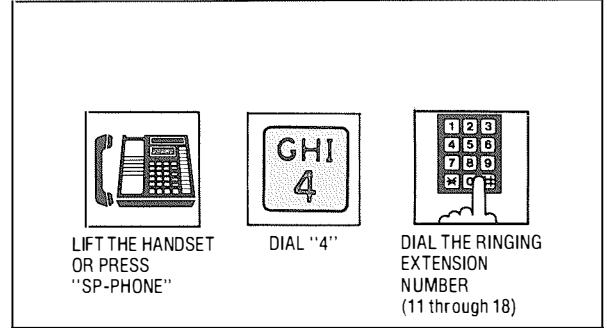

Description

An extension may answer an incoming call that is ringing at another extension regardless of pickup group.

Operation

1. Lift the handset or press the SP-PHONE button.
2. Dial (4) and then the extension number (11 through 18) at which call is ringing.
3. Wait for confirmation tone and then start talking.

Conditions

- It is possible to answer calls outside your assigned pickup group.
- Directed Call Pickup can use with the present call placed on hold.

Example:

Mr Brown's extension number is 16.
He is now out of office.

Mark receives the call instead of Mr. Brown with the telephone on his desk, extension 15.



Call Park Retrieve

To retrieve a parked call at any extension



LIFT THE
HANDSET
OR PRESS
"SP-PHONE"

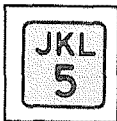

DIAL "5"

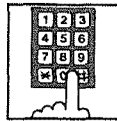

DIAL PARKED
EXTENSION
NUMBER

Description

Allows extension user to retrieve a call (intercom or outside) on hold at any extension.

Operation

When an intercom or outside call is on hold.

1. Lift the handset or press the SP-PHONE button at any extension.
2. Dial (5) and the extension number of the phone on which the call is placed on hold. Connection is now made with the party who was on hold.
3. Wait for confirmation tone and then start talking.

Conditions

- Call park retrieving is possible regardless of the handset position on the phone which has placed the call on hold.
- If the extension that you want to retrieve the call park has several calls on hold, only the last call on hold is retrieved.

Example:

Mark is talking with extension 15 on his desk, and then moves to another room keeping the call on hold.

He resumes the conversation using another extension.

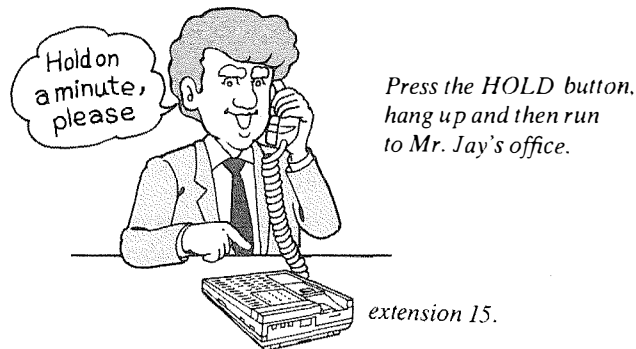

Dial **5** and the extension number **15** at Mr. Jay's office.

Doorphone

To answer a doorphone



LIFT THE
HANDSET

or



PRESS
"SP-PHONE"

Operation

Lift the handset or press the SP-PHONE button.

Conditions

- If calls from doorphones are not answered within 15 seconds, the calls will be cancelled.
- Ring from doorphone.

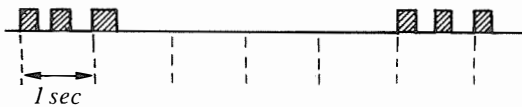

- Each extension has to be programmed for receiving from doorphones. See "Programmable Doorphone" on page 2-30.

Distinctive Ring Tone

Description

A different ringing pattern is used to distinguish intercom calls from incoming outside calls.

Operation

None

Conditions

Automatic ring back for the camp on feature will ring differently from the ringing on intercom, outside, doorphone calls.

Incoming outside calls (including outside hold recall)

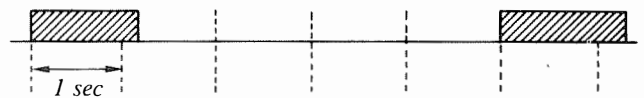

Intercom calls (including intercom hold recall)

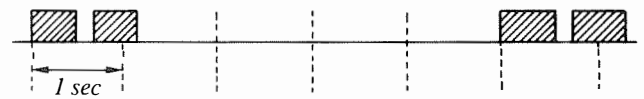

Doorphone calls

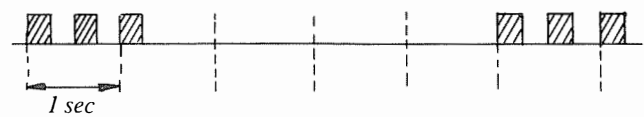

While Having a Conversation

Call on Hold—CO

To place a call on hold:

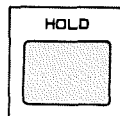

PRESS
"HOLD"

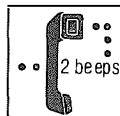

CONFIRMATION
TONE OF 2
BEEPS WILL
BE HEARD

To retrieve:

• at the holding extension

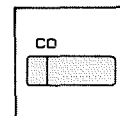

PRESS "CO"

(flashing
in green)

• from another extension

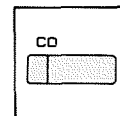

PRESS "CO"

(flashing
in red)

Description

If you wish to leave your phone unattended but want the caller you are in conversation with to wait, call hold may be used. Outside calls may be placed on hold.

Calls on hold can be released by another extensions.

Operation

1. You are in conversation with an outside party.

2. Press the HOLD button.

The indicator of CO button which is on hold will flash slowly (green color).

The confirmation tone of 2 beeps will be heard.

To Retrieve at the holding extension,
press the CO button (flashing green).

The indicator light will return to a steady green.

To Retrieve from another extension,

■ press the CO button (flashing red).

or

■ dial (5) and then the extension number of the phone on which the call was placed on hold.

[5] [AB]

—AB=11 through 18

- The green flashing indicator at the held extension will turn red.
- Refer to "Call Park Retrieve" on page 3-11.

Conditions

• When a call is on hold for more than 30 minutes after a hold time reminder is sounded the call will be terminated automatically.

A hold time reminder is sounded through the built-in speaker of the extension.

• Calls on hold will be recalled either after 30 seconds, 1 minute, 1 minute and 30 seconds or 2 minutes, once handset is replaced (or the SP-PHONE button is pressed).

If hold recall time set is set to "DISABLE", will not be recalled.

Refer to "Hold Recall Time Set" on page 2-34.

• The hold time reminder is activated, even if the hold recall time set is programmed to "DISABLE".

• When lifting the handset (or by pressing the SP-PHONE button):

before recalling... The dial tone will be heard with the call on hold.

You may dial another phone number.

while recalling... Only the first call on hold will be released and entered into the conversation mode.

Call on Exclusive Hold—CO

To place a call
on exclusive hold:

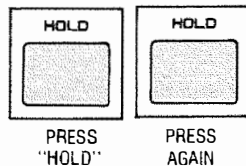

To retrieve:

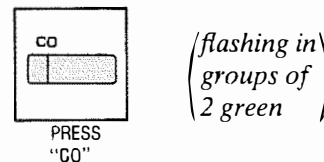

Description

The calls on exclusive hold can not be released by any extension other than the phone which has placed the call on hold.

Operation

1. You are in conversation with an outside party.
2. Press the **HOLD** button.
The indicator of the **CO** button which is on hold will flash slowly (green color).
The confirmation tone of 2 beeps will be heard.
3. Press the **HOLD** button again.
The indicator will flash in groups of 2 (green color).
4. To retrieve, press the **CO** button whose indicator flashing in groups of 2 (green color).
 - The indicator flashing in groups of 2 will turn on.

Conditions

- When a call is on hold for more than 30 minutes after a hold time reminder is sounded the call will be terminated automatically.
A hold time reminder is sounded through the built-in speaker of the extension.
- Calls on hold will be recalled either after 30 seconds, 1 minute, 1 minute and 30 seconds or 2 minutes, once handset is replaced (or the **SP-PHONE** button is pressed).
If hold recall time set is set to "DISABLE", will not be recalled.
Refer to "Hold Recall Time Set" on page 2-34.
- The hold time reminder is activated, even if the hold recall time set is programmed to "DISABLE".
- When lifting the handset (or by pressing the **SP-PHONE** button):
 - before recalling...the dial tone will be heard with the call on hold.
You may dial another phone number.
 - while recalling.. Only the first call on hold will be released and entered into the conversation mode.

Call on Hold—Intercom

To place a call on hold:

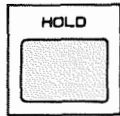

PRESS
"HOLD"



CONFIRMATION
TONE OF 2
BEEPS WILL
BE HEARD

To retrieve:

• at the holding extension

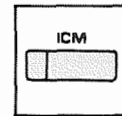

PRESS
"ICM"

(flashing)

• from another extension

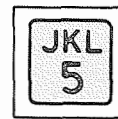

DIAL "5"

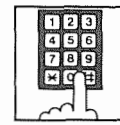

DIAL THE HOLDING
EXTENSION
NUMBER

Description

Extension user can place an intercom call on hold.

Calls on hold can be released by another extensions.

Operation

1. You are in conversation with an internal party.

2. Press the HOLD button.

The indicator on the ICM button will flash slowly.

The confirmation tone of 2 beeps will be heard.

To retrieve at the holding extension,

press the ICM button whose indicator flashing slowly.

The indicator on the ICM button will be on.

To retrieve from another extension,

dial (5) and then the extension number of the phone on which the call was placed on hold.

[5] [AB]

-----AB=11 through 18

• Refer to "Call Park Retrieve" on page 3-11.

• When a call is on hold for more than 30 minutes after a hold time reminder is sounded, the call will be terminated automatically.

A hold time reminder is sounded through the built-in speaker of the extension.

• Calls on hold will be recalled either after 30 seconds, 1 minute, 1 minute and 30 seconds or 2 minutes, once handset is replaced (or the SP-PHONE button is pressed).

If hold recall time set is set to "DISABLE", will not be recalled.

Refer to "Hold Recall Time Set" on page 2-34.

• The hold time reminder is activated, even if the hold recall time set is programmed to "DISABLE".

• When lifting the handset (or by pressing the SP-PHONE button):

before recalling...the dial tone will be heard with the call on hold.

You may dial another phone number.

while recalling...the call on hold will be released and entered into the conversation mode.

• An Intercom hold can be activated on one extension only.

Call on Exclusive Hold—Intercom

To place a call
on exclusive hold:

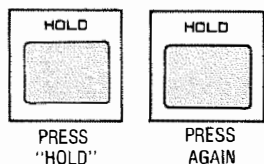

To retrieve

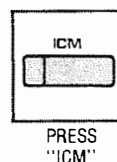

Description

The intercom call on exclusive hold can not be released by any extension other than the phone which has placed the call on hold.

Operation

1. You are in conversation with an internal party.
2. Press the **HOLD** button.
The indicator on the **ICM** button will flash slowly.
The confirmation tone of 2 beeps will be heard.
3. Press the **HOLD** button, again.
The indicator will flash in groups of 2.
4. To retrieve, press the **ICM** button.
The indicator on the **ICM** button will return to a steady green.

Conditions

- When a call is on hold for more than 30 minutes after a hold time reminder sounds, the call will be terminated automatically. A hold time reminder is sounded through the built-in speaker of the extension.
 - Calls on hold will be recalled either after 30 seconds, 1 minute, 1 minute and 30 seconds or 2 minutes, once handset is replaced (or the **SP-PHONE** button is pressed). If hold recall time set is set to “**DISABLE**”, will not be recalled. Refer to “**Hold Recall Time Set**” on page 2-34.
 - The hold time reminder is activated, even if the hold recall time set is programmed to “**DISABLE**”.
 - When lifting the handset (or by pressing the **SP-PHONE** button):
 - before recalling...the dial tone will be heard with the call on hold.
You may dial another phone number.
 - while recalling...the call on hold will be released and entered into the conversation mode.
- An Intercom hold can be activated on one extension only.

Conference

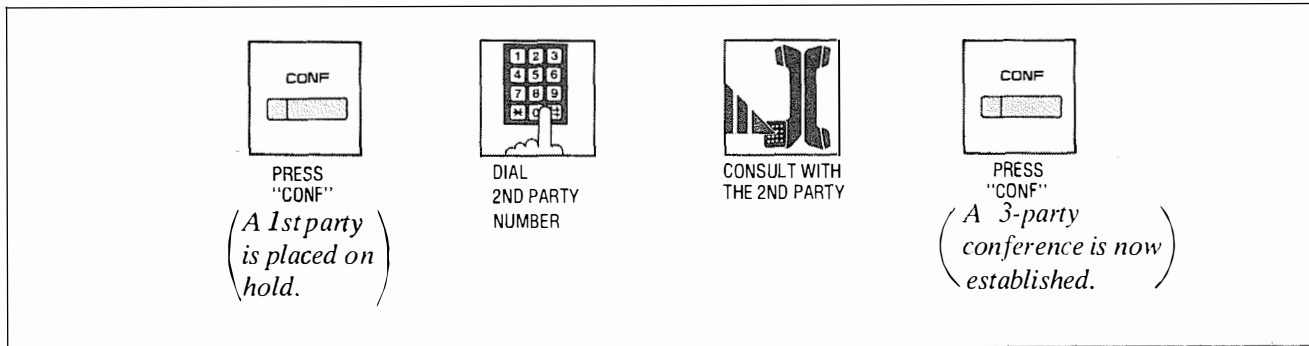

Description

Allows for up to a three party conference, (2-outside/1-inside) (1-outside/2-inside) or (3-inside).

Operation

1. Press the CONF button, to place the first party on hold.
2. Dial the number of the second party.
If second party does not answer, press the CO button of the outside party concerned, or the ICM button to return to the first party.
3. Press the CONF button.
The confirmation tone will be heard.
3 party conference is now established.
"CONF" will be displayed.

- You may press the HOLD button instead of the first CONF button.

To terminate conference

Replace the handset or press the SP-PHONE button.

- The other two parties are directly connected together and can converse with each other. (Intercom calls and intercom to outside are OK, outside to outside is not possible.)

To terminate one caller and talk to the another caller.

- If both the conference parties are on the outside:
Press the CO button to talk to the desired party.

- If both the conference parties are on the extension:
Press the ICM button.
You will be connected to the first participant.

- If the conference parties are on the outside and extension:
To talk to the outside party, press the CO button.
To talk to the extension party, press the ICM button.

To leave the other two parties on hold at the same time.

Press the HOLD button.

- In case the other two parties are on the extension, the other two parties can not be left on hold.

Conditions

- Pressing a CO button which is out of conference, allows you to exit from the conference and to access an outside party and the other parties to be connected together.

If the other parties are outside ones, they are disconnected.

If the other parties are on the outside and extension, they are connected.

- Pressing the ICM button for conference, allows you to exit from the conference and to access an intercom.

Call Waiting

To terminate the original call and talk to the new caller.



WILL HEAR A CALL WAITING TONE

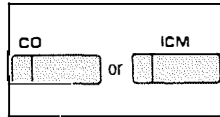

PRESS "CO" OR "ICM" WHOSE INDICATOR IS FLASHING QUICKLY (The original call is now terminated.)



TALK

To place the original call on hold and talk to the new caller.

• If both original call and new call are intercom calls:

(The ICM indicator will change lighting into flashing quickly when new call reaches.)

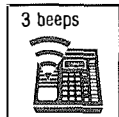

WILL HEAR A CALL WAITING TONE

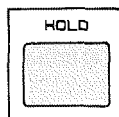

PRESS "HOLD" (The dial tone is not heard.)



CONSULT WITH THE NEW CALLER WHILE THE ORIGINAL CALL IS ON HOLD

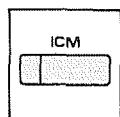

PRESS "ICM" TO TERMINATE THE 2ND CALL AND TO RETURN TO THE ORIGINAL CALL

• If original call is CO call, and new call is CO call or intercom call:

or

If original call is intercom call and new call is CO call:

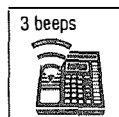

WILL HEAR A CALL WAITING TONE

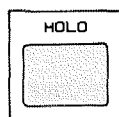

PRESS "HOLD" (The dial tone is heard.)

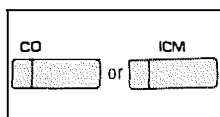

PRESS "CO" OR "ICM" WHOSE INDICATOR IS FLASHING QUICKLY



CONSULT WITH THE NEW CALLER WHILE THE ORIGINAL CALL IS ON HOLD

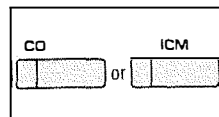

PRESS "CO" OR "ICM" TO TERMINATE THE 2ND CALL AND TO RETURN TO THE ORIGINAL CALL

Description

Call waiting tone during a conversation indicates there is a new incoming CO line call or Intercom call.

This feature is required to be set beforehand in the KX-T30810.

For programming, see page 2-24.

Operation

To terminate the original call and talk to the new caller.

1. You will hear a call waiting tone (3 beeps).
2. Press the CO or ICM button whose indicator is flashing quickly. The original call is now terminated.
3. Start talking.

To place the original call on hold and talk to the new caller.

If both original call and new call are intercom calls:

(The ICM indicator will change lighting into flashing quickly when new call reaches.)

1. You will hear a call waiting tone (3 beeps).
2. Press the HOLD button for placing a conversation on hold.
3. Consult with the new caller.
4. Press the ICM button to terminate the second call and to return to the original call.

If original call is CO call, and new call is CO call or intercom call:

or

If original call is intercom call and new call is CO call:

1. You will hear a call waiting tone.
2. Press the HOLD button for placing a conversation on hold.
3. Press the CO or ICM button whose indicator is flashing quickly.
4. Consult with the new caller.
5. Press the CO or ICM button to terminate the second call and to return to the original call.

Conditions

call waiting tone

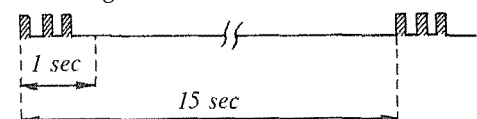

• If a call waiting tone is heard and the CO or ICM indicator does not flash, this tone indicates a call waiting tone by special company service.

In this case, see "Call Waiting-Outside Line" on page 3-26.

Call Transfer

To transfer after other extension answers

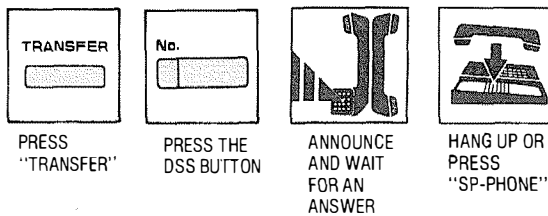

To transfer without announcing the other extension

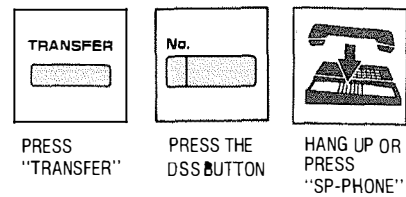

• You may dial the extension number instead of pressing the DSS button.

To Retrieve the Call

If the other extension did not receive the transferred call within 30 seconds after the call has been transferred, the call will return to you. In this case:

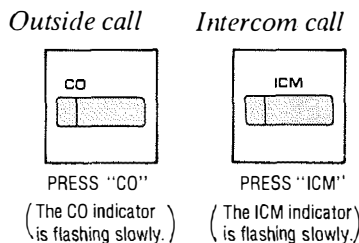

Description

Outside or intercom calls may be transferred to any extension manually.

Operation

1. You are engaged in a call (outside or intercom).
2. Press the **TRANSFER** button.
3. Press the **DSS** button corresponding to the destination.
or
Dial number of extension (11 through 18) to which the call is transferred.
4. For **Unscreened** call transfer, replace the handset or press the **SP-PHONE** button.
For **Screened** call transfer, wait for new party to answer and announce call, then replace the handset or press the **SP-PHONE** button.

To retrieve the Call

If the other extension did not receive the transferred call within 30 seconds after the call has been transferred, the call will return to you. In this case:
Press the **CO** or **ICM** button whose indicator is flashing slowly.

To change the party to whom a call is transferred before hanging up

Press the **CO** or **ICM** button whose indicator is flashing slowly to retrieve the call, then repeat the procedure of Call Transfer.

Conditions

- If the transferred call is not answered in a pre-determined time (see **Hold Recall Time Set**), it will cease to ring at the transferred extension and will recall back to the original transferring extension.
- Upon recall to the transferring extension, if call is not answered in 30 minutes it will be terminated.
- When busy, you may access the other extension by dialing 1.
Also you may return to the calling party by pressing the **CO** or **ICM** button whose indicator is flashing slowly (green color).

Call Splitting—Between CO and Intercom

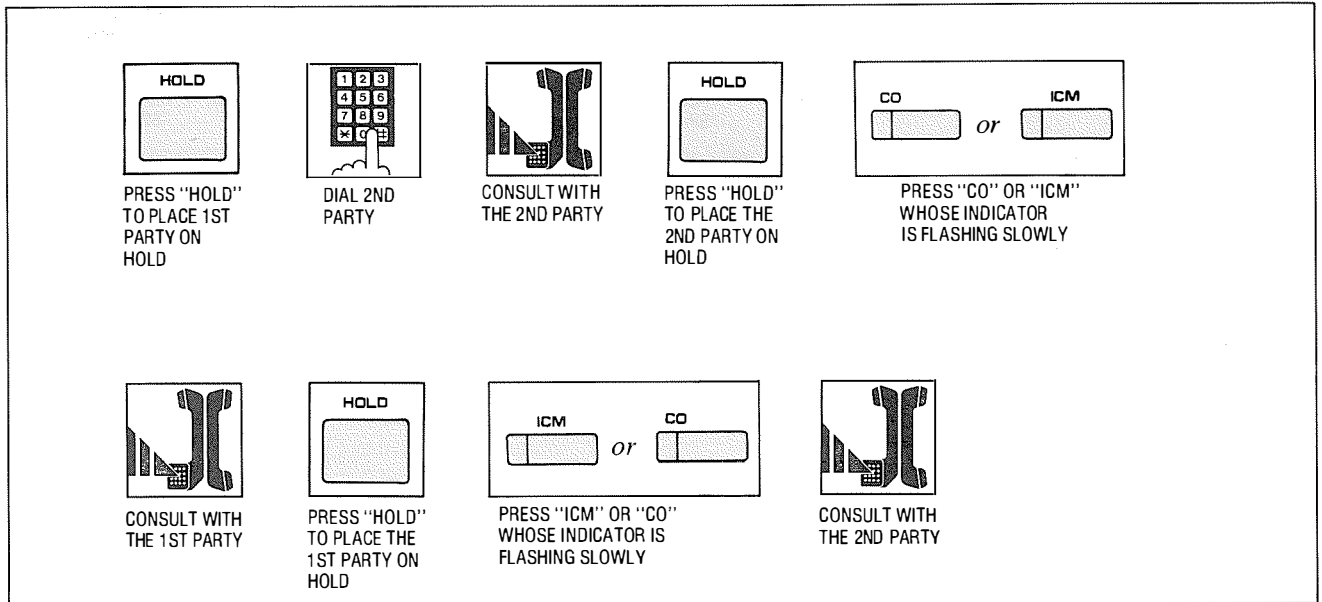

Description

Allows an extension user to alternate between a CO party and an Intercom party.

Operation

1. Press the *HOLD* button to place the first party on hold.
2. Dial the second party.
3. Consult with the second party.
4. Press the *HOLD* button to place the second party on hold.
5. Press the *CO* or *ICM* button whose indicator is flashing slowly.
6. Consult with the first party.
7. Press the *HOLD* button to place the first party on hold.

8. Press the *ICM* or *CO* button whose indicator is flashing slowly.

9. Consult with the second party.

10. Repeat step 4 to 9.

Conditions

- To release the call splitting mode, press the *CO* or *ICM* button without pressing the *HOLD* button. Conversation will be terminated and call on hold will be returned to conversation.

Call Splitting—Intercom

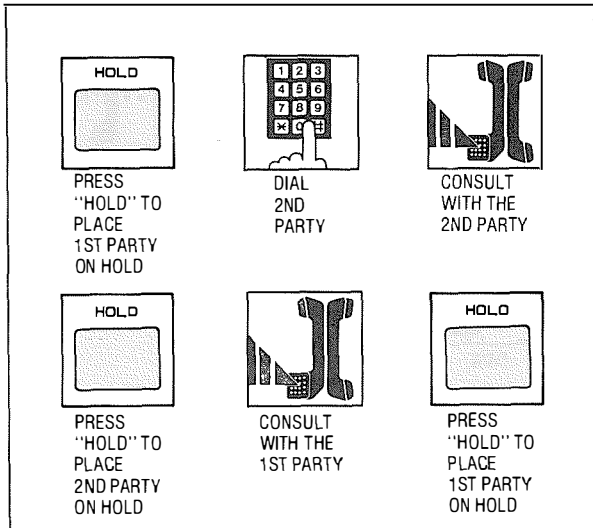

Description

Allows an extension user to alternate between two intercom parties.

Operation

1. Press the HOLD button to place the first party on hold.
2. Dial the second party.
3. Consult with the second party.
4. Press the HOLD button to place the second party on hold.
5. Consult with the first party.
6. Press the HOLD button to place the first party on hold.
7. Repeat step 3 to 6.

Conditions

- To release the call splitting mode, press the ICM button instead of the HOLD button. Conversation will be terminated and call on hold will be returned to conversation.

Paging

Paging All Extensions

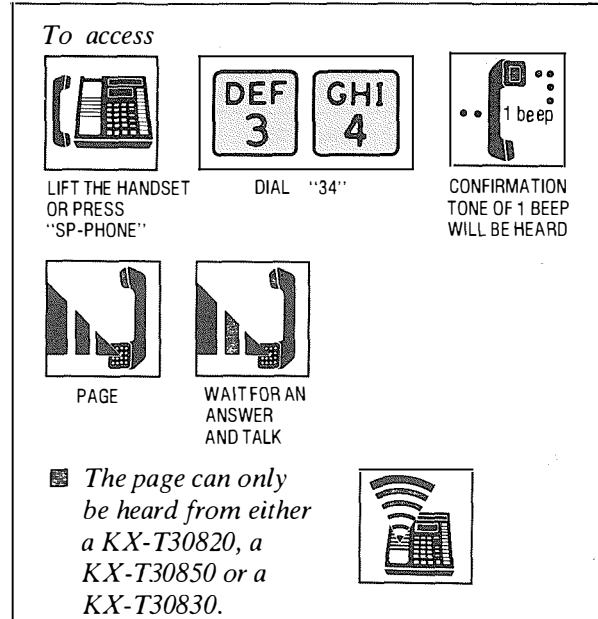

Description

Allows paging to all extensions.

Operation

To access paging;

1. Lift the handset or press the SP-PHONE button.
2. Dial (34) and wait for confirmation tone (one beep).
"PAGING (ALL)" will be displayed.
3. Start paging.
4. Wait for an answer and talk.

Conditions

- When an extension is in use, that extension cannot gain access to paging.
- When any extension is using the paging (all extensions, group or external), you cannot access to paging.

Paging Group

To access

For pickup group 1



LIFT THE HANDSET
OR PRESS
"SP-PHONE"

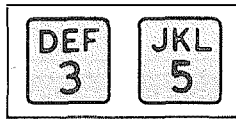

DIAL "35"

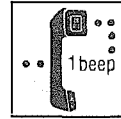

CONFIRMATION
TONE

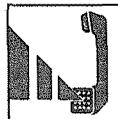

PAGE

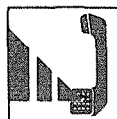

WAIT FOR AN
ANSWER
AND TALK

For pickup group 2:

At step 2 above, dial 36 instead of 35.

- The page can only be heard from either a KX-T30820, a KX-T30850 or a KX-T30830.



Paging—External

To access

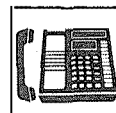

LIFT THE HANDSET
OR PRESS
"SP-PHONE"

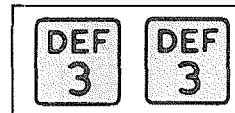

DIAL "33"

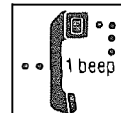

CONFIRMATION
TONE

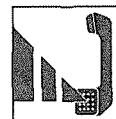

PAGE



WAIT FOR CONFIRMATION
TONE AND TALK

- Page will be heard from external paging equipment.



Description

Allows paging to either one of two groups.

Operation

To access paging;

1. Lift the handset or press the SP-PHONE button.
2. Dial (35) for paging the pickup group 1.
Dial (36) for paging the pickup group 2.
 - The confirmation tone (one beep) will be heard.
 - "PAGING (GRP 1)" or "PAGING (GRP 2)" will be displayed.
3. Start paging.
4. Wait for an answer and talk.

Conditions

- When an extension is in use, that extension cannot gain access to paging.
- Refer to "Dial Call Pickup Group Assignment" on page 2-31.

Description

Allows access to external paging equipment.

Operation

To access external paging;

1. Lift the handset or press the SP-PHONE button.
2. Dial (33) and wait for confirmation tone (one beep).
"EXTERNAL PAGING" will be displayed.
3. Start paging.
When the page is answered, one beep will be heard. Start talking.

Conditions

- If external paging access tone is set to "DISABLE", confirmation tone will not be heard after accessing the external paging.

Refer to "Programmable External Paging Access Tone" on page 2-35.

Paging And Transfer

To transfer a call to the paged person

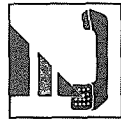

WHILE HAVING
A CONVERSATION

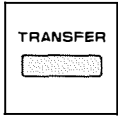

PRESS
"TRANSFER"

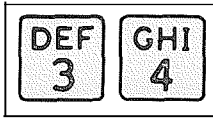

DIAL "34"

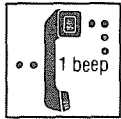

CONFIRMATION
TONE

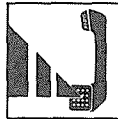

PAGE

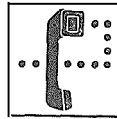

WAIT FOR AN
ANSWER



HANG UP OR
PRESS
"SP-PHONE"

• You may dial 35, 36 or 33 instead of 34.

Operation

To transfer a call to the paged person;

1. You are in conversation.
2. Press the **TRANSFER** button.
3. Dial (34) for paging all extensions.
Dial (35) for paging group 1.
Dial (36) for paging group 2.
Dial (33) for paging-external.
• Wait for confirmation tone.
4. Start paging.
5. Wait for an answer.
6. Hang up or press the **SP-PHONE** button.

Paging—Answer

To answer



LIFT THE HANDSET
OR PRESS
"SP-PHONE"

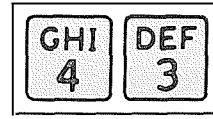

DIAL "43"

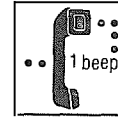

CONFIRMATION
TONE

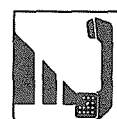

TALK

Description

A page from built-in speaker or external paging equipment can be answered from any extension.

Operation

To answer paging;

1. Lift the handset or press the **SP-PHONE** button.
2. Dial (43) and wait for confirmation tone (one beep).
3. Start talking.

Conditions

• If a call and CO number has been paged and transferred, you may answer by dialing 5 and pressing the **CO** button whose number has been paged and indicator is flashing slowly (red color), instead of dialing 43.

Use of Other Features

Background Music

To enable



LIFT THE HANDSET
OR PRESS
"SP-PHONE"

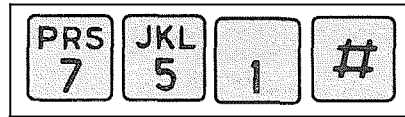

DIAL "751#"



REPLACE THE
HANDSET
OR PRESS
"SP-PHONE"



WILL HEAR
MUSIC

To cancel



LIFT THE HANDSET
OR PRESS
"SP-PHONE"

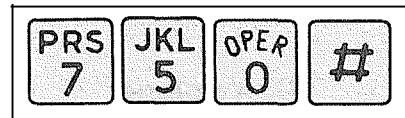

DIAL "750#"



REPLACE THE
HANDSET
OR PRESS
"SP-PHONE"

Description

Music from an external source (e.g. radio) can be listened to on the built-in speaker of the telephone.

Operation

To enable

1. Lift the handset or press the SP-PHONE button.
2. Dial (751#).
Wait for confirmation tone.
"BGM ON" will be displayed.
3. Replace handset or press the SP-PHONE button.
Music will be heard from the speaker.

To cancel

1. Lift the handset or press the SP-PHONE button.
2. Dial (750#).
Wait for confirmation tone.
"BGM OFF" will be displayed.
3. Place the handset back on the cradle or press the SP-PHONE button.
Music will be stopped.

Conditions

- When listening to the background music, the music will be interrupted by incoming calls, lifting handset or pressing the SP-PHONE button. After completion of the conversation replacing the handset back on the cradle or by pressing of the SP-PHONE button, will resume the background music.

Mute Operation

To enable

Be sure the SP-PHONE indicator is on.



PRESS
"MUTE"

- The MUTE indicator will flash.

To cancel

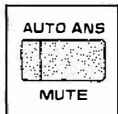

PRESS
AGAIN

Description

Use when you do not want your voice to be heard by the other party.

Operation

To enable

Be sure the SP-PHONE indicator is on.
Press the MUTE button.

- The MUTE indicator will flash.

To cancel

Press the MUTE button again.

- The MUTE indicator will go out.

Conditions

- This feature can be activated in speakerphone mode only.

One Touch Access for System Features

To Program

Set the MEMORY switch of the KX-T30830, KX-T30820 or KX-T30850 to "PROGRAM".

GRAM".

Example:

Paging All Extensions (Dial 34).

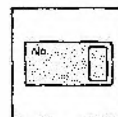

PRESS
"PROGRAMMABLE
FEATURE"

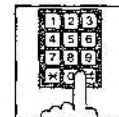

DIAL "34"

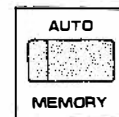

PRESS
"MEMORY"

After programming all the system features, return the MEMORY switch to "SET".

To Access

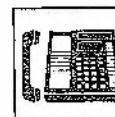

LIFT THE HANDSET
OR PRESS
"SP-PHONE"

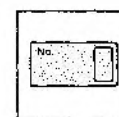

PRESS
"PROGRAMMABLE
FEATURE"

Description

Features that can be accessed by using the dialing button also can be programmed into memory.

(e.g. Paging All Extensions, Background Music.)

Operation

To Program

Set the MEMORY switch of the KX-T30830, KX-T30820 or KX-T30850 to "PROGRAM".

Example:

Paging All Extensions (Dial 34)

1. Press the PROGRAMMABLE FEATURE button.
2. Dial (34).
3. Press the MEMORY button.

- System feature described in the table on page 5-5 can be programmed into memory.

After programming all the numbers, return the MEMORY switch to "SET".

To Access

1. Lift the handset or press the "SP-PHONE" button.
2. Press the PROGRAMMABLE FEATURE button.

External Feature Access

Call Waiting—Outside Line

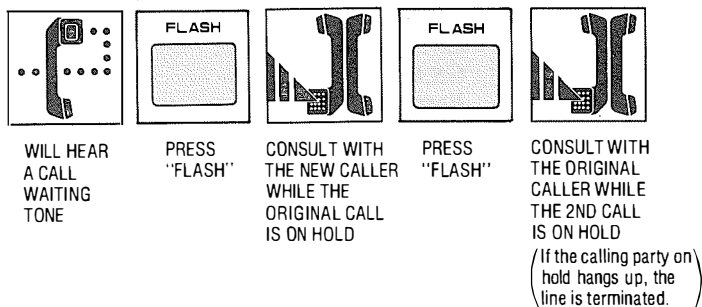

Description

Allows extension user to access features of the central office or host PBX. (example: call waiting feature can be supplied by central office.)

Operation

Call Waiting-Outside Line

1. While having a conversation, another party calls and a call waiting tone is heard.
2. Press the FLASH button.
 - The original call is placed on hold and the new call can be answered.
3. Press the FLASH button again.
 - The original caller can be spoken to again and the new call is placed on hold.
 - If the calling party on hold hangs up, the line is terminated.

Conditions

- The external feature (call waiting) can only be accessed when engaged on an outside call. The above-mentioned example shows you one of the procedures.
- "Flash" can be stored into memory in the same way as "Storage" on page 3-4.
- You may access some features of host PBX using the Flash button. If KX-T30810 is connected to host PBX and flash operation is required, follow the procedure of flash operation which is required in the host PBX.

Pulse/Tone Conversion

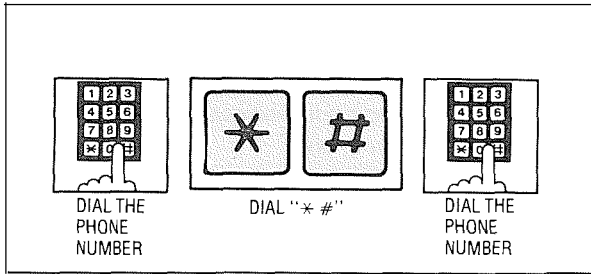

Description

When the dialing mode is required to change a pulse mode to a tone mode in one dialing sequence, this feature is used.

(e.g. computer-accessed long distance service)

Operation

1. Dial the phone number. (pulse mode)
2. Dial (* #).
3. Dial the phone number. (tone mode)

Conditions

- When you dial using this feature, you must use the line set to a pulse mode.
- Phone number after dialing "* #" will change to tone mode.

Example: Computer-accessed long distance service

- Local access telephone number of the alternate long distance service company 765-4321, Authorization no. 0123456, Long distance no. 543-210-9876
- Pulse mode is required by local access telephone number of the alternate long distance Service company.
- Service of MCI, SPRINT, METRO or other systems is used.

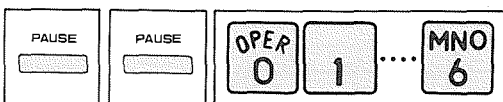
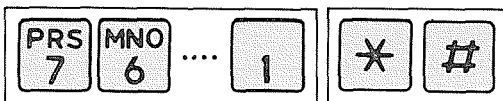

Time Setting

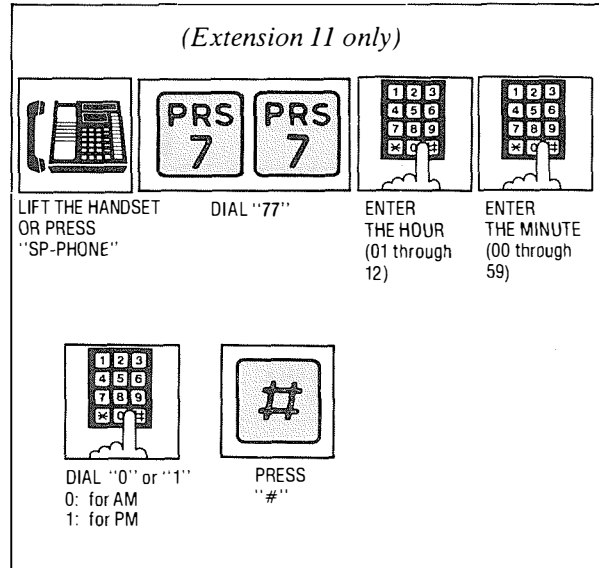

Description

Entry of the current time.

Operation

1. Lift the handset or press the SP-PHONE button on extension 11.
2. Dial (77).
3. Enter the hour with 2 digits. (01 through 12)
4. Enter the minute with 2 digits. (00 through 59)
5. Dial (0) for AM or (1) for PM.
6. Press the # button.
7. Wait for the confirmation tone.

Conditions

- Instantly after pressing the # button, new time counting will start.
- Time setting is done through extension 11 only.

Intercom Alerting Mode

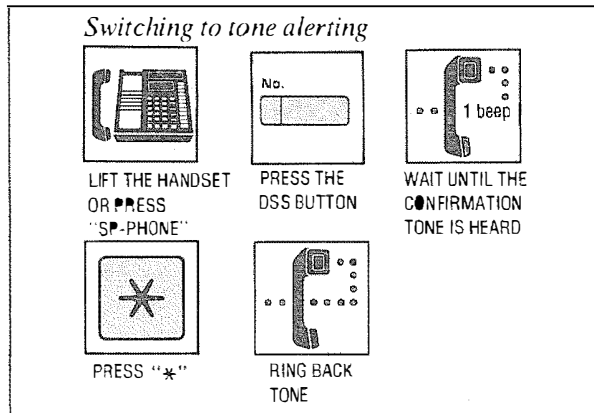

Description

"Voice alerting" (through built-in speaker) that is established at the called party's extension, can be switched to "Tone alerting" (ringing).

Operation

1. Lift the handset or press the SP-PHONE button.
2. Press the DSS button or dial the extension number.
3. Wait for confirmation tone after inter office calling.
4. Press the * button.
The ring back tone will be heard.
Tone Ringer on the called party's extension will be ready to be activated.

Conditions

- This feature required to be set beforehand in the KX-T30810. For programming, see page 2-29.

Busy Lamp Field

Description

The indicators corresponding to the DSS (Direct Station Selection) buttons and the ICM (Intercom) button will indicate the status of the extension in progress.

Explanation

• DSS indicator light

Light	Status
off	idle
on	occupied (in use)

• ICM indicator light

Light	Status
off	idle
on	in use for intercom
slow flashing	on hold
flashing in groups of 2	on exclusive hold
quick flashing	receiving an incoming intercom call

• CO indicator light

Light	Status
off	idle
on (green color)	in use
slow flashing (green color)	on hold
flashing in groups of 2 (green color)	on exclusive hold
on (red color)	in use at another extension
slow flashing (red color)	on hold at another extension
quick flashing (red color)	receiving an incoming outside call

Duration Time of Call Display

Description

The elapsed time (from dialing to replacing handset) on originating outside calls will be displayed.

Operation

None

Conditions

- When intercom calls, the duration time of conversation is not displayed.
- “DURATION” will be displayed.
- Refer to “Duration Time Count Start Mode” on page 2-25.

Lockout

Description

If a handset remains off hook or is disconnected at the other end, a reorder tone will be heard. When “Calling Party Control (CPC) Signal” mode is set to “DISABLE”, the reorder tone will not be heard. (see page 2-28.)

Operation

None

Conditions

- The party whose handset remains off-hook will hear a reorder tone to indicate that the call is disconnected.

Mixed Station Dialing

Description

Any telephone instrument, whether (KX-T30820, KX-T30830, KX-T30850 for exclusive use), standard rotary phone (10 pps, 20 pps), or standard touch tone phone, may be used as an extension of the KX-T30810.

Operation

None

Power Failure Transfer

Description

In the event of a power failure each CO will be connected to assigned extension.

- CO 1 is assigned to extension 11.
- CO 2 is assigned to extension 12.
- CO 3 is assigned to extension 13.

Operation

- If extension 11, 12 or 13 is connected the KX-T30830, the Power failure switch of the KX-T30830 is set to “ON”.

If dialing cannot be done, set the Dialing mode switch to other position (TONE or PULSE).

Conditions

- During power outage, all features are lost except for incoming and outgoing CO calls from extension 11, 12 and 13.
- If extension 11, 12 or 13 is connected the KX-T30820 or KX-T30850, disconnect KX-T30820 or KX-T30850 and connect the KX-T30830 or a standard telephone.
- There is no memory loss except for the camp-on, saved number redial and the last number redial during power failure, memory is protected by 21 day rechargeable battery. Rechargeable battery is good for 5 years.
- The Backup Adaptor (KX-A16) is available as a Backup power supply to the KX-T30810 to operate all the features in the event of power failure. Refer to page 1-13.

Specification of KX-A16

3 “Sealed lead-acid Batteries” (12 V, 6.5 AH)
Backup duration is greater than 4 hours in average usage.

(one outside call and one intercom call)
simultaneously in continuous operation.)

Station Programming

Call Forwarding

To set call forwarding:



LIFT THE HANDSET
OR PRESS
"SP-PHONE"

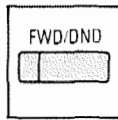

PRESS
"FWD/DND"

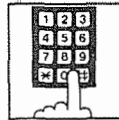

DIAL THE
EXTENSION
NUMBER



HANG UP OR
PRESS
"SP-PHONE"

To cancel:



LIFT THE HANDSET
OR PRESS
"SP-PHONE"

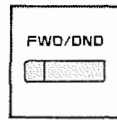

PRESS
"FWD/DND"



DIAL "0"



HANG UP OR
PRESS
"SP-PHONE"

Description

All outside or intercom calls to your extension can be forwarded to another extension automatically, during your absence.

Operation

To enable

1. Lift the handset or press the SP-PHONE button.
2. Press the FWD/DND button.
3. Dial number of extension to which calls are to be forwarded (11 through 18).
The indicator light of the FWD/DND button will flash slowly.
Confirmation tone will be heard.
"FORWARDING EXT" will be displayed.
4. Replace the handset back on the cradle or press the SP-PHONE button.

To cancel

1. Lift the handset or press the SP-PHONE button.
2. Press the FWD/DND button.
3. Dial (0).
The indicator light of the FWD/DND button will be off.
Confirmation tone will be heard.
"FWD/DND CANCEL" will be displayed.
4. Replace the handset back on the cradle or press the SP-PHONE button.

Conditions

- Do Not Disturb is cancelled when call forwarding is established.
- If a call is directed to the forwarding extension, the forwarded extension will ring but the originating extension will not ring.
- Recall for camp-on and Hold recall are not forwarded.

• The tone (busy tone or do not disturb tone etc.) the caller receives depends on the condition of the forwarded extension.

do not disturb tone

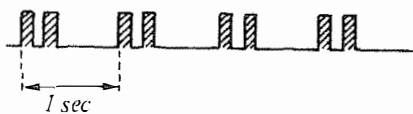

• When an intercom call to the forwarding extension is originated from the forwarded extension, the forwarded extension user hears reorder tone.

reorder tone: (two beeps a second)

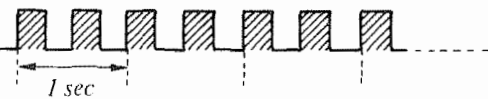

• An extension can not accommodate more than one forwarded extension. At each time of newly setting "Call Forwarding", a destination (forwarded extension code) will be renewed. Old entry will be cancelled.

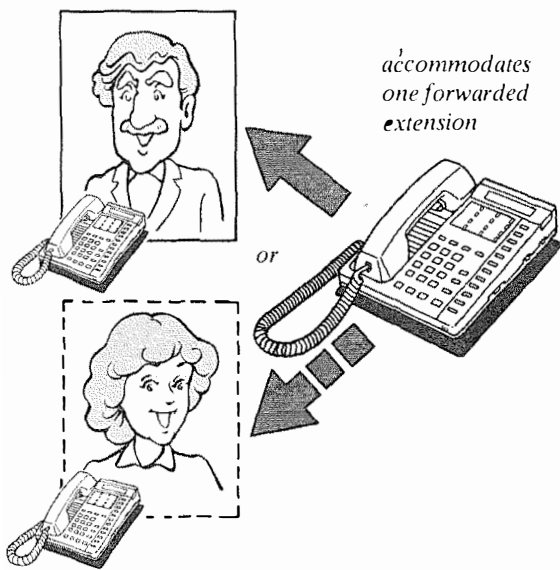

• If extension A is forwarding all calls to extension B and B is forwarding all calls to C, if any extension calls A, they will be connected to C. (If you attempt to forward a call to a forwarding extension, reorder tone is heard instead of confirmation tone to prevent an endless loop.)

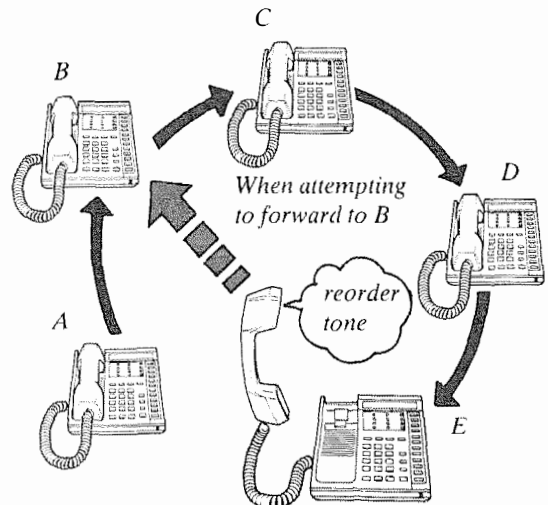
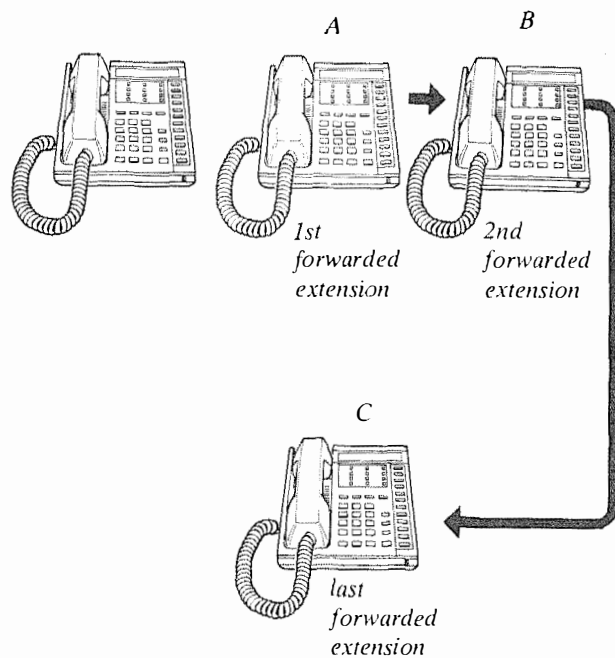

Reorder tone will be produced to prevent an endless loop.

Dial Call Pickup Deny

Setting



LIFT THE HANDSET
OR PRESS
"SP-PHONE"

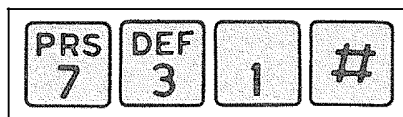

DIAL "731#"



HANG UP OR
PRESS
"SP-PHONE"

To cancel



LIFT THE HANDSET
OR PRESS
"SP-PHONE"

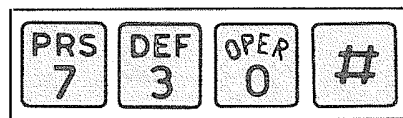

DIAL "730#"

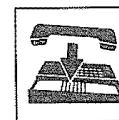

HANG UP OR
PRESS
"SP-PHONE"

Description

Allows you to prohibit any other extension user from answering calls directed to you.

Conditions

From your extension which is in the "Dial Call Pickup Deny" mode, you may call (outside or intercom).

Operation

1. Lift the handset or press the SP-PHONE button.
2. Dial (731#).
Wait for confirmation tone. "C.PICKUP DENY" will be displayed.
3. Hang up or press the SP-PHONE button.

To cancel,

1. Lift the handset or press the SP-PHONE button.
2. Dial (730#).
Wait for confirmation tone. "C.PICKUP ALLOW" will be displayed.
3. Hang up or press the SP-PHONE button.

Do not Disturb

Setting



LIFT THE HANDSET
OR PRESS
"SP-PHONE"

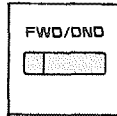

PRESS
"FWD/DND"

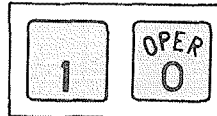

DIAL "10"

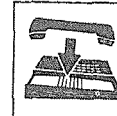

HANG UP OR
PRESS
"SP-PHONE"

To cancel



LIFT THE HANDSET
OR PRESS
"SP-PHONE"



PRESS
"FWD/DND"

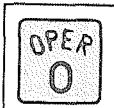

DIAL "0"



HANG UP OR
PRESS
"SP-PHONE"

Description

Each extension can be individually programmed from receiving outside or intercom calls.

Conditions

- When "Do not Disturb" is entered, "Call Forwarding" will be cancelled, if entered.
- "Do not Disturb" does not prevent the extension from recall for recalling for on-hold and camp-on.

Operation

1. Lift the handset or press the SP-PHONE button.
2. Press the FWD/DND button.
3. For setting, dial (10).
The indicator of FWD/DND button will be lit.
"DO NOT DISTURB" will be displayed.
Wait for confirmation tone. For cancellation, dial (0).
The indicator of the FWD/DND button will go out.
4. Hang up or press the SP-PHONE button.

Data Line Security

Setting

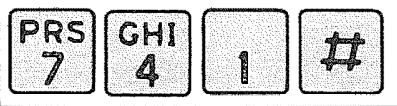
LIFT THE HANDSET
OR PRESS
"SP-PHONE"

DIAL "741 #"

**HANG UP OR
PRESS
"SP-PHONE"**

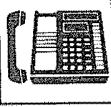
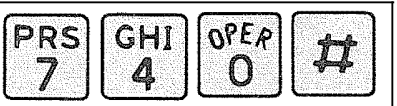

To Cancel

LIFT THE HANDSET
OR PRESS
"SP-PHONE"

DIAL "740 #"

**HANG UP OR
PRESS
"SP-PHONE"**

Description

This feature provides security when transmitting data through an extension of KX-T30810.

- Call waiting tone or hold time reminder tone from KX-T30810 are prohibited in this mode.

Operation

1. Lift the handset or press the SP-PHONE button.
2. For setting, dial (741#) and wait for confirmation tone.
For cancellation, dial (740#) and wait for confirmation tone.
3. Hang up or press the SP-PHONE button.

Conditions

- The parallel connection of the KX-T30830/ KX-T30820 and a data terminal equipment is impossible.

Saved Number Redial

Programming

When the called line is busy or while you are speaking on the CO Line;

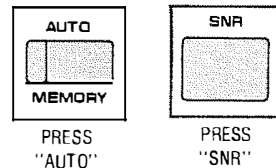

Dialing

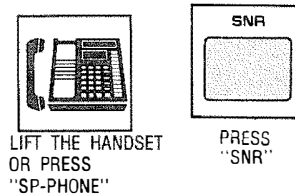

Description

The desired phone number on an outgoing call to CO Line can be stored and then redialed.

Programming

While speaking on the CO Line or when the called party is busy.

1. Press the AUTO button.
2. Press the SNR button.

- The phone number can not be stored even if you press the AUTO and SNR buttons after hang up.

Dialing

1. Lift the handset or press the SP-PHONE button.
2. Press the SNR button.

- You may press the CO button to select the CO line directly after lifting the handset or pressing the SP-PHONE button.

Conditions

- Up to 32 digits can be stored and redialed.

Flexible Night Service

(Extension 11 only)

To enable night service: (To disable day service)



LIFT THE HANDSET
OR PRESS
"SP-PHONE"

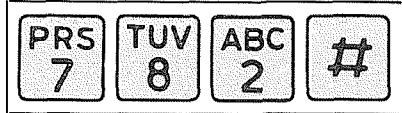

DIAL "782#"



HANG UP OR
PRESS
"SP-PHONE"

To disable night service: (To enable day service)



LIFT THE HANDSET
OR PRESS
"SP-PHONE"

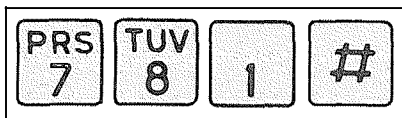

DIAL "781#"



HANG UP OR
PRESS
"SP-PHONE"

Description

Normal system operation is set for day time. Night service allows for the outward dialing and incoming ringing assignments to be rearranged via programming.

Night service is enabled or disabled through extension 11 using this feature, at any time. Without activating this feature, the day/night services are automatically switched at pre-determined time (9:00 AM and 5:00 PM for default time) by the internal clock if the Switching Mode (Day/Night Service) is selected "AUTO" mode in the KX-T30810.

Refer to "Switching Mode (Day/Night Service)" page 2-10 and "Starting time (Day/Night Service)" page 2-11.

Operation

1. Lift the handset or press the SP-PHONE button of extension 11.
2. Dial (782#) and wait for confirmation tone. Night service is enabled. "NIGHT MODE" will be displayed.
3. To return to day service, dial (781#) and wait for confirmation tone. "DAY MODE" will be displayed.
4. Hang up or press the SP-PHONE button.

When the unit is not in use, the present mode selected will be shown by pressing the # button.

Station Program Clear

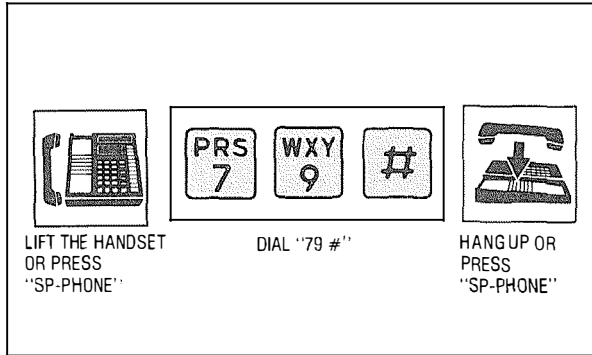

Description

Dialing (79 #) will clear the following station programs on an extension.

- Background Music
- Call Forwarding
- Data Line Security
- Dial Call Pickup Deny
- Do not Disturb

Operation

1. Lift the handset or press the SP-PHONE button.
2. Dial (79 #) and wait for confirmation tone. "EXT DATA CLEAR" will be displayed.
3. Hang up or press the SP-PHONE button.

OPERATION FOR STANDARD TELEPHONE

(rotary and touch tone phones)

To Make Calls

Inter Office Calling (Intercom) (see page 3-1)

Description

Station to station dialing within the KX-T30810 system.

Operation

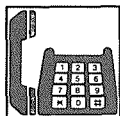

LIFT THE HANDSET

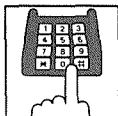

DIAL EXTENSION NUMBER (11 through 18)

Speed Dialing (see page 3-3)

Description

There are 100 memory locations of system speed dialing available.

Operation

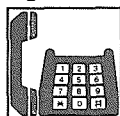

LIFT THE HANDSET

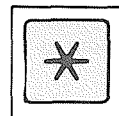

DIAL "*"

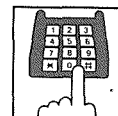

DIAL SPEED ACCESS CODE (00 through 99)

- It is no need to access a CO line.
- A rotary phone is not available for the speed calling.
- Continuous use of speed dialing is impossible.

Outward Dialing (see page 3-2)

Automatic Line Access

Description

Each extension can automatically select an idle CO (Central Office) Line within the KX-T30810.

Operation

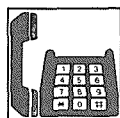

LIFT THE HANDSET

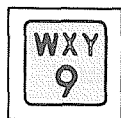

DIAL "9"

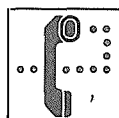

WAIT FOR C.O. DIAL TONE

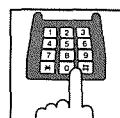

DIAL TELEPHONE NUMBER

Calling Doorphone (see page 3-6)

Description

Up to two doorphones (KX-T30865) can be connected to the KX-T30810.

Operation

Doorphone 1

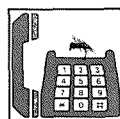

LIFT THE HANDSET

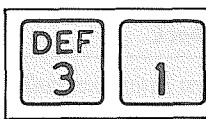

DIAL "31"

Individual Line Access

Description

Any of the 3 CO Lines may be selected by dial access.

Operation

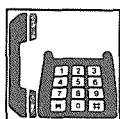

LIFT THE HANDSET

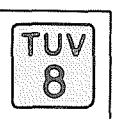

DIAL "8"

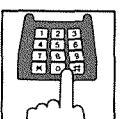

DIAL CO NUMBER (1 through 3)

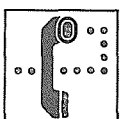

WAIT FOR C.O. DIAL TONE

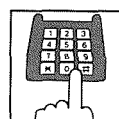

DIAL TELEPHONE NUMBER

Doorphone 2

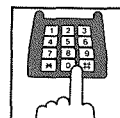

LIFT THE HANDSET

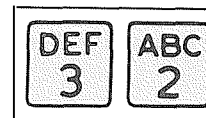

DIAL "32"

When a Line is Busy

Automatic Call Back Busy

Description

If the intercom extension or outside line you have dialed is busy, you will be automatically called back when the extension or the outside line becomes free using this function.

This feature is also known as camp-on.

Operation

For Outside Calls

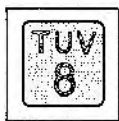

DIAL "8"

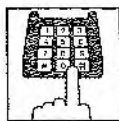

DIAL CO NUMBER
(1 through 3)

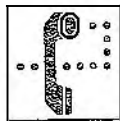

YOU WILL
HEAR A BUSY
TONE



DIAL "6"

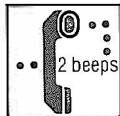

CONFIRMATION
TONE



HANG UP

For Intercom Calls

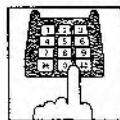

DIAL EXTENSION
NUMBER
(11 through 18)



YOU WILL
HEAR A BUSY
TONE



DIAL "6"



CONFIRMATION
TONE

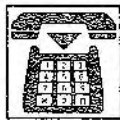

HANG UP

When hearing a ring back

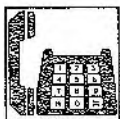

LIFT THE
HANDSET

- When intercom calls, you will hear the ring back tone.
- When outside calls, you will hear the dial tone from CO.

- A call back busy cannot be activated on an extension which has a call on hold.

Busy Station Signaling

Description

If the extension you have dialed is busy, you can inform that extension that another intercom call is reaching by three beeps. For use of this feature, the other extension is required to be set this feature beforehand in the KX-T30810.

Operation

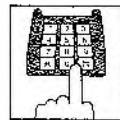

DIAL EXTENSION
NUMBER
(11 through 18)

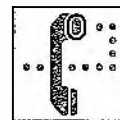

YOU WILL
HEAR A BUSY
TONE

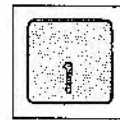

DIAL "1"

- To answer your signal, see "Call Waiting" on page 4-4.

Last Number Redial

Description

The last phone number dialed on an outgoing call to CO can be redialed.

Operation

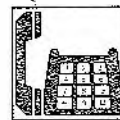

LIFT THE
HANDSET

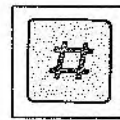

PRESS "#"

- You may dial "80" instead of pressing the "#" button.

To Receive Calls

Answer (see page 3-9)

Operation



LIFT THE
HANDSET

Dial Call Pickup (see page 3-10)

Description

An extension user can answer any ringing extension within their own pickup group.

Operation

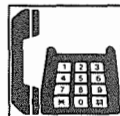

LIFT THE HANDSET



DIAL "40"

Directed Call Pickup (see page 3-10)

Description

An extension may answer an incoming call that is ringing at another extension regardless of pickup group.

Operation

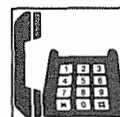

LIFT THE HANDSET



DIAL "4"

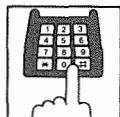

DIAL THE RINGING
EXTENSION NUMBER
(11 through 18)

Call Park Retrieve (see page 3-11)

Description

Allows extension user to retrieve a call (inter-com or outside) on hold at any extension.

Operation

To Park a Call

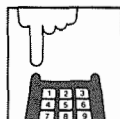

FLASH
HOOKSWITCH

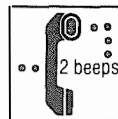

CONFIRMATION
TONE



REPLACE
HANDSET

- Do not depress hookswitch for more than one second, or party will be disconnected.

To Retrieve a Parked Call at Any Other Extension

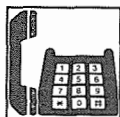

LIFT THE
HANDSET

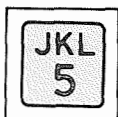

DIAL "5"

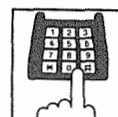

DIAL PARKED
EXTENSION
NUMBER

Doorphone (see page 3-12)

Operation

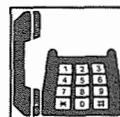

LIFT THE
HANDSET

While Having a Conversation

Call on Hold *(see page 3-13 and 3-15)*

Description

If you wish to leave your phone unattended but want the caller you are in conversation with to wait, call on hold may be used. Intercom and outside calls may be placed on hold.

Operation

To Place a Call on Hold

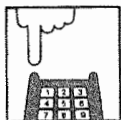

FLASH
HOOKSWITCH

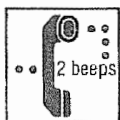

CONFIRMATION
TONE

Ⓢ Do not depress hookswitch for more than one second, or party will be disconnected.

To Cancel

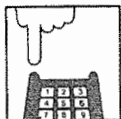

FLASH
HOOKSWITCH

Call Splitting *(see page 3-20)*

Description

Allows station user to alternate between two parties, either intercom or outside.

Operation



FLASH
HOOKSWITCH

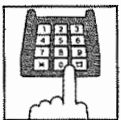

DIAL SECOND
PARTY



CONSULT 2ND PARTY
1ST PARTY ON HOLD

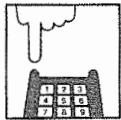

FLASH
HOOKSWITCH



2ND PARTY ON HOLD
1ST PARTY IN
CONSULTATION

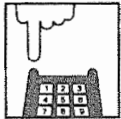

FLASH
HOOKSWITCH



1ST PARTY ON HOLD
2ND PARTY IN
CONSULTATION

Conference *(see page 3-17)*

Description

Allows for up to a three party conference, (2-outside/1-inside) (1-outside/2-inside) or (3-inside).

Operation

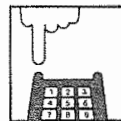

FLASH
HOOKSWITCH
PUTS 1ST PARTY
ON HOLD

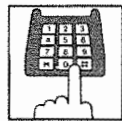

DIAL 2ND
PARTY



CONSULT WITH
2ND PARTY
1ST PARTY
ON HOLD

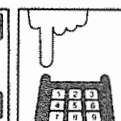

FLASH
HOOKSWITCH

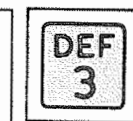

DIAL "3"
(3-party conference)
now established.

To Hold one Caller and Talk to the Other Caller

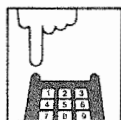

FLASH
HOOKSWITCH



2ND PARTY
ON HOLD
1ST PARTY IN
CONSULTATION

Call Waiting *(see page 3-18)*

Description

Calls waiting tone during a conversation indicates there is a new incoming CO Line call or Intercom call.

This feature required to be set beforehand in the KX-T30810. For programming, see page 2-24.

Operation



WILL HEAR
CALL WAITING
TONE

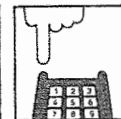

FLASH
HOOKSWITCH
PUTS 1ST PARTY
ON HOLD



HANG UP

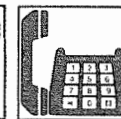

LIFT THE
HANDSET



CONSULT NEW
CALLER
1ST PARTY
ON HOLD

Ⓢ When you use the hold button of a standard telephone, above-mentioned feature is not available.

Ⓢ To terminate the original call and talk to the 2nd call, hang up and then lift the handset. (You don't need to flash the hookswitch.)

While Having a Conversation

(cont.)

Call Transfer (see page 3-19)

Description

Outside or intercom calls may be transferred to any extension manually.

Operation

To Transfer After Other Extension Answers

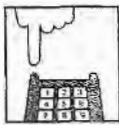

FLASH HOOKSWITCH

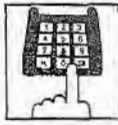

DIAL EXTENSION NUMBER



ANNOUNCE AND WAIT FOR AN ANSWER



HANG UP

To Transfer without Announcing the Other Extension



FLASH HOOKSWITCH

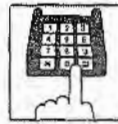

DIAL EXTENSION NUMBER



HANG UP

To Retrieve the Call

If the other extension did not receive the transferred call within 30 seconds after the call has been transferred, the call will return to you. In this case:



LIFT THE HANDSET

To change the party to whom a call is transferred before hanging up

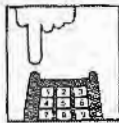

FLASH HOOKSWITCH TO RETRIEVE THE CALL



FLASH HOOKSWITCH

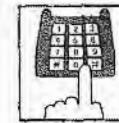

DIAL EXTENSION NUMBER

Paging

Paging All Extensions (see page 3-21)

Description

Allows paging to all extensions.

Operation

To Access



LIFT THE HANDSET



DIAL "34"



CONFIRMATION TONE



PAGE



WAIT FOR AN ANSWER AND TALK

- Page will be heard only from the built-in speaker of KX-T30830, KX-T30850 or KX-T30820. It will not be heard from the built-in speaker of standard telephone.



Paging Group (see page 3-22)

Description

Allows paging to either of two groups.

Operation

To Access

For Pickup Group 1



LIFT THE HANDSET



DIAL "35"

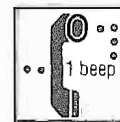

CONFIRMATION TONE



PAGE



WAIT FOR AN ANSWER AND TALK

- For Pickup Group 2: At step 2 above, dial 36 instead of 35.

- Page will be heard only from the built-in speaker of KX-T30830, KX-T30850 or KX-T30820. It will not be heard from the built-in speaker of standard telephone.



Paging (cont.)

Paging-External (see page 3-22)

Description

Allows access to external paging equipment.

Operation

To Access

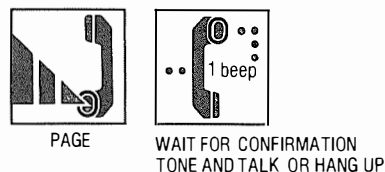
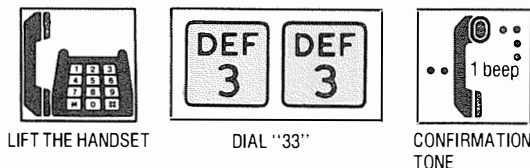

- Page will be heard from external paging equipment.



Paging And Transfer (see page 3-23)

Operation

To Transfer a Call to the Paged Person

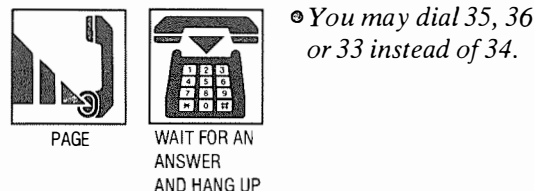
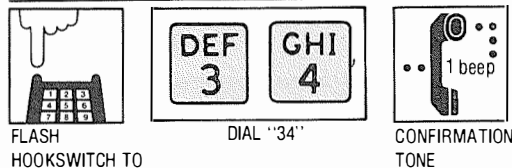

- You may dial 35, 36 or 33 instead of 34.

Paging-Answer (see page 3-23)

Description

A page from built-in speaker or external paging equipment can be answered from any extension.

Operation

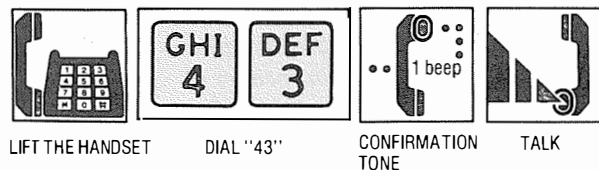

Use of Other Features

External Feature Access (see page 3-26)

Description

Allows extension user to access features of the central office or host PBX. (example: call waiting feature can be supplied by central office.)

- The external feature (call waiting) can only be accessed when engaged on an outside call.
- The following example shows you one of the procedures.

Operation

Call Waiting—Outside Line

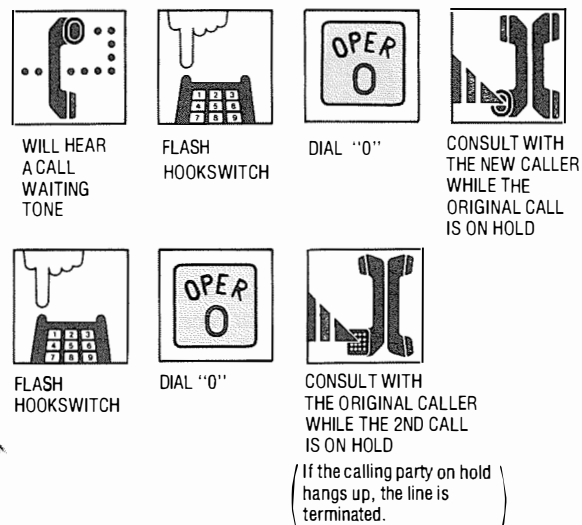

- Flashing the hookswitch and dialing 0 means flash operation.
- If KX-T30810 is connected to host PBX and flash operation is required, follow the procedure of flash operation which is required in the host PBX.

Use of Other Features (cont.)

Pulse/Tone Conversion (see page 3-27)

Description

When the dialing mode is required to change a pulse mode to a tone mode in one dialing sequence, this feature is used.

(e.g. computer-accessed long distance service)

Operation

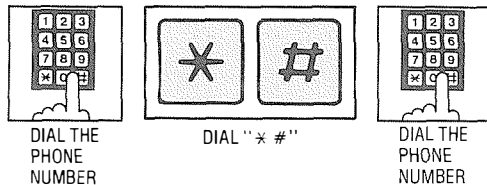

- When you dial using this feature, you must use the line selected in a pulse mode.
- Phone number after dial “* #” will change to tone mode.
- A rotary phone is not available for the Pulse/Tone Conversion.
- You should press “*” and “#” buttons within 10 seconds after the number of the long distance service company.

■ When you use a standard telephone equipped with automatic dialer, be careful the followings:

Example: Computer-accessed long distance service

- Local access telephone number of the alternate long distance service company 765-4321, Authorization no.0123456, Long distance no. 543-210-9876
- Pulse mode is required by local access telephone number of the alternate long distance Service company.
- Service of MCI, SPRINT, METRO or other systems is used.

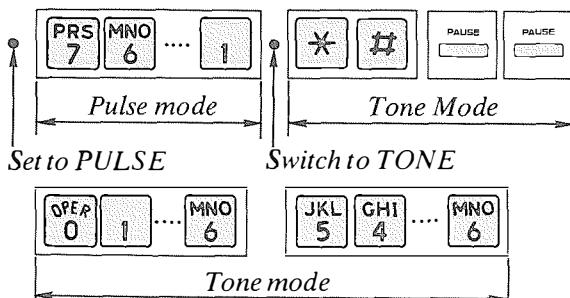

Store the long distance service company no. in PULSE mode, and switch to the TONE mode to memory the following numbers.

Intercom Alerting Mode (see page 3-28)

Description

“Voice alerting” (through built-in speaker) that is established at the called party’s extension, can be switched to “Tone alerting” (ringing).

• This feature required to be set beforehand in the KX-T30810. For programming, see page 2-29.

• A rotary phone is not available.

Operation

Switching to Tone Alerting

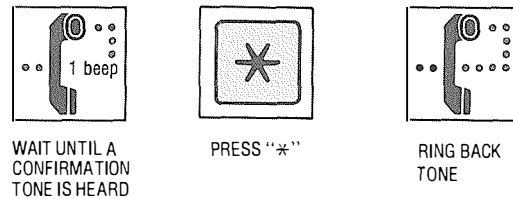

- You should press “*” button within 10 seconds after the dialing.

Station Programming

You may dial "0" instead of pressing the "#" button.

Call Forwarding *(see page 3-30)*

Description

All outside or intercom calls to your extension can be forwarded to another extension automatically during your absence.

Operation

Setting

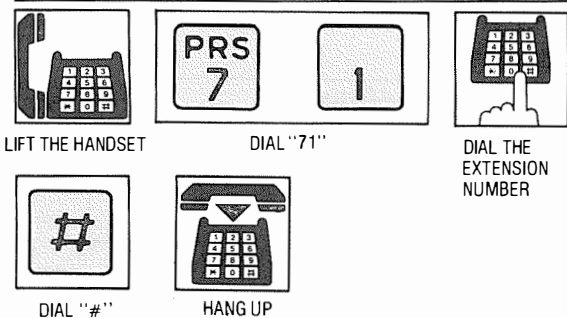

The diagram shows the steps for setting call forwarding: 1. Lift the handset. 2. Dial "7" (PRS) and "1" (DEF). 3. Dial the extension number. 4. Dial "#". 5. Hang up.

To Cancel

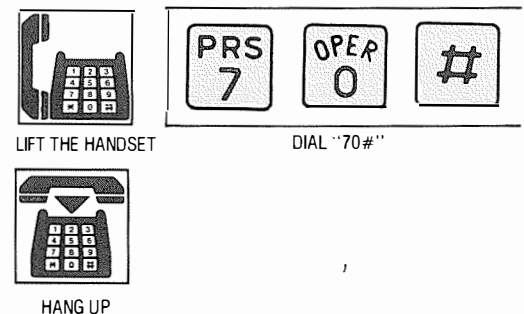

The diagram shows the steps to cancel call forwarding: 1. Lift the handset. 2. Dial "7" (PRS) and "0" (OPER). 3. Dial "#". 4. Hang up.

Dial Call Pickup Deny *(see page 3-32)*

Description

Allows you to prohibit any other extension user from answering calls directed to you.

Operation

Setting

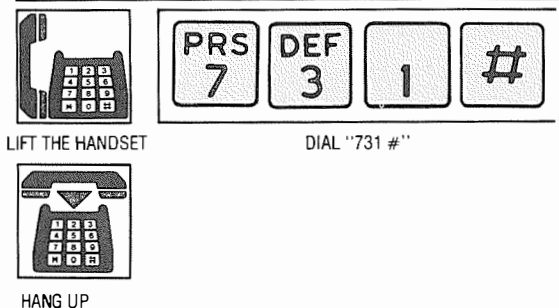

The diagram shows the steps for setting dial call pickup deny: 1. Lift the handset. 2. Dial "7" (PRS), "3" (DEF), "1", and "#". 3. Hang up.

To Cancel

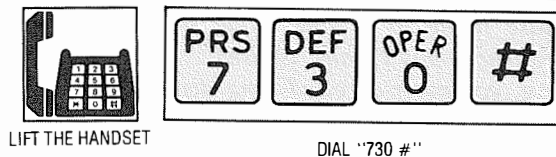

The diagram shows the steps to cancel dial call pickup deny: 1. Lift the handset. 2. Dial "7" (PRS), "3" (DEF), "0" (OPER), and "#". 3. Hang up.

Do not Disturb *(see page 3-33)*

Description

Each extension can be individually programmed from receiving outside or intercom calls.

Operation

Setting

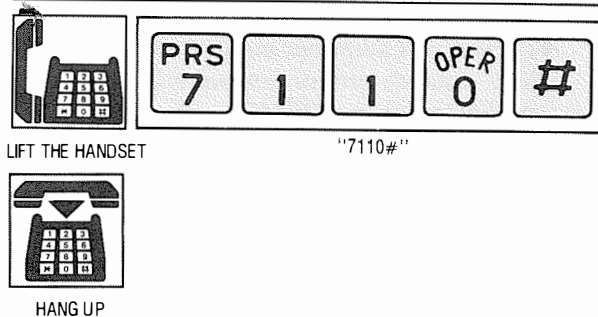

The diagram shows the steps for setting do not disturb: 1. Lift the handset. 2. Dial "7" (PRS), "1", "1", "0" (OPER), and "#". 3. Hang up.

To Cancel

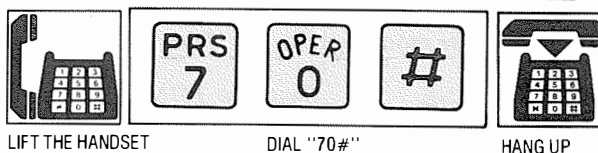

The diagram shows the steps to cancel do not disturb: 1. Lift the handset. 2. Dial "7" (PRS), "0" (OPER), and "#". 3. Hang up.

Station Programming (cont.)

Data Line Security *(see page 3-34)*

Description

This feature provides security when transmitting data through an extension of the KX-T30810. Call waiting or hold time reminder tone from KX-T30810 are prohibited in this mode.

Operation

Setting



LIFT THE HANDSET

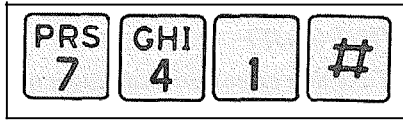

DIAL "741#"

To cancel

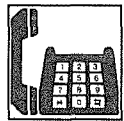

LIFT THE HANDSET

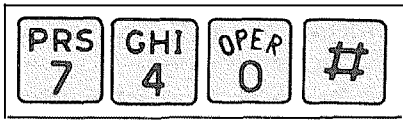

DIAL "740#"

Station Program Clear *(see page 3-36)*

Description

Dialing (79 #) will clear the following station programs on an extension.

Call Forwarding
Data Line Security
Dial Call Pickup Deny
Do not Disturb

Operation

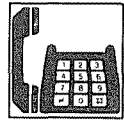

LIFT THE HANDSET

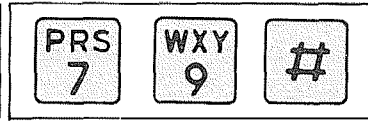

DIAL "79 #"

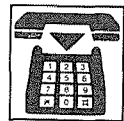

HANG UP

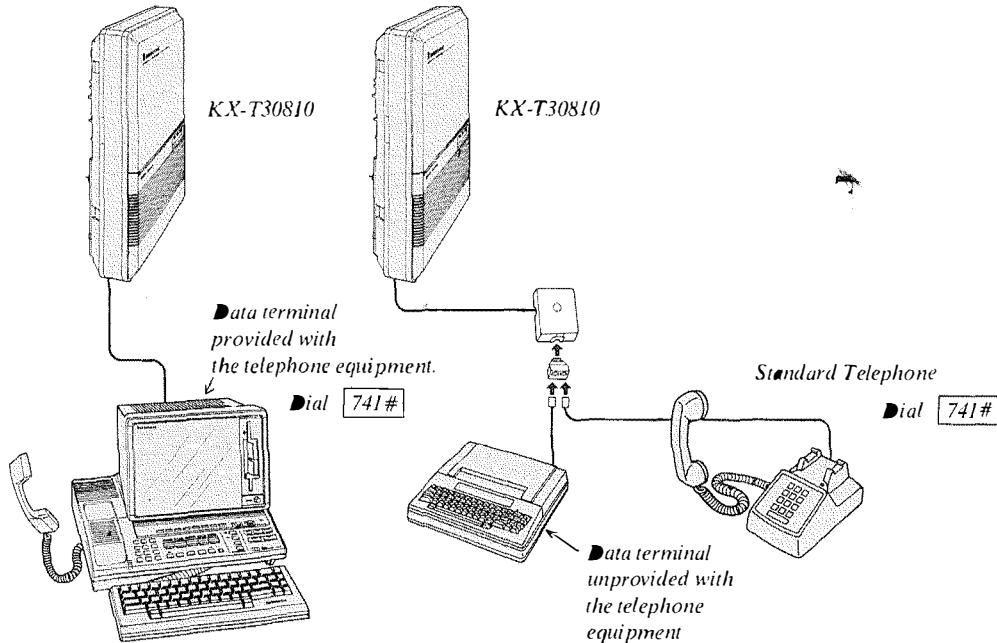

• This mode cannot prevent external call waiting tone from coming into KX-T30810 system. We recommend that this mode is established on a line which has no special telephone company services.

TROUBLESHOOTING

During Installation

<i>PROBLEM</i>	<i>PROBABLE CAUSE</i>	<i>POSSIBLE SOLUTION</i>
<i>Extension does not operate.</i>	<p><i>Bad connection between system and extension</i></p> <p><i>The system program switch of the KX-T30810 is set to PROGRAM.</i></p> <p><i>A telephone with an A-AI relay is connected.</i></p> <p><i>Bad extension</i></p>	<p><i>Take that extension and plug it into the same extension port using a short telephone cord. If telephone does not work, connection between the system and the extension must be repaired.</i></p> <p><i>Set to SET except when programming.</i></p> <p><i>Use a 2 wires cord. Set the A-AI relay switch of the telephone to OUT or OFF.</i></p> <p><i>Take that extension and plug it into another extension port that is working. If the telephone does not work, replace the phone.</i></p>
<i>Improper reset operation</i>		<i>Press the Reset Button.</i>
<i>Call is disconnected during connection operation.</i>	<i>Instantaneous drop of DC voltage from Central Office (or host PBX) when in operation of connection between C.O. and system.</i>	<p><i>Program for a no CPC signal (CPC means Calling Party Control)</i></p> <p><i>Set the calling party control signal to "DISABLE".</i></p> <p><i>Refer to page 2-28.</i></p>
<i>Noise in external paging</i>	<i>Induced noise on the wire between System and an Amplifier.</i>	<p><i>Use a shielded cable as a connection wire between System and Amplifier.</i></p> <p><i>A shorter shielded cable is recommended.</i></p>
<i>Volume distortion from external music source</i>	<i>Excessive input level from external music source</i>	<i>Decrease the Output level of the external music source by using the Volume Control on the music source.</i>
<i>Speed dialing or One Touch Dialing does not function.</i>	<i>Bad programming</i>	<i>Enter the line access code (9, 81, 82, 83) into programming.</i>
<i>A dial tone (short tone continuously) was heard and telephone line hung up at once when accessing a outside during the speakerphone mode.</i>	<i>The host PBX may cause the line to hang up when the KX-T30810 was connected to it.</i>	<i>Use the handset instead of the speakerphone.</i>

During Connection

1. Connection between the Central Office and the KX-T30810

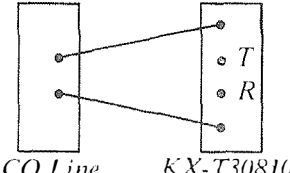
PROBLEM	CAUSE	SOLUTION
Cannot make or receive calls on the CO Lines.	CO Lines are connected to the H/L. 	Reconnect the CO Lines to the T/R of the telephone jack using the 2-conductor wiring cord.

2. Connection between the KX-T30810 and the extensions (KX-T30820 and KX-T30830)

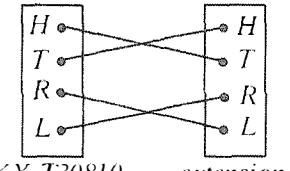
PROBLEM	CAUSE	SOLUTION
Cannot make calls when the SP-Phone button on the KX-T30820 (and KX-T30830) is pressed. The SP-Phone indicator does not light.	The T/R is connected to the H/L. 	Use the correct cord (inner 2 wires are for T/R and the outer 2 wires are for H/L).

3. Connection between the KX-T30810 and a standard telephone (with no polarity)

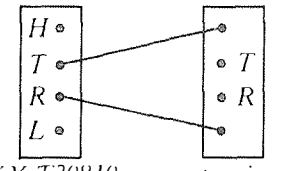
PROBLEM	CAUSE	SOLUTION
When the handset is lifted, nothing is heard.	The T/R is connected to the H/L. 	Use the correct cord (inner 2 wires are for T/R). *If a telephone equipped with an A-A1 relay is connected to the KX-T30810, set the A-A1 relay switch of the telephone to OFF.

4. Connection between the KX-T30810 and a standard telephone that is polarity sensitive

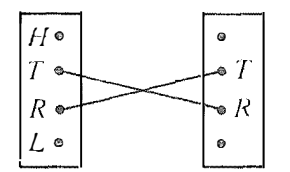
PROBLEM	CAUSE	SOLUTION
Dial tone cannot be heard when the handset is lifted.	The "T" is connected to the "R". 	Reverse the connections of the T/R.

During Operation

PROBLEM	PROBABLE CAUSE	POSSIBLE SOLUTION
Extension does not operate.	The Power failure switch of the KX-T30830 is set to ON.	Set the Power failure switch to OFF.
When speakerphone mode, nothing is heard.	The HANDSET/ HEADSET selector of the KX-T30830 is set to the "HEADSET" position.	When the headset is not used, set the HANDSET/ HEADSET selector to the "HANDSET" position.
The unit does not ring.	Ringer Volume Selector is set to "OFF".	Set to "HIGH" or "LOW".
During a power interruption, extensions 11, 12 and 13 do not operate.	<ul style="list-style-type: none"> • The Power failure switch of the KX-T30830 is set to OFF. • The dialing mode (tone or pulse) is improper. • KX-T30820 or KX-T30850 is connected. 	<ul style="list-style-type: none"> • Set the Power failure switch to ON. • Set the Tone/Pulse switch to the other position. • Disconnect the KX-T30820 or KX-T30850 and connect the KX-T30830 or a standard telephone.

Reset Button

If the system is not operating properly, use the Reset Button.

- Before using Reset Button, try again the system feature which does not work several times to confirm there definitely a problem.
- Pressing the Reset button will cause the followings.
 1. Camp-on to be cleared.
 2. Last number redial to be cleared.
 3. Saved number redial to be cleared.
 4. Calls on hold are terminated.
 5. Calls on exclusive hold are terminated.
 6. Calls in progress are terminated.
 Data that is stored in memory other than above mentioned will not be cleared by use of the Reset Button.



Note

If the system does not operate properly, push the Reset Button.

If still no difference occurs, switch the power off and on again after 5 minutes. If the system still does not work, switch the power off.

The following extensions will be directly connected to each of the central office lines (C.O.).

Extension 11...C.O.1

Extension 12...C.O.2

Extension 13...C.O.3

If the KX-A16 is connected to the system, switch off the power of the KX-A16.

DTMF Receiver Check

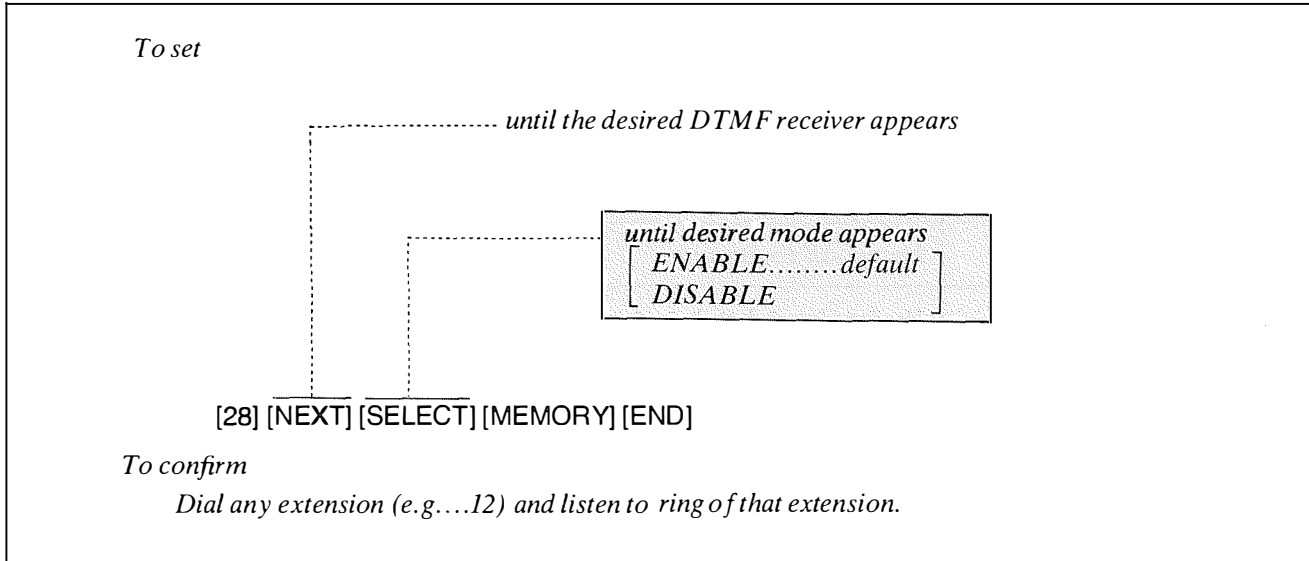

Description

DTMF (Dual Tone Multi Frequency) Receiver enables tone telephones to dial within the system.

To check the DTMF Receivers, activate the DTMF Receivers one at a time and confirm if the receiver can receive tone signals.

Operation at Extension 11

To Remove DTMF Receiver 2:

1. Set the System Program Switch to the PROGRAM position.
2. Dial (28) to enter the DTMF mode.
“DTMF RCVR SEL” will be displayed.
3. Press the NEXT button, twice.
“DTMF 1: ENABLE” and then
“DTMF 2: ENABLE” will be displayed.
4. Press the SELECT button to change to DISABLE.
“DTMF 2: DISABLE” will be displayed.
5. Press the MEMORY button.
6. Press the END button to return to the initial program mode.
7. Set the System Program Switch to the SET position.

Confirmation of DTMF Receiver 1:

1. Set the DIALING MODE (located on the rear of KX-T30830) switch to the TONE position.
2. Set the POWER FAILURE (located on the rear of KX-T30830) switch to the ON position.
3. Dial the extension number (e.g....12).
4. If DTMF Receiver is bad, do the following procedure for removing the DTMF Receiver after the next step on this section.
5. Set the POWER FAILURE Switch to the OFF position.

To check the DTMF Receiver 2, remove DTMF Receiver 1 and confirm that DTMF Receiver 2 is good by the procedures of “To Remove DTMF Receiver 1” and “Confirmation of DTMF Receiver 2”.

Conditions

- The “DISABLE” can not be established on both DTMF Receivers 1 and 2, at the same time.

Table of System Features

The following system features can be programmed into memory.

<i>Dial Plan Code</i>	<i>System Features</i>
Extension no. (11 through 18)	<i>Individual Inter Office Calling</i>
DEF 3 1 or DEF 3 ABC 2	<i>Calling Doorphone 1 or Doorphone 2</i>
DEF 3 DEF 3	<i>Paging—External</i>
DEF 3 GHI 4	<i>Paging All Extensions</i>
DEF 3 JKL 5 or DEF 3 MNO 6	<i>Paging Group 1 or 2</i>
GHI 4 GPEP 0	<i>Dial Call Pickup</i>
GHI 4 Extension no. (11 through 18)	<i>Directed Call Pickup</i>
GHI 4 DEF 3	<i>Paging Answer</i>
JKL 5 Extension no. (11 through 18)	<i>Call Park Retrieve</i>
MNO 6	<i>Camp-on</i>
PRS 7 GPEP 0 #	<i>Cancelling Call Forwarding or Do Not Disturb</i>
PRS 7 1 Extension no. (11 through 18) #	<i>Call Forwarding</i>
PRS 7 1 1 GPEP 0 #	<i>Do Not Disturb</i>
PRS 7 DEF 3 GPEP 0 #	<i>Cancelling Dial Call Pickup Deny</i>
PRS 7 DEF 3 1 #	<i>Dial Call Pickup Deny</i>
PRS 7 JKL 5 GPEP 0 #	<i>Cancelling Background Music</i>
PRS 7 JKL 5 1 #	<i>Background Music</i>
PRS 7 TUV 8 1 #	<i>Flexible Night Service—Day Mode</i>
PRS 7 TUV 8 ABC 2 #	<i>Flexible Night Service—Night Mode</i>

LIST OF TONES

	1 sec							
<i>Confirmation tone 1</i>								
<i>Confirmation tone 2</i>								
<i>Conference Confirmation tone</i>								
<i>Feature activation tone</i>								
<i>Dial tone</i>								
<i>Busy tone 1</i>								
<i>Busy tone 2</i>								
<i>Reorder tone</i>								
<i>Ringback tone</i>								
<i>Do not Disturb tone</i>								
<i>Call on hold tone</i>								
<i>Alarm tone</i>								
<i>Hold time reminder</i>								
<i>Call waiting tone</i>								

LIST OF RING TONES

	1 sec							
<i>CO calls (CO hold recall)</i>								
<i>Intercom calls (Intercom hold recall)</i>								
<i>Doorphone calls</i>								
<i>Recall for camp-on</i>								

FEATURE DESCRIPTION AND OPERATION

SPECIFICATION

General Description

1. Capacity	Outsides (CO) 3 Stations 8
2. Control Method	Stored Program CPU: 8 bits CPU, 4 bits CPU Control ROM: 48 KB, Control RAM: 8 KB
3. Switching	Space Division CMOS Crosspoint Switch
4. Power Supplies	Primary AC 120 V 60 Hz Secondary Station Supply Volt: +26 V, Circuit Volt: +5 V, +12 V, +18 V, +26 V Power Failure ●3 outsides assigned to stations (1 through 3)...power failure transfer ●System operation for 4 hours by optional Backup Adaptor.
5. Dialing	Outward Dial Pulse 10PPS Tone Dial Internal Dial Pulse 10PPS, 20PPS Tone Dial Mode Conversion DP-DTMF, DTMF-DP
6. Connector	Outsides (CO) Modular Jack (RJ-11) Station Modular Jack Paging Output Pin Jack (RCA JACK) External Music Input two-conductors Jack (MINIJACK 1/4 inch diameter)
7. EXT Connection	Cable 1 pair wire (Standard Telephone) 2 pair wire (KX-T30820/KX-T30830/KX-T30850)
8. Intercom parths	3

Characteristics

1. Station Loop Limit	KX-T30820/KX-T30830/KX-T30850 40 ohms Standard Telephone 600 ohms including set Doorphone 20 ohms
2. Minimum Leak Resistance	15,000 ohms
3. Maximum Number of Station Instruments per Line	1 (KX-T30820/KX-T30830/KX-T30850) or 3 (Standard telephone)
4. Ring Voltage	90 Vrms at 20 Hz depends on Ringing Load
5. Primary Power	120 Vac, 60 Hz, 0.4 A maximum
6. Central Office Loop Limit	1600 ohms maximum
7. Environmental Requirements	0-40°C, 10%-90%
8. Hookswitch Flash Timing Range	204-1000 msec

TELEPHONE COMPANY and F.C.C. REQUIREMENTS AND RESPONSIBILITIES

In compliance with the requirements of Part 68 of the F.C.C. Rules and Regulations for connection of terminal system (this device is classified as terminal system) to the telephone network and for your convenience, the following information is presented:

1. Notification to the Telephone Company

Customers connecting terminal equipment to the telephone network shall, upon request of the Telephone Company, inform the Telephone Company of the particular line(s) to which such connection is made, the F.C.C. registration number and (see label on bottom of unit.) ringer equivalence number of the registered terminal equipment.

The REN is useful to determine the quantity of devices you may connect to your telephone line and still have all of those devices ring when your telephone number is called. In most, but not all areas, the sum of the REN's of all devices connected to one line should not exceed five (5.0). To be certain of the number of devices you may connect to your line, as determined by the REN, you should contact your local telephone company to determine the maximum REN for your calling area.

2. Direct connection to A Party-line or Coin-operated Telephone Line is Prohibited

3. Incidence of Harm to The Telephone lines

Should Terminal Equipment cause harm to the Telephone Network, the Telephone Company shall, where practical, notify the customer that temporary discontinuance of service may be required. However, where prior notice is not practical, the Telephone Company may temporarily discontinue service forthwith, if such action is reasonable in the circumstances. In case of such unnotified temporary discontinuance of service, the Telephone Company shall:

- (a) Promptly notify the customer of such temporary discontinuance of service.
- (b) Afford the customer the opportunity to correct the situation which gave rise to the temporary discontinuance.
- (c) Inform the customer of the right to bring a complaint to the Commission pursuant to the procedures set out in Subpart E of Part 68 of FCC Telephone Equipment Rules.

4. Compatibility of The Telephone Network and Terminal Equipment

(a) Availability of telephone interface information.

Technical information concerning interface parameters and specifications not specified in FCC Rules, including the number of Ringers which may be connected to a particular telephone line, which is needed to permit Terminal Equipment to operate in a manner compatible with Telephone Company communications facilities, shall be provided by the Telephone Company upon customer's request.

(b) Changes in Telephone Company Communications Facilities, Equipment, Operations and Procedures.

The Telephone Company may make changes in its communications facilities, equipment, operations or procedures, where such action is reasonably required in the operation of its business and is not inconsistent with the rules and regulations in FCC Part 68 of the FCC Rules and Regulations. If such changes can be reasonably expected to render any customer Terminal Equipment incompatible with Telephone Company Communications Facilities, or require modification or alteration of such Terminal Equipment, or otherwise materially affect its use or performance, the customer shall be given adequate notice in writing, to allow the customer an opportunity to maintain uninterrupted service.

OTHERS

- *Keep the unit away from heating appliances and electrical noise generating devices such as fluorescent lamps, motors and television. These noise sources can interfere with the performance of the EASA-PHONE.*
- *This unit should be kept free of dust, moisture, high temperature and vibration, and should not be exposed to direct sunlight.*
- *Never attempt to insert wires, pins, etc. into the vents or other holes of this unit.*
- *If there is trouble, disconnect the unit from the telephone line. Plug the telephone directly into the telephone line. If the telephone operates properly, do not reconnect the unit to the line until the trouble has been repaired by an authorized Panasonic Factory Service Center. If the telephone does not operate properly, chances are that the trouble is in the telephone system, and not in the unit.*
- *Do not use benzine, thinner, or similar solvents. Do not use abrasive powder to clean the cabinet. Wipe it with a soft cloth.*

This equipment generates and uses radio frequency energy and if not installed and used properly, that is, in strict accordance with the manufacturer's instructions, may cause interference to radio and television reception. It has been type tested and found to comply with the limits for a Class B computing device in accordance with the specifications in Subpart J of Part 15 of FCC Rules, which are designed to provide reasonable protection against such interference in a residential installation. However, there is no guarantee that interference will not occur in a particular installation. If this equipment does cause interference to radio or television reception, which can be determined by turning the equipment off and on, the user is encouraged to try to correct the interference by one or more of the following measures:

- ...Reorient the receiving antenna*
- ...Relocate the equipment with respect to the receiver*
- ...Move the equipment away from the receiver*
- ...Plug the equipment into a different outlet so that equipment and receiver are on different branch circuits.*

If necessary, the user should consult the dealer or an experienced radio/television technician for additional suggestions. The user may find the following booklet prepared by the Federal Communications Commission helpful:

*"How to Identify and Resolve Radio-TV Interference Problems".
This booklet is available from the US Government Printing Office,
Washington, D.C., 20402, Stock No. 004-000-00345-4.*

WARNING: TO PREVENT FIRE OR SHOCK HAZARD, DO NOT EXPOSE THIS PRODUCT TO RAIN OR MOISTURE.

LIMITED WARRANTY

Panasonic Company or Panasonic Sales Company (collectively referred to as "PANASONIC") will repair this product with new or rebuilt parts, free of charge, in the U.S.A. or Puerto Rico for one (1) year from the date of original purchase in the event of a defect in materials or workmanship.

Batteries (if included)—New rechargeable batteries in exchange for defective rechargeable batteries for ten (10) days from the date of original purchase. Non-rechargeable batteries are not warranted.

Carry-in or mail-in service in the U.S.A. can be obtained during the warranty period from a Matsushita Services Company (MSC) Factory Servicenter listed in the Servicenter Directory. Or call 1-800-447-4700, toll free, to locate an authorized MSC Servicenter. Carry-in or mail-in service in Puerto Rico can be obtained during the warranty period by calling the telephone numbers listed in the Servicenter Directory (see page 5-11).

This warranty is extended only to the original purchaser. A purchase receipt or other proof of date of original purchase will be required before warranty performance is rendered.

This warranty only covers failures due to defects in materials or workmanship which occur during normal use. It does not cover damage which occurs in shipment or failures which are caused by products not supplied by Panasonic Company, Panasonic Sales Company or failures which result from accident, misuse, abuse, neglect, mishandling, misapplication, alteration, faulty installation, modification, or service by anyone other than a MSC Factory Servicenter or authorized MSC Servicenter or damage that is attributable to acts of God.

LIMITS AND EXCLUSIONS

There are no express warranties except as listed above.

PANASONIC COMPANY AND PANASONIC SALES COMPANY SHALL NOT BE LIABLE FOR INCIDENTAL OR CONSEQUENTIAL DAMAGES RESULTING FROM THE USE OF THIS PRODUCT, OR ARISING OUT OF ANY BREACH OF THIS WARRANTY. ALL EXPRESS AND IMPLIED WARRANTIES, INCLUDING THE WARRANTIES OF MERCHANTABILITY AND FITNESS FOR A PARTICULAR PURPOSE, ARE LIMITED TO THE APPLICABLE WARRANTY PERIOD SET FORTH ABOVE.

Some states do not allow the exclusion or limitation of incidental or consequential damages, or limitations on how long an implied warranty lasts, so the above exclusions or limitations may not apply to you.

This warranty gives you specific legal rights and you may also have other rights which vary from state to state.

If a problem with this product develops during the warranty period, you may contact your dealer or Servicenter. If the problem is not handled to your satisfaction, then write to the Consumer Affairs Division at the company address indicated on the back cover.

SERVICENTER LIST

To locate an Authorized Servicenter in Your Area within the Continental U.S.A.

DIAL TOLL FREE: 1-800-447-4700
24 Hours a Day, 7 Days a Week

Requests for assistance in obtaining repairs or technical information... contact any one of the following Service Administration offices:

NORTHEAST

2250 Cabot Blvd., West
Langhorne, PA 19047
215-741-0676

Covers:

CT, DE, ME, MD, MA,
NH, NJ, NY, PA, RI, VT,
VA, DC, WV, Eastern OH

MIDWEST

425 East Algonquin Road
Arlington Heights, IL 60005
312-981-4842

Covers:

IL, IN, IA, KS, KY, MI,
MN, MO, NE, ND, SD,
WI, Western OH

WESTERN

6550 Katella Avenue
Cypress, CA 90630
714-895-7438

Covers:

AK, AZ, CA, CO, ID,
MT, NV, NM, OR, UT,
WA, WY

SOUTHERN

1854 Shackie-Ford Court,
Suite 105
Norcross, GA 30093
404-925-6860

Covers:

AL, AR, FL, GA, LA,
MS, NC, SC, TN, TX,
OK

Consumers requiring product information or operating assistance with a consumer product should contact:

CONSUMER AFFAIRS DEPARTMENT 2F-3
50 Meadowland Parkway, Secaucus, N.J. 07094 (201) 348-9090

Service in Puerto Rico

MATSUSHITA ELECTRIC OF PUERTO RICO, INC.

Panasonic Sales Company/Factory Servicenter

San Gabriel Industrial Park 65th Infantry Avenue KM 9.5
Carolina, Puerto Rico 00630 809-750-5135

Service in the Continental U.S.A.... Factory Servicenters

1575 Northside Drive
Suite 325
Atlanta, GA 30318
(404) 351-8978

2250 Cabot Blvd., West
Langhorne, PA 19047
215-741-0676

MATSUSHITA SERVICES COMPANY

Division of Matsushita Electric Corporation of America
50 Meadowland Parkway, Secaucus,
New Jersey 07094

13535 Marquaret Ave.,
Santa Fe Springs, CA 90670
213-921-8248
(mail-in service only)

Panasonic

Phone Number Directory

▶ TELEPHONE NUMBER ◀

	TEL NO.	NOTE
1		
2		
3		

▶ EXTENSION NUMBER ◀

No.	NAME	NOTE	No.	NAME	NOTE
11			15		
12			16		
13			17		
14			18		

▶ SPEED CALLING ◀

CODE	NAME	TEL NO.	CODE	NAME	TEL NO.
00			16		
01			17		
02			18		
03			19		
04			20		
05			21		
06			22		
07			23		
08			24		
09			25		
10			26		
11			27		
12			28		
13			29		
14			30		
15			31		

Panasonic

▶ SPEED CALLING ◀

CODE	NAME	TEL NO.	CODE	NAME	TEL NO.
32			66		
33			67		
34			68		
35			69		
36			70		
37			71		
38			72		
39			73		
40			74		
41			75		
42			76		
43			77		
44			78		
45			79		
46			80		
47			81		
48			82		
49			83		
50			84		
51			85		
52			86		
53			87		
54			88		
55			89		
56			90		
57			91		
58			92		
59			93		
60			94		
61			95		
62			96		
63			97		
64			98		
65			99		

PROGRAMMING TABLE (cont.)

TO SET	PROGRAM ADDRESS	STEPS REQUIRED TO CHANGE PROGRAM																																																												
Preferred Line Assignment	[15]	<p>[NEXT] [NEXT] [SELECT] [MEMORY] [END] ----- (none) / CO 1 / CO 2 / CO 3 ----- until the desired extension number appears</p> <table border="1" style="width: 100%; border-collapse: collapse;"> <thead> <tr> <th style="width: 20%;"></th> <th style="width: 15%;">Default</th> <th colspan="8" style="text-align: center;">To make program change</th> </tr> <tr> <th>Extensions</th> <td>all extensions</td> <td>11</td><td>12</td><td>13</td><td>14</td><td>15</td><td>16</td><td>17</td><td>18</td> </tr> </thead> <tbody> <tr> <td>. . . . (none)</td> <td style="text-align: center;">x</td> <td></td><td></td><td></td><td></td><td></td><td></td><td></td><td></td> </tr> <tr> <td>CO1</td> <td></td> <td></td><td></td><td></td><td></td><td></td><td></td><td></td><td></td> </tr> <tr> <td>CO2</td> <td></td> <td></td><td></td><td></td><td></td><td></td><td></td><td></td><td></td> </tr> <tr> <td>CO3</td> <td></td> <td></td><td></td><td></td><td></td><td></td><td></td><td></td><td></td> </tr> </tbody> </table>		Default	To make program change								Extensions	all extensions	11	12	13	14	15	16	17	18 (none)	x									CO1										CO2										CO3									
	Default	To make program change																																																												
Extensions	all extensions	11	12	13	14	15	16	17	18																																																					
. . . . (none)	x																																																													
CO1																																																														
CO2																																																														
CO3																																																														
Programmable Call Waiting	[16]	<p>[NEXT] [NEXT] [SELECT] [MEMORY] [END] ----- ENABLE / DISABLE ----- until the desired extension number appears</p> <table border="1" style="width: 100%; border-collapse: collapse;"> <thead> <tr> <th style="width: 20%;"></th> <th style="width: 15%;">Default</th> <th colspan="8" style="text-align: center;">To make program change</th> </tr> <tr> <th>Extensions</th> <td>all extensions</td> <td>11</td><td>12</td><td>13</td><td>14</td><td>15</td><td>16</td><td>17</td><td>18</td> </tr> </thead> <tbody> <tr> <td>Disable</td> <td style="text-align: center;">x</td> <td></td><td></td><td></td><td></td><td></td><td></td><td></td><td></td> </tr> <tr> <td>Enable</td> <td></td> <td></td><td></td><td></td><td></td><td></td><td></td><td></td><td></td> </tr> </tbody> </table>		Default	To make program change								Extensions	all extensions	11	12	13	14	15	16	17	18	Disable	x									Enable																													
	Default	To make program change																																																												
Extensions	all extensions	11	12	13	14	15	16	17	18																																																					
Disable	x																																																													
Enable																																																														
Duration Time Count Start Mode	[17]	<p>[NEXT] [SELECT] [MEMORY] [END] ----- INSTANTLY / 5S AFTER DIAL / 10S AFTER DIAL</p> <table border="1" style="width: 100%; border-collapse: collapse;"> <thead> <tr> <th style="width: 20%;"></th> <th style="width: 15%;">Default</th> <th colspan="3" style="text-align: center;">To make program change</th> </tr> </thead> <tbody> <tr> <td>Instantly</td> <td></td> <td></td><td></td><td></td> </tr> <tr> <td>5S after dial</td> <td style="text-align: center;">x</td> <td></td><td></td><td></td> </tr> <tr> <td>10S after dial</td> <td></td> <td></td><td></td><td></td> </tr> </tbody> </table>		Default	To make program change			Instantly					5S after dial	x				10S after dial																																												
	Default	To make program change																																																												
Instantly																																																														
5S after dial	x																																																													
10S after dial																																																														
Hookswitch Flash Timing	[18]	<p>[NEXT] [NEXT] [SELECT] [MEMORY] [END] ----- 300 MS / 600 MS / 900 MS ----- until the desired CO number appears</p> <table border="1" style="width: 100%; border-collapse: collapse;"> <thead> <tr> <th style="width: 20%;"></th> <th style="width: 15%;">Default</th> <th colspan="3" style="text-align: center;">To make program change</th> </tr> </thead> <tbody> <tr> <td>CO(s)</td> <td>all CO's</td> <td>1</td><td>2</td><td>3</td> </tr> <tr> <td>300 msec</td> <td></td> <td></td><td></td><td></td> </tr> <tr> <td>600 msec</td> <td style="text-align: center;">x</td> <td></td><td></td><td></td> </tr> <tr> <td>900 msec</td> <td></td> <td></td><td></td><td></td> </tr> </tbody> </table>		Default	To make program change			CO(s)	all CO's	1	2	3	300 msec					600 msec	x				900 msec																																							
	Default	To make program change																																																												
CO(s)	all CO's	1	2	3																																																										
300 msec																																																														
600 msec	x																																																													
900 msec																																																														
Disconnect Time	[19]	<p>[NEXT] [NEXT] [SELECT] [MEMORY] [END] ----- 1.5 SEC / 4.0 SEC ----- until the desired CO number appears</p> <table border="1" style="width: 100%; border-collapse: collapse;"> <thead> <tr> <th style="width: 20%;"></th> <th style="width: 15%;">Default</th> <th colspan="3" style="text-align: center;">To make program change</th> </tr> </thead> <tbody> <tr> <td>CO(s)</td> <td>all CO's</td> <td>1</td><td>2</td><td>3</td> </tr> <tr> <td>1.5 sec</td> <td style="text-align: center;">x</td> <td></td><td></td><td></td> </tr> <tr> <td>4.0 sec</td> <td></td> <td></td><td></td><td></td> </tr> </tbody> </table>		Default	To make program change			CO(s)	all CO's	1	2	3	1.5 sec	x				4.0 sec																																												
	Default	To make program change																																																												
CO(s)	all CO's	1	2	3																																																										
1.5 sec	x																																																													
4.0 sec																																																														
Calling Party Control (CPC) Signal	[20]	<p>[NEXT] [NEXT] [SELECT] [MEMORY] [END] ----- ENABLE / DISABLE ----- until the desired CO number appears</p> <table border="1" style="width: 100%; border-collapse: collapse;"> <thead> <tr> <th style="width: 20%;"></th> <th style="width: 15%;">Default</th> <th colspan="3" style="text-align: center;">To make program change</th> </tr> </thead> <tbody> <tr> <td>CO(s)</td> <td>all CO's</td> <td>1</td><td>2</td><td>3</td> </tr> <tr> <td>Enable</td> <td style="text-align: center;">x</td> <td></td><td></td><td></td> </tr> <tr> <td>Disable</td> <td></td> <td></td><td></td><td></td> </tr> </tbody> </table>		Default	To make program change			CO(s)	all CO's	1	2	3	Enable	x				Disable																																												
	Default	To make program change																																																												
CO(s)	all CO's	1	2	3																																																										
Enable	x																																																													
Disable																																																														
Intercom Alerting Mode	[21]	<p>[NEXT] [NEXT] [SELECT] [MEMORY] [END] ----- TONE CALL / VOICE CALL ----- until the desired extension number appears</p> <table border="1" style="width: 100%; border-collapse: collapse;"> <thead> <tr> <th style="width: 20%;"></th> <th style="width: 15%;">Default</th> <th colspan="8" style="text-align: center;">To make program change</th> </tr> <tr> <th>Extensions</th> <td>all extensions</td> <td>11</td><td>12</td><td>13</td><td>14</td><td>15</td><td>16</td><td>17</td><td>18</td> </tr> </thead> <tbody> <tr> <td>Tone call</td> <td style="text-align: center;">x</td> <td></td><td></td><td></td><td></td><td></td><td></td><td></td><td></td> </tr> <tr> <td>Voice call</td> <td></td> <td></td><td></td><td></td><td></td><td></td><td></td><td></td><td></td> </tr> </tbody> </table>		Default	To make program change								Extensions	all extensions	11	12	13	14	15	16	17	18	Tone call	x									Voice call																													
	Default	To make program change																																																												
Extensions	all extensions	11	12	13	14	15	16	17	18																																																					
Tone call	x																																																													
Voice call																																																														
Programmable Doorphone	[22]	<p>[NEXT] [NEXT] [SELECT] [MEMORY] [END] ----- D-PHONE 1, 2 / 1 / 2 / . . . (deny the ringing) ----- until the desired extension number appears</p> <table border="1" style="width: 100%; border-collapse: collapse;"> <thead> <tr> <th style="width: 20%;"></th> <th style="width: 15%;">Default</th> <th colspan="8" style="text-align: center;">To make program change</th> </tr> <tr> <th>Extensions</th> <td>all extensions</td> <td>11</td><td>12</td><td>13</td><td>14</td><td>15</td><td>16</td><td>17</td><td>18</td> </tr> </thead> <tbody> <tr> <td>Doorphone 1</td> <td style="text-align: center;">x</td> <td></td><td></td><td></td><td></td><td></td><td></td><td></td><td></td> </tr> <tr> <td>Doorphone 2</td> <td style="text-align: center;">x</td> <td></td><td></td><td></td><td></td><td></td><td></td><td></td><td></td> </tr> <tr> <td>deny the ringing</td> <td></td> <td></td><td></td><td></td><td></td><td></td><td></td><td></td><td></td> </tr> </tbody> </table>		Default	To make program change								Extensions	all extensions	11	12	13	14	15	16	17	18	Doorphone 1	x									Doorphone 2	x									deny the ringing																			
	Default	To make program change																																																												
Extensions	all extensions	11	12	13	14	15	16	17	18																																																					
Doorphone 1	x																																																													
Doorphone 2	x																																																													
deny the ringing																																																														

TO SET	PROGRAM ADDRESS	STEPS REQUIRED TO CHANGE PROGRAM																																																		
Dial Call Pickup Group Assignment	[23]	<p>[NEXT] [NEXT] [SELECT] [MEMORY] [END] ----- PICKUP-G:1/2/1, 2/ • • • (out of the group) ----- until the desired extension number appears</p> <table border="1"> <thead> <tr> <th></th> <th>Default</th> <th colspan="8">To make program change</th> </tr> <tr> <th>Extensions</th> <td>all extensions</td> <td>11</td> <td>12</td> <td>13</td> <td>14</td> <td>15</td> <td>16</td> <td>17</td> <td>18</td> </tr> </thead> <tbody> <tr> <td>Pickup Group 1</td> <td>x</td> <td></td> <td></td> <td></td> <td></td> <td></td> <td></td> <td></td> <td></td> </tr> <tr> <td>Pickup Group 2</td> <td></td> <td></td> <td></td> <td></td> <td></td> <td></td> <td></td> <td></td> <td></td> </tr> <tr> <td>out of the group</td> <td></td> <td></td> <td></td> <td></td> <td></td> <td></td> <td></td> <td></td> <td></td> </tr> </tbody> </table>		Default	To make program change								Extensions	all extensions	11	12	13	14	15	16	17	18	Pickup Group 1	x									Pickup Group 2										out of the group									
	Default	To make program change																																																		
Extensions	all extensions	11	12	13	14	15	16	17	18																																											
Pickup Group 1	x																																																			
Pickup Group 2																																																				
out of the group																																																				
Busy Tone Selection	[24]	<p>[NEXT] [SELECT] [MEMORY] [END] ----- TONE 1/2</p> <table border="1"> <thead> <tr> <th></th> <th>Default</th> <th colspan="2">To make program change</th> </tr> </thead> <tbody> <tr> <td>Tone 1</td> <td>x</td> <td></td> <td></td> </tr> <tr> <td>Tone 2</td> <td></td> <td></td> <td></td> </tr> </tbody> </table>		Default	To make program change		Tone 1	x			Tone 2																																									
	Default	To make program change																																																		
Tone 1	x																																																			
Tone 2																																																				
Hold Time Reminder	[25]	<p>[NEXT] [SELECT] [MEMORY] [END] ----- 1 MIN/2 MIN...../9 MIN</p> <table border="1"> <thead> <tr> <th></th> <th colspan="9">minutes</th> </tr> <tr> <th></th> <th>1</th> <th>2</th> <th>3</th> <th>4</th> <th>5</th> <th>6</th> <th>7</th> <th>8</th> <th>9</th> </tr> </thead> <tbody> <tr> <td>Default</td> <td></td> <td></td> <td>x</td> <td></td> <td></td> <td></td> <td></td> <td></td> <td></td> </tr> <tr> <td>To make program change</td> <td></td> <td></td> <td></td> <td></td> <td></td> <td></td> <td></td> <td></td> <td></td> </tr> </tbody> </table>		minutes										1	2	3	4	5	6	7	8	9	Default			x							To make program change																			
	minutes																																																			
	1	2	3	4	5	6	7	8	9																																											
Default			x																																																	
To make program change																																																				
Hold Recall Time Set	[26]	<p>[NEXT] [SELECT] [MEMORY] [END] ----- 30 SEC/1 MIN/1.5 MIN/2 MIN/DISABLE</p> <table border="1"> <thead> <tr> <th></th> <th>30 seconds</th> <th>1 minute</th> <th>1 minute 30 seconds</th> <th>2 minutes</th> <th>disable</th> </tr> </thead> <tbody> <tr> <td>Default</td> <td>x</td> <td></td> <td></td> <td></td> <td></td> </tr> <tr> <td>To make program change</td> <td></td> <td></td> <td></td> <td></td> <td></td> </tr> </tbody> </table>		30 seconds	1 minute	1 minute 30 seconds	2 minutes	disable	Default	x					To make program change																																					
	30 seconds	1 minute	1 minute 30 seconds	2 minutes	disable																																															
Default	x																																																			
To make program change																																																				
Programmable External Paging Access Tone	[27]	<p>[NEXT] [SELECT] [MEMORY] [END] ----- ENABLE/DISABLE</p> <table border="1"> <thead> <tr> <th></th> <th>Default</th> <th colspan="2">To make program change</th> </tr> </thead> <tbody> <tr> <td>Enable</td> <td>x</td> <td></td> <td></td> </tr> <tr> <td>Disable</td> <td></td> <td></td> <td></td> </tr> </tbody> </table>		Default	To make program change		Enable	x			Disable																																									
	Default	To make program change																																																		
Enable	x																																																			
Disable																																																				
DTMF Receiver Check	[28]	<p>[NEXT] [SELECT] [MEMORY] [END] ----- ENABLE/DISABLE ----- until the desired DTMF receiver appears</p> <table border="1"> <thead> <tr> <th></th> <th>Default</th> <th colspan="2">To make program change</th> </tr> </thead> <tbody> <tr> <td>DTMF receiver</td> <td>1, 2</td> <td>1</td> <td>2</td> </tr> <tr> <td>Enable</td> <td>x</td> <td></td> <td></td> </tr> <tr> <td>Disable</td> <td></td> <td></td> <td></td> </tr> </tbody> </table>		Default	To make program change		DTMF receiver	1, 2	1	2	Enable	x			Disable																																					
	Default	To make program change																																																		
DTMF receiver	1, 2	1	2																																																	
Enable	x																																																			
Disable																																																				
Programmable Toll Prefix	[29]	<p>[NEXT] [SELECT] [MEMORY] [END] ----- WITH 1/ WITHOUT 1</p> <table border="1"> <thead> <tr> <th></th> <th>Default</th> <th colspan="2">To make program change</th> </tr> </thead> <tbody> <tr> <td>With 1</td> <td>x</td> <td></td> <td></td> </tr> <tr> <td>Without 1</td> <td></td> <td></td> <td></td> </tr> </tbody> </table>		Default	To make program change		With 1	x			Without 1																																									
	Default	To make program change																																																		
With 1	x																																																			
Without 1																																																				
Programmable secret Auto Dial	[30]	<p>[NEXT] [SELECT] [MEMORY] [END] ----- NO SECRET/ SECRET</p> <table border="1"> <thead> <tr> <th></th> <th>Default</th> <th colspan="2">To make program change</th> </tr> </thead> <tbody> <tr> <td>No secret</td> <td>x</td> <td></td> <td></td> </tr> <tr> <td>Secret</td> <td></td> <td></td> <td></td> </tr> </tbody> </table>		Default	To make program change		No secret	x			Secret																																									
	Default	To make program change																																																		
No secret	x																																																			
Secret																																																				
Station Program Clear	[98]	[NEXT] [MEMORY] [END]																																																		
System Clear	[99]	[NEXT] [MEMORY] [END]																																																		