

# Panasonic

Advanced Hybrid System

## *Installation Manual*

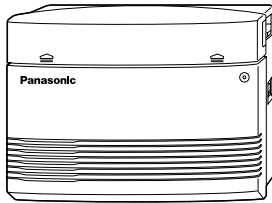

**KX-TA308**

MODEL **KX-TA616**



This manual was printed  
with soy based ink.

**Please read this manual before connecting  
the Advanced Hybrid System.**

# System Highlights

## System Capacity

|                     |                            | <KX-TA308> | <KX-TA616> |
|---------------------|----------------------------|------------|------------|
| <b>Basic System</b> | Extensions                 | 8          | 16         |
|                     | Outside (CO) lines         | 3          | 6          |
| <b>Expansion</b>    | Maximum extensions         | 24         | 24         |
|                     | Maximum outside (CO) lines | 6          | 6          |

## Special System Points

### System Expansion

This system can expand the outside (CO) lines (KX-TA308 only) and extension capacity by installing an optional card.

☞ 2-24

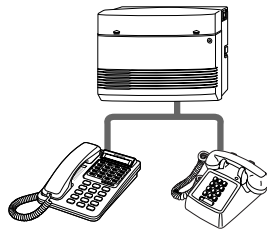

### Direct Backup Power Supply

Car batteries can be connected directly to this system as a backup power supply in the event of a power failure. This system does not need an optional battery adaptor.

☞ 2-23

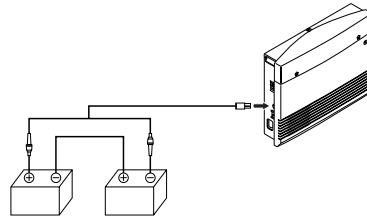

### Hybrid

This system can accept Panasonic analog proprietary telephones. Also, single line devices such as single line telephones, facsimiles and data terminals can be connected.

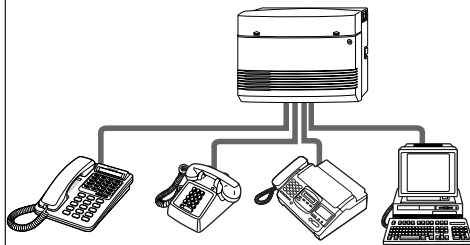

### Calling from the outside (Direct Inward System Access)

External callers can call extensions in the system. If you install an optional card, an outgoing message will greet the caller and give information about how to access an extension.

☞ 3-13

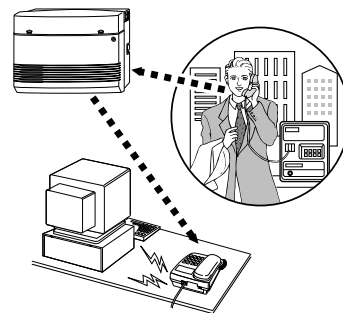

## *Precautions*

---

- Keep the unit away from heating appliances and electrical noise generating devices such as fluorescent lamps, motors and televisions. These noise sources can interfere with the performance of the Advanced Hybrid System.
- This unit should be kept free of dust, moisture, high temperature (more than 40°C) and vibration, and should not be exposed to direct sunlight.
- Never attempt to insert wires, pins, etc. into the vents or other holes of this unit.
- If there is any trouble, disconnect the unit from the telephone line. Plug the telephone directly into the telephone line. If the telephone operates properly, do not reconnect the unit to the line until the trouble has been repaired. If the telephone does not operate properly, chances are that the trouble is in the telephone system, and not in the unit.
- Do not use benzine, thinner, or the like, or any abrasive powder to clean the cabinet. Wipe it with a soft cloth.

### **WARNING**

THIS UNIT MAY ONLY BE INSTALLED AND SERVED BY QUALIFIED SERVICE PERSONNEL.

WHEN A FAILURE OCCURS WHICH RESULTS IN THE INTERNAL PARTS BECOMING ACCESSIBLE, DISCONNECT THE POWER SUPPLY CORD IMMEDIATELY AND RETURN THIS UNIT TO YOUR DEALER.

DISCONNECT THE TELECOM CONNECTION BEFORE DISCONNECTING THE POWER CONNECTION PRIOR TO RELOCATING THE EQUIPMENT, AND RECONNECT THE POWER FIRST.

THIS UNIT IS EQUIPPED WITH AN EARTHING CONTACT PLUG. FOR SAFETY REASONS THIS PLUG MUST ONLY BE CONNECTED TO AN EARTHING CONTACT SOCKET WHICH HAS BEEN INSTALLED ACCORDING TO REGULATIONS.

THE POWER SUPPLY CORD IS USED AS THE MAIN DISCONNECT DEVICE, ENSURE THAT THE SOCKET-OUTLET IS LOCATED/INSTALLED NEAR THE EQUIPMENT AND IS EASILY ACCESSIBLE.

TO PREVENT FIRE OR SHOCK HAZARD, DO NOT EXPOSE THIS PRODUCT TO RAIN OR MOISTURE.

## *Precautions*

---

For your future reference

SERIAL NO. \_\_\_\_\_ DATE OF PURCHASE \_\_\_\_\_  
(found on the bottom of the unit)

NAME OF DEALER \_\_\_\_\_

DEALER'S ADDRESS \_\_\_\_\_

**Note** • This Installation Manual does not show complete model number that indicate the country where your models should be used. The model number of your unit is found on the label affixed to the unit.

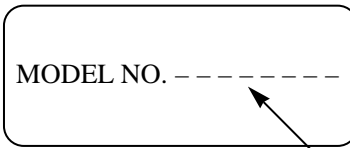

(label)

# *Introduction*

---

## *Structure of the Manual*

This manual consists of the following sections:

### **Section 1. Basic System Construction**

Provides general information on the system including connection diagrams.

### **Section 2. Installation**

Contains the system installation and wiring instructions, as well as how to install the optional card.

### **Section 3. Features**

Describes the optional and programmable features in alphabetical order. It also provides information about the conditions, required System Programming, connection references, related features and operating instructions references for every feature.

### **Section 4. System Programming**

Describes the steps required to assign features to extensions or to the system.

### **Section 5. Appendix**

Provides specifications and the default values of the System Programming.

### **Section 6. Troubleshooting**

Provides information for system and telephone troubleshooting.

### **Section 7. Programming Tables**

Provides programming tables for user-programmed data.

## *Description of the Symbols Mainly Used in this manual*



Additional information and conditions.



The feature or program references.

# Contents

---

## Section 1 Basic System Construction

### Section 2 Installation

|      |   |      |
|------|---|------|
| 2.1  | Before Installation .....   | 2-2  |
| 2.2  | Unpacking .....   | 2-4  |
| 2.3  | Names and Locations .....   | 2-4  |
| 2.4  | Wall Mounting .....   | 2-5  |
| 2.5  | Frame Ground Connection .....   | 2-6  |
| 2.6  | Opening the Top Front Cover .....   | 2-6  |
| 2.7  | Outside (CO) Line Connection .....  | 2-7  |
| 2.8  | Extension Connection .....  | 2-9  |
| 2.9  | External Pager (Paging Equipment) Connection.....   | 2-10 |
| 2.10 | External Music Connection.....  | 2-11 |
| 2.11 | Paralleled Telephone Connection .....   | 2-12 |
| 2.12 | Polarity Sensitive Telephone Connection.....  | 2-13 |
| 2.13 | Printer and PC Connection.....  | 2-14 |
| 2.14 | Location of Optional Cards.....   | 2-17 |
| 2.15 | OGM/FAX Detection Card Installation.....  | 2-17 |
| 2.16 | Doorphone and Door Opener Connection .....  | 2-19 |
| 2.17 | Backup Batteries Connection.....  | 2-23 |
| 2.18 | Installing a 3-CO Line & 8 Ext Expansion Card (KX-TA30877)<br>and 8 SLT Extn. Expansion Card (KX-TA30874) ..... | 2-24 |
| 2.19 | Auxiliary Connection for Power Failure Transfer.....  | 2-29 |
| 2.20 | Securing the Cords.....   | 2-29 |
| 2.21 | Closing the Front Cover .....   | 2-30 |
| 2.22 | Starting the System for the First Time .....  | 2-31 |
| 2.23 | System Restart.....   | 2-33 |
| 2.24 | System Data Clear.....  | 2-34 |

### Section 3 Features

|   |   |     |
|---|---|-----|
| A | Absent Message Capability .....                           | 3-2 |
|   | Account Code Entry .....                                  | 3-2 |
|   | Alternate Calling – Ring/Voice (Voice to Ring only) ..... | 3-3 |
|   | Automatic Callback Busy (Camp-On) .....                   | 3-3 |
|   | Automatic Outside (CO) Line Access Number.....            | 3-4 |
| B | Busy Station Signaling (BSS) .....                        | 3-4 |
| C | Call Forwarding.....                                      | 3-5 |
|   | Calling Party Control (CPC) Signal Detection .....        | 3-5 |
|   | Call Park .....   | 3-6 |
|   | Call Pickup .....   | 3-7 |
|   | Call Splitting.....                                       | 3-7 |
|   | Call Transfer – to Extension.....                         | 3-8 |
|   | Call Transfer – to Outside (CO) Line .....                | 3-8 |
|   | Call Waiting.....   | 3-9 |

# Contents

---

|          |  |      |
|----------|--|------|
| <b>C</b> | Conference (3-Party) .....   | 3-10 |
|          | Conference (5-Party) .....   | 3-11 |
| <b>D</b> | Data Line Security .....   | 3-11 |
|          | Date and Time Setting .....  | 3-12 |
|          | Direct In Line (DIL) .....   | 3-12 |
|          | Direct Inward System Access (DISA).....  | 3-13 |
|          | Display Contrast Adjustment<br>(KX-T7330/KX-T7030/KX-T7130/KX-T7033 only).....   | 3-20 |
|          | Distinctive Dial Tone.....   | 3-20 |
|          | Do Not Disturb (DND).....  | 3-21 |
|          | Door Opener .....  | 3-21 |
|          | Doorphone Call .....   | 3-22 |
|          | DSS Console.....   | 3-23 |
| <b>E</b> | Emergency Call .....   | 3-23 |
|          | Executive Busy Override.....   | 3-24 |
|          | Extension Button Confirmation<br>(KX-T7330/KX-T7030/KX-T7130/KX-T7033 only)..... | 3-24 |
|          | Extension Group.....   | 3-25 |
|          | Extension Password / System Password .....                                       | 3-25 |
|          | External Feature Access .....  | 3-26 |
| <b>F</b> | Flash.....   | 3-26 |
|          | Flexible Buttons.....  | 3-27 |
| <b>H</b> | Handset/Headset Selection<br>(KX-T7330/KX-T7030/KX-T7130/KX-T7033 only).....     | 3-28 |
|          | Handsfree Answerback .....   | 3-28 |
|          | Handsfree Operation.....   | 3-28 |
|          | Hold .....   | 3-29 |
|          | Hookswitch Flash .....   | 3-30 |
|          | Host PBX Access.....   | 3-30 |
| <b>I</b> | Intercept Routing .....  | 3-31 |
|          | Intercom Calling .....   | 3-31 |
| <b>L</b> | Language Selection .....   | 3-32 |
|          | Limited Call Duration .....  | 3-32 |
|          | Line Access Buttons .....  | 3-33 |
|          | Log-In/Log-Out .....   | 3-34 |
| <b>M</b> | Message Waiting.....   | 3-34 |
|          | Microphone Mute .....  | 3-35 |
|          | Music on Hold / Background Music (BGM) .....                                     | 3-35 |
| <b>O</b> | One-Touch Dialing .....  | 3-35 |
|          | Operator / Manager Extension .....   | 3-36 |
|          | Operator Call .....  | 3-36 |
|          | Outgoing Message (OGM).....  | 3-37 |
|          | Outside Calling.....   | 3-40 |
|          | Outside (CO) Line Ringing Selection .....  | 3-41 |

# Contents

---

|          |   |      |
|----------|---|------|
| <b>P</b> | Paging .....  | 3-41 |
|          | Paralleled Telephone Connection .....   | 3-42 |
|          | Personal Speed Dialing .....  | 3-42 |
|          | Pickup Dialing .....  | 3-43 |
|          | Polarity Reverse Detection .....  | 3-43 |
|          | Power Failure Transfer .....  | 3-44 |
|          | Preferred Line Assignment — Incoming .....  | 3-44 |
|          | Preferred Line Assignment — Outgoing.....   | 3-45 |
|          | Proprietary Telephone setting Data Default Set.....                                   | 3-45 |
|          | Pulse to Tone Conversion.....   | 3-46 |
| <b>R</b> | Receiving Calls.....  | 3-46 |
|          | Redial .....  | 3-46 |
|          | Ringing Pattern Selection .....   | 3-47 |
|          | Room Monitor .....  | 3-48 |
| <b>S</b> | Secret Dialing .....  | 3-48 |
|          | Self-Extension Number Confirmation<br>(KX-T7330/KX-T7030/KX-T7130/KX-T7033 only)..... | 3-49 |
|          | Station Feature Clear .....   | 3-49 |
|          | Station Hunting.....  | 3-50 |
|          | Station Lock.....   | 3-51 |
|          | Station Message Detail Recording (SMDR) .....   | 3-52 |
|          | System Data Default Set .....   | 3-53 |
|          | System Speed Dialing .....  | 3-54 |
| <b>T</b> | Timed Reminder .....  | 3-54 |
|          | Time (Day/Night/Lunch) Service.....   | 3-55 |
|          | Toll Restriction .....  | 3-56 |
|          | Toll Restriction for System Speed Dialing.....  | 3-58 |
|          | Toll Restriction Override by Extension Password .....                                 | 3-59 |
|          | Toll Restriction – Station Lock Boundary Class.....                                   | 3-60 |
| <b>U</b> | Uniform Call Distribution (UCD) .....   | 3-60 |
| <b>V</b> | Voice Mail Integration.....   | 3-64 |
|          | Volume Control .....  | 3-67 |
| <b>W</b> | Walking COS .....   | 3-67 |

## **Section 4 System Programming**

|            |  |            |
|------------|--|------------|
| <b>4.1</b> | <b>Before System Programming .....</b>                   | <b>4-2</b> |
| <b>4.2</b> | <b>System Programming.....</b>                           | <b>4-5</b> |
|            | [000] Date and Time Setting.....                         | 4-5        |
|            | [001] System Speed Dialing Entry .....                   | 4-5        |
|            | [002] System Password.....                               | 4-6        |
|            | [003] DSS Console Port Assignment.....                   | 4-7        |
|            | [004] Paired Telephone Assignment for DSS Console .....  | 4-7        |
|            | [005] One-Touch Transfer Using a DSS Button .....        | 4-8        |
|            | [006] Time (Day/Night/Lunch) Service Changing Mode ..... | 4-8        |

# Contents

---

|       |  |      |
|-------|--|------|
| [007] | Time (Day/Night/Lunch) Service Start Time .....              | 4-9  |
| [008] | Operator Assignment .....                                    | 4-10 |
| [009] | Extension Number Assignment .....                            | 4-10 |
| [010] | LCD Time Display Selection .....                             | 4-11 |
| [100] | Hunting Group Set .....                                      | 4-12 |
| [101] | Hunting Type .....   | 4-12 |
| [102] | Voice Mail Port .....  | 4-13 |
| [103] | DTMF Integration .....                                       | 4-13 |
| [104] | Hold Mode Selection .....                                    | 4-15 |
| [105] | Conference Tone .....  | 4-15 |
| [106] | External Paging Access Tone .....                            | 4-16 |
| [107] | DTMF Receiver Check .....                                    | 4-16 |
| [108] | Flash Mode for a Station Locked Extension .....              | 4-16 |
| [109] | CO Indicator Assignment .....                                | 4-17 |
| [110] | Flash Key Mode .....   | 4-17 |
| [111] | Hold Music Selection .....                                   | 4-18 |
| [112] | DSS Console Indication Mode .....                            | 4-18 |
| [113] | Automatic Redial Repeat .....                                | 4-19 |
| [114] | Automatic Redial Interval Time .....                         | 4-19 |
| [115] | Extension Ringing Pattern Selection .....                    | 4-20 |
| [116] | Conference Pattern Selection .....                           | 4-20 |
| [117] | Call Pickup Tone .....                                       | 4-21 |
| [118] | Pulse Restriction .....                                      | 4-21 |
| [119] | Redialing after Pulse to Tone Conversion .....               | 4-21 |
| [120] | Bell Frequency .....   | 4-22 |
| [121] | Automatic Outside (CO) Line Access Number Selection .....    | 4-22 |
| [122] | Automatic Rotation for Outside (CO) Line Access .....        | 4-22 |
| [123] | Break Ratio .....  | 4-23 |
| [124] | SLT Ringing Mode Selection .....                             | 4-23 |
| [125] | Toll Restriction Check for * and # .....                     | 4-23 |
| [200] | Hold Recall Time .....                                       | 4-24 |
| [201] | Transfer Recall Time .....                                   | 4-24 |
| [202] | Call Forwarding Start Time .....                             | 4-24 |
| [203] | Pickup Dial Delay Time .....                                 | 4-25 |
| [204] | Call Duration Count Start Time .....                         | 4-25 |
| [205] | Outside-to-Outside (CO-to-CO) Line Duration Time Limit ..... | 4-26 |
| [206] | Dialing Start Time .....                                     | 4-26 |
| [207] | Hookswitch Flash Timing Range Selection .....                | 4-27 |
| [208] | Interdigit Time .....  | 4-27 |
| [210] | DTMF Time .....  | 4-28 |
| [211] | No Dial Disconnection .....                                  | 4-28 |
| [212] | Outside (CO) Line Duration Time Limit .....                  | 4-29 |
| [213] | Bell Off Detection .....                                     | 4-29 |
| [300] | Carrier Code Assignment .....                                | 4-30 |

# Contents

---

|  |      |
|--|------|
| [301] Toll Restriction — System Speed Dialing Boundary Class ..            | 4-30 |
| [302]–[305] Toll Restriction — Classes 2 through 5 Denied Codes ..         | 4-31 |
| [306] Toll Restriction — Exception Codes .....                             | 4-32 |
| [309] Emergency Dial Number Set .....                                      | 4-32 |
| [310] Account Codes .....  | 4-33 |
| [311] Automatic Pause Insertion Codes .....                                | 4-33 |
| [312] Toll Restriction — Station Lock Boundary Class .....                 | 4-34 |
| [400] Outside (CO) Line Connection Assignment .....                        | 4-35 |
| [401] Dial Mode .....  | 4-35 |
| [402] Pulse Speed Selection .....  | 4-36 |
| [403] Host PBX Access Codes .....  | 4-36 |
| [404] Outside (CO) Line Group Assignment .....                             | 4-37 |
| [405]–[407] Flexible Outward Dialing Assignment<br>— Day/Night/Lunch ..... | 4-38 |
| [408]–[410] Flexible Ringing Assignment — Day/Night/Lunch ....             | 4-39 |
| [411]–[413] Delayed Ringing Assignment — Day/Night/Lunch ....              | 4-40 |
| [414]–[416] Outside (CO) Line Mode — Day/Night/Lunch .....                 | 4-41 |
| [417] Pause Time .....   | 4-42 |
| [418] Flash Time .....   | 4-43 |
| [419] Automatic Designated Outside (CO) Line Access .....                  | 4-43 |
| [420] Calling Party Control (CPC) Signal .....                             | 4-44 |
| [421] CPC Detection for Outgoing Calls .....                               | 4-45 |
| [422] Disconnect Time .....  | 4-45 |
| [423] Outside (CO) Line Ringing Pattern Selection .....                    | 4-46 |
| [424] Reverse (Polarity) Circuit Assignment .....                          | 4-47 |
| [500] DISA Incoming Dialing Mode Selection .....                           | 4-48 |
| [501] DISA Built-in Auto Attendant .....                                   | 4-49 |
| [502] OGM Mode Selection .....   | 4-50 |
| [503] FAX Connection .....   | 4-51 |
| [504] DISA Delayed Answer Time .....                                       | 4-51 |
| [505] DISA Waiting Time after OGM .....                                    | 4-51 |
| [506] DISA Busy Mode .....   | 4-52 |
| [507] DISA Intercept Mode .....  | 4-52 |
| [508] DISA Ringing Time before Intercept .....                             | 4-53 |
| [509] DISA Ringing Time after Intercept .....                              | 4-53 |
| [510] DISA No Dial Mode .....  | 4-54 |
| [511] DISA Security Type .....   | 4-54 |
| [512] DISA Security Codes .....  | 4-55 |
| [513] Cyclic Tone Detection .....  | 4-55 |
| [514] Fax Tone Detection .....   | 4-56 |
| [515] Intercept Time for Internal DISA .....                               | 4-56 |
| [516] DISA Incoming Assignment .....                                       | 4-57 |
| [517] DISA AA Wait Time .....  | 4-57 |
| [518] DISA Tone Selection after the Security Code .....                    | 4-58 |

# Contents

---

|             |   |      |
|-------------|---|------|
| [519]       | DISA OGM Mute Time .....                                | 4-58 |
| [520]       | UCD Group .....   | 4-59 |
| [521]       | UCD Busy Waiting Time .....                             | 4-59 |
| [522]       | UCD OGM Message Interval Time .....                     | 4-59 |
| [523]       | UCD Busy Mode .....                                     | 4-60 |
| [524]       | UCD Intercept Mode .....                                | 4-60 |
| [525]       | UCD Ringing Time before Intercept .....                 | 4-61 |
| [526]       | UCD Ringing Time after Intercept .....                  | 4-61 |
| [600]       | Extension Group Assignment .....                        | 4-62 |
| [601]–[603] | TRS – Class of Service Assignment                       |      |
|             | — Day/Night/Lunch .....                                 | 4-62 |
| [604]       | Extension Name Setting .....                            | 4-63 |
| [605]       | Account Code Entry Mode .....                           | 4-64 |
| [606]       | Call Transfer to an Outside (CO) Line .....             | 4-65 |
| [607]       | Call Forwarding to an Outside (CO) Line .....           | 4-65 |
| [608]       | Executive Busy Override .....                           | 4-66 |
| [609]       | Do Not Disturb Override .....                           | 4-66 |
| [610]       | Paralleled Telephone Connection .....                   | 4-67 |
| [611]       | TAM (Telephone Answering Machine) Extension .....       | 4-67 |
| [612]       | Room Monitor Assignment .....                           | 4-68 |
| [613]       | Outside (CO) Line Duration Time Limit Selection .....   | 4-68 |
| [614]       | Internal Pulse Detection .....                          | 4-69 |
| [615]       | LCD Language Assignment .....                           | 4-70 |
| [616]       | Extension Name Setting in Russian .....                 | 4-71 |
| [700]–[702] | Doorphone Ringing Assignment — Day/Night/Lunch ..       | 4-72 |
| [703]–[705] | Door Opener Assignment — Day/Night/Lunch .....          | 4-73 |
| [706]       | Doorphone Ringing / Tone Pattern Selection .....        | 4-74 |
| [707]       | Doorphone Access Tone Selection .....                   | 4-74 |
| [708]       | Doorphone Ringing Time .....                            | 4-75 |
| [709]       | Door Opener Time .....                                  | 4-75 |
| [800]       | SMDR RS-232C Communication Parameters .....             | 4-76 |
| [801]       | SMDR Parameter .....                                    | 4-77 |
| [802]       | Incoming/Outgoing Call Selection for Printing .....     | 4-77 |
| [803]       | Secret Speed Dialing / One-Touch Dialing Printing ..... | 4-78 |
| [804]       | System Data Dump .....                                  | 4-78 |
| [805]       | SMDR Account Code Selection .....                       | 4-80 |
| [998]       | ROM Version .....                                       | 4-80 |
| [999]       | System Data Clear .....                                 | 4-81 |

# *Contents*

---

|                  |                           |     |
|------------------|---------------------------|-----|
| <b>Section 5</b> | <b>Appendix</b>           |     |
| 5.1              | Default Values .....      | 5-2 |
| 5.2              | Specifications .....      | 5-7 |
| <b>Section 6</b> | <b>Troubleshooting</b>    |     |
| 6.1              | While Installing .....    | 6-2 |
| 6.2              | While Connecting .....    | 6-3 |
| 6.3              | While Operating .....     | 6-4 |
| <b>Section 7</b> | <b>Programming Tables</b> |     |
|                  | <b>Template</b>           |     |

*Section 1*  
*Basic System Construction*

# 1 Basic System Construction

The KX-TA308 has a basic capacity of 8 extensions and 3 outside (CO) lines, and the KX-TA616 has 16 extensions and 6 outside (CO) lines. It is capable of supporting Panasonic analog proprietary telephones, and single line devices such as single line telephones, facsimiles and data terminals.

To expand its capabilities, the system can be equipped with optional components or customer-supplied peripherals such as an external speaker, external music source (e.g. a radio) and door opener.

## System Connection Diagram

### ■ KX-TA308

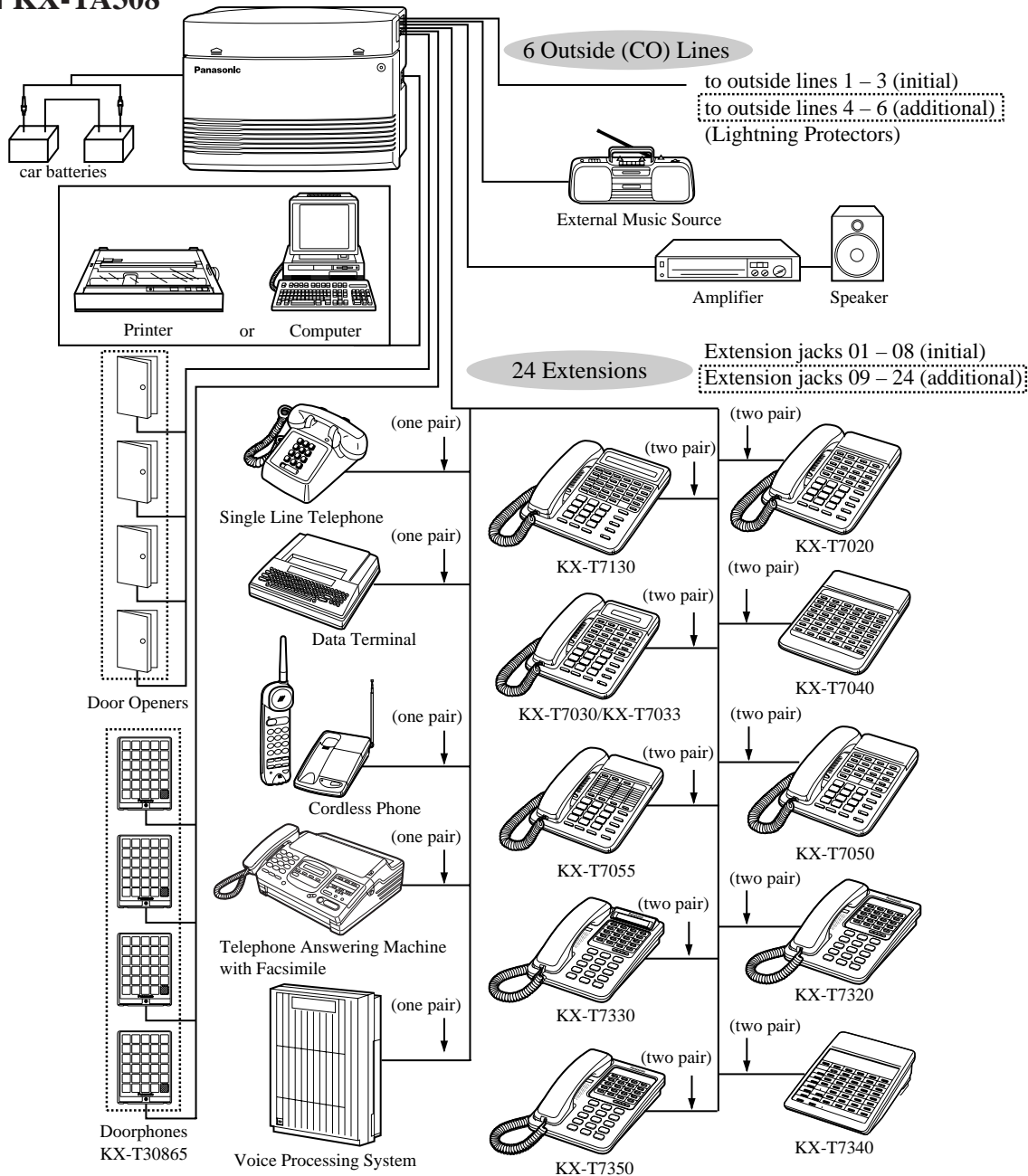

# 1 Basic System Construction

## ■ KX-TA616

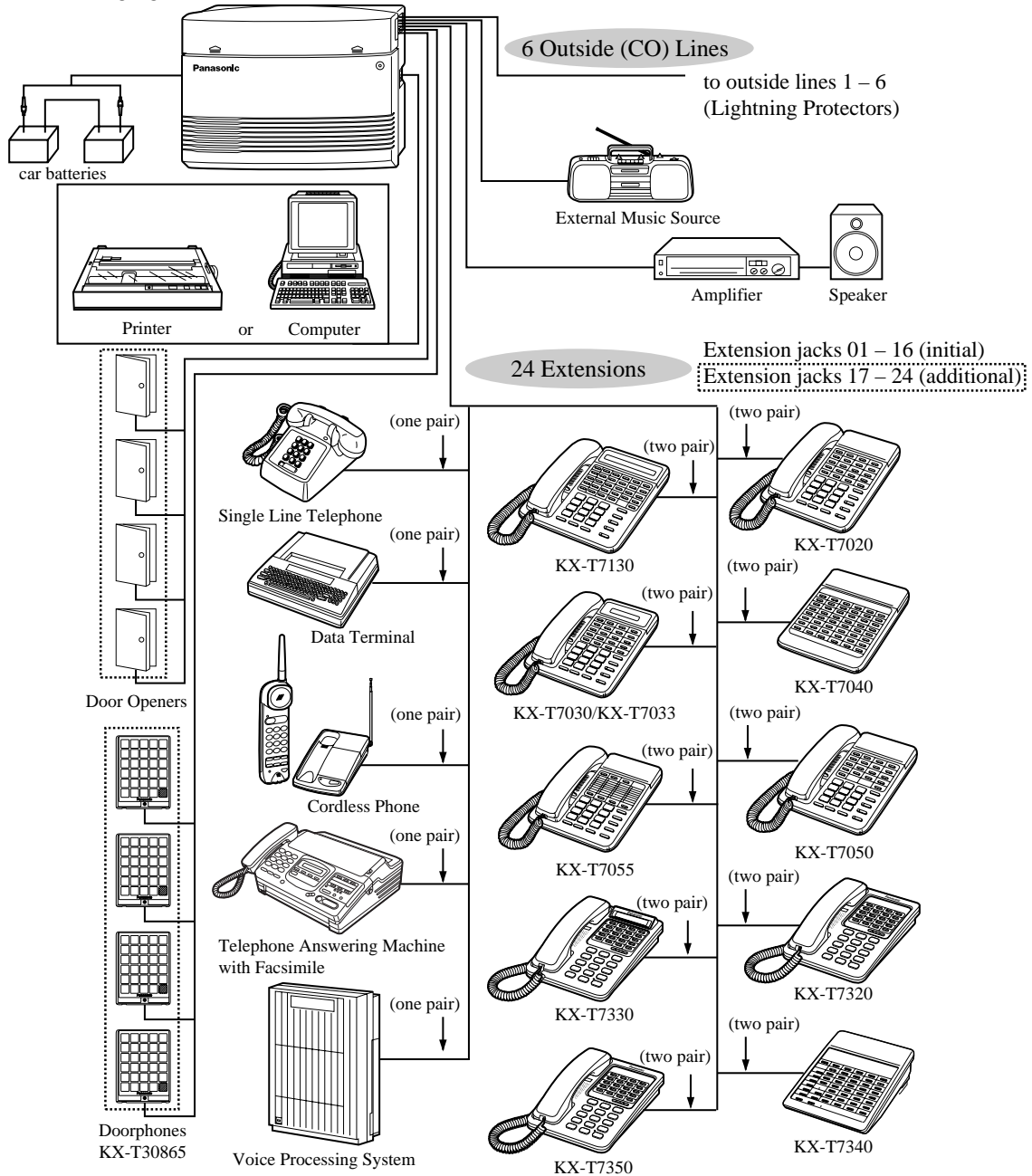

- ! We recommend connecting a display proprietary telephone at extension jack 01.
- Parallel connection of telephone is possible. (☞ 2.11, Paralleled Telephone Connection)
- A proprietary telephone cannot be connected to extension jacks 17 through 24. Only a single line telephone (SLT) can be connected.

☐ : needs optional card.



*Section 2*  
*Installation*

## 2.1 *Before Installation*

---

Please read the following notes concerning installation and connection before installing the system and terminal equipment.

### *Safety Installation Instructions*

When installing telephone wiring, basic safety precautions should always be followed to reduce the risk of fire, electric shock and injury to persons, including the following:

1. Never install telephone wiring during a lightning storm.
2. Never install telephone jacks in wet locations unless the jack is specifically designed for wet locations.
3. Never touch uninsulated telephone wires or terminals unless the telephone line has been disconnected at the network interface.
4. Use caution when installing or modifying telephone lines.

### *Installation Precautions*

This system is designed for wall mounting only. Avoid installing in the following places. (Doing so may result in malfunction, noise, or discoloration.)

1. In direct sunlight and hot, cold, or humid places. (Temperature range: 0°C – 40°C)
2. Sulfuric gases produced in areas where there are thermal springs, etc. may damage the equipment or contacts.
3. Places in which shocks or vibrations are frequent or strong.
4. Dusty places, or places where water or oil may come into contact with the system.
5. Near high-frequency generating devices such as sewing machines or electric welders.
6. On or near computers, telexes, or other office equipment, as well as microwave ovens or air conditioners. (It is preferable not to install the system in the same room with the above equipment.)
7. Install at least 1.8 m away from radios and televisions. (Both the system and Panasonic proprietary telephones)
8. Do not obstruct area around the system (for reasons of maintenance and inspection — be especially careful to allow space for cooling above and at the sides of the system).

### *Wiring Precautions*

Be sure to follow these instructions when wiring the unit:

1. Do not wire the telephone cable in parallel with an AC power source, computer, telex, etc. If the cables are run near those wires, shield the cables with metal tubing or use shielded cables and ground the shields.
2. If cables are run on the floor, use protectors to prevent the wires from being stepped on. Avoid wiring under carpets.
3. Avoid using the same power supply outlet for computers, telexes, and other office equipment. Otherwise, the system operation may be interrupted by the induction noise from such equipment.

## 2.1 Before Installation

---

4. Please use one pair telephone wire for extension connection of (telephone) equipment such as single line telephones, data terminals, answering machines, computers, voice processing systems, etc., except Panasonic proprietary telephones (e.g. KX-T7330).
5. Unplug the system during wiring. After all of the wiring is completed, plug in the system.
6. Mis-wiring may cause the system to operate improperly. Refer to Section 6.1 “While Installing” and Section 6.2 “While Connecting”.
7. If an extension does not operate properly, disconnect the telephone from the extension line and then connect again, or turn off the Power Switch of the system and then on again.
8. The system is equipped with a 3-wire grounding type plug. This is a safety feature. If you are unable to insert the plug into the outlet, contact your electrician to replace your obsolete outlet. Do not defeat the purpose of the grounding-type plug.
9. Outside (CO) lines should be installed with lightning protectors. For details, refer to Section 2.7 “Outside (CO) Line Connection”, Installing Lightning Protectors.

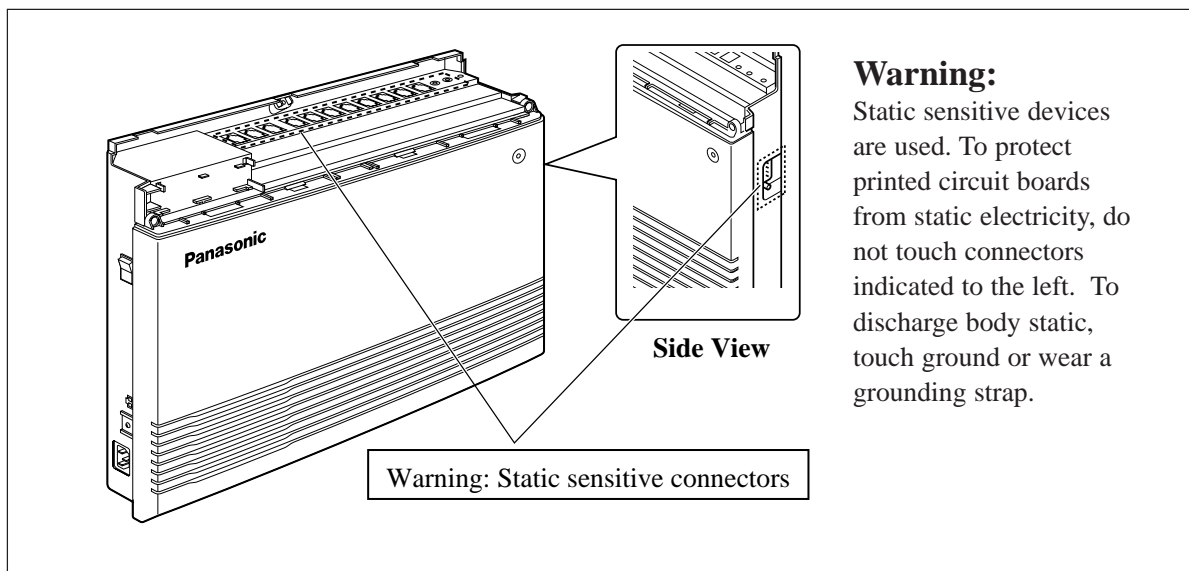

\* The illustration on this page is a KX-TA308.

## 2.2 Unpacking

Unpack the box and check the items below.

|                         |   |                        |   |
|-------------------------|---|------------------------|---|
| Main Unit               | 1 | Music Source Connector | 1 |
| AC Cord                 | 1 | Plug Adaptor           | 1 |
| Screws (Wall Mounting)  | 3 | Strap                  | 1 |
| Washers (Wall Mounting) | 3 | Rivet                  | 1 |
| Pager Connector         | 1 |                        |   |

## 2.3 Names and Locations

### ■ KX-TA308

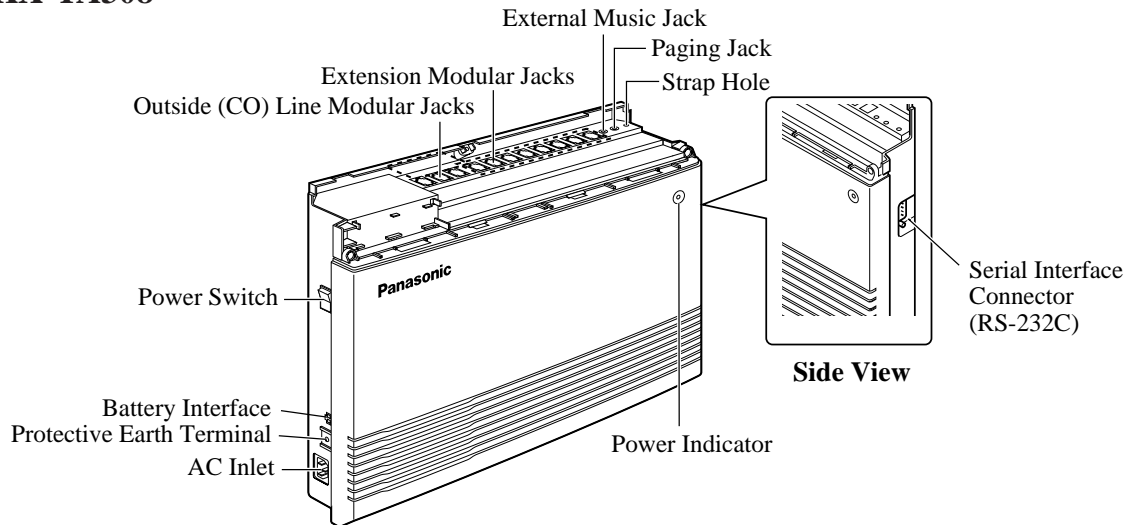

### ■ KX-TA616

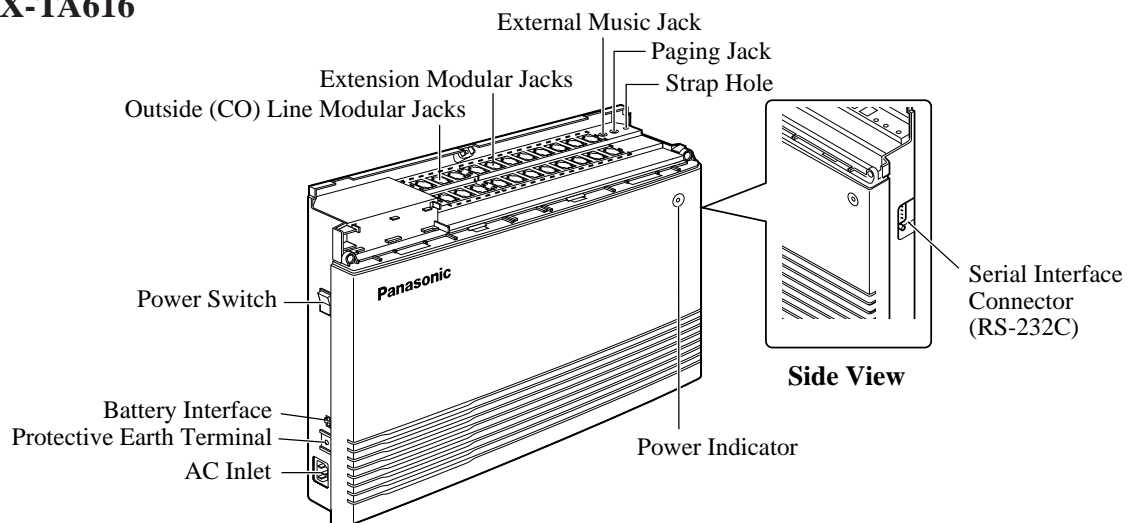

## 2.4 Wall Mounting

This set is designed for wall mounting only. The wall where the main unit is to be mounted must be able to support the weight of the main unit. If screws other than the ones supplied are used, use screws with the same diameter as the ones enclosed.

### Mounting on a Wooden Wall

1. Place the template (on the last page) on the wall to mark the screw positions.

┌

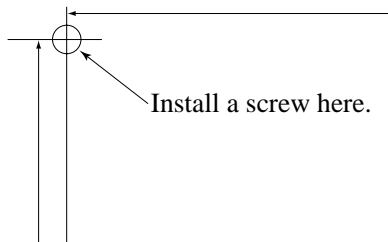

2. Install the screws (included) into the wall.

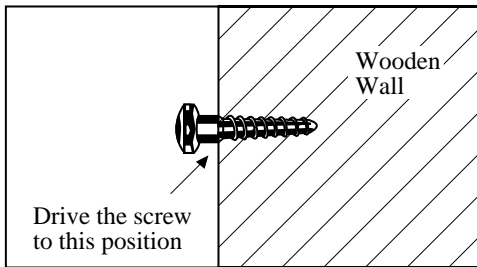

3. Hook the main unit on the screw heads.

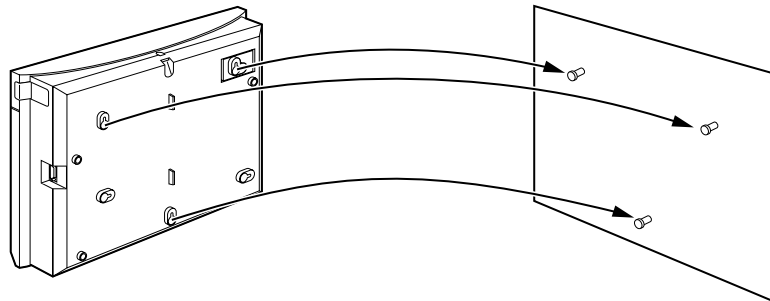

### Mounting on a Concrete or Mortar Wall

1. Place the template (on the last page) on the wall to mark the screw positions.
2. Drill holes and drive the anchor plugs (user-supplied) with a hammer, flush to the wall.

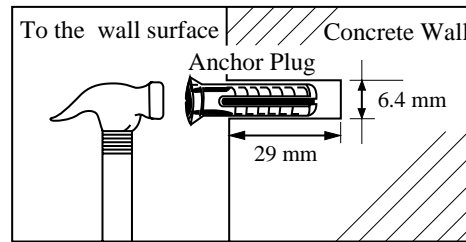

3. Install the screws (included) into the anchor plugs.

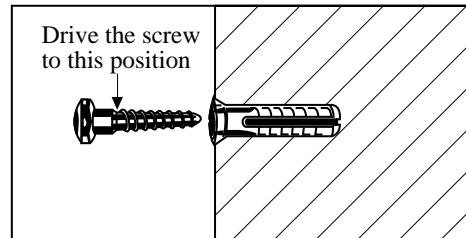

4. Hook the main unit on the screw heads.

## 2.5 *Frame Ground Connection*

---

### **IMPORTANT!!!**

Connect the frame of the main unit to the ground.

1. Loosen the screw.
2. Insert the grounding wire (user-supplied).
3. Tighten the screw.
4. Connect the grounding wire to the ground.

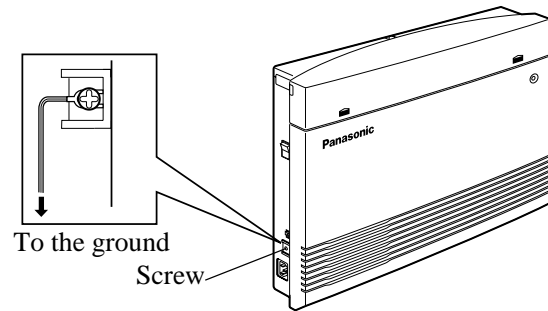

## 2.6 *Opening the Top Front Cover*

---

1. Loosen the screw.
2. Remove the top front cover.

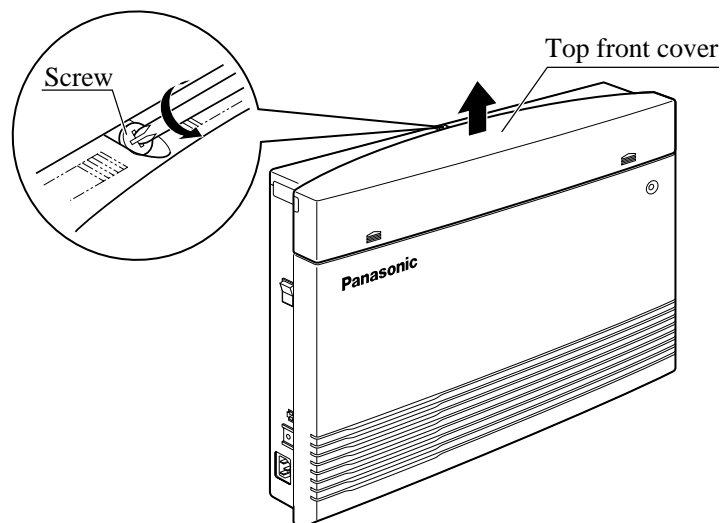

- ! • The screw cannot be removed from the cover.

## 2.7 *Outside (CO) Line Connection*

---

### *Connection*

1. Insert the modular plugs of the telephone line cords (2-conductor wiring) into the modular jacks (CO 1 through 3) on the system.
2. Connect the line cords to the terminal board or the modular jacks from the Central Office.

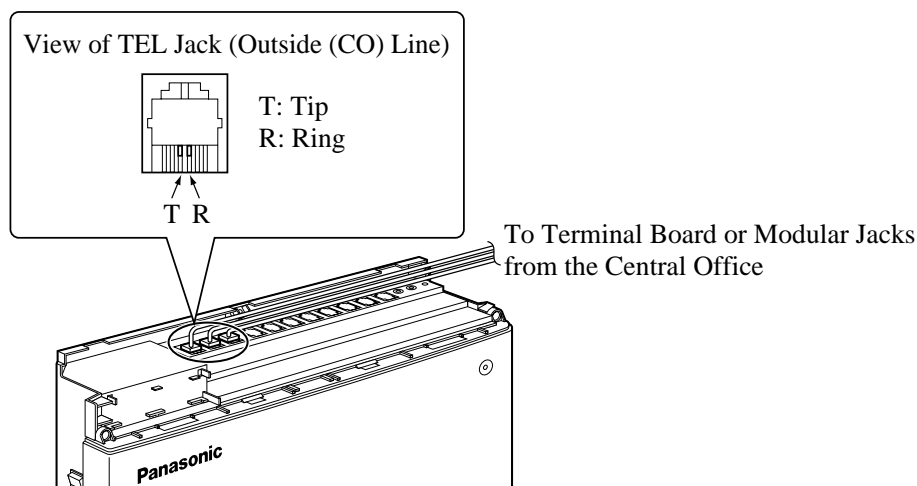

### *Installing Lightning Protectors*

A lightning protector is a device to be installed on an outside (CO) line to prevent a dangerous surge from entering the building and damaging the equipment.

A dangerous surge can occur if a telephone line comes in contact with a power line. Problems due to lightning surges has been steadily increasing with the development of electronic equipment.

In many countries, there are regulations requiring the installation of a lightning protector. A lightning strike to a telephone cable which is 10 m above ground can be as high as 200,000 volts.

This system should be installed with lightning protectors. In addition, grounding (connection to earth ground) is very important to protect the system (☞ 2.5, Frame Ground Connection).

#### *Recommended lightning protectors*

- TELESPIKE BLOK MODEL TSB (TRIPPE MFG. CO.)
- SPIKE BLOK MODEL SK6-0 (TRIPPE MFG. CO.)
- Super MAX™ (PANAMAX)
- MP1 (ITW LINK)

\* The illustration on this page is a KX-TA308.

## 2.7 Outside (CO) Line Connection

### Installation

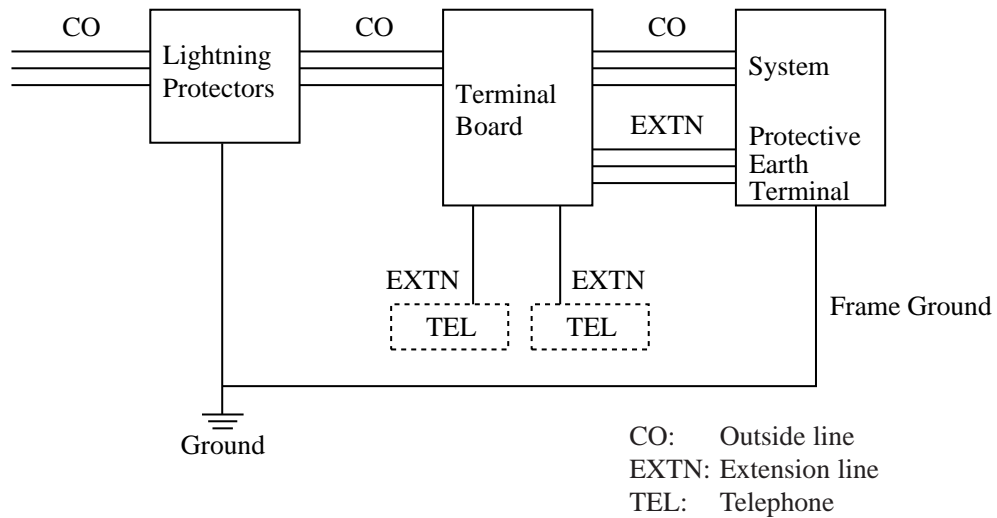

### Installation of an Earth Rod

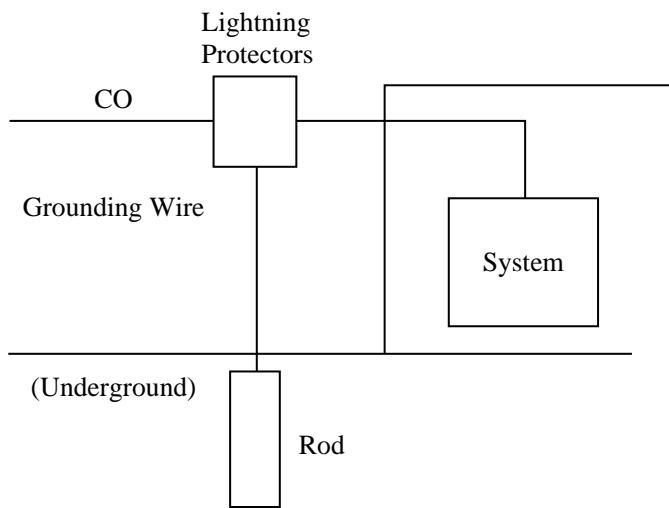

- 1) Installation location of the earth rod . . . . . Near the protector
- 2) Check obstructions . . . . . None
- 3) Composition of the earth rod . . . . . Metal
- 4) Depth of the earth rod . . . . . More than 50 cm
- 5) Size of the grounding wire . . . . . Thickness more than 16 AWG

**Note** • The above example is only a recommendation.  
 • The length of the earth rod and required depth depend on the composition of the soil.

## 2.8 Extension Connection

Extension jacks 01 through 08 for the KX-TA308 and extension jacks 01 through 16 for the KX-TA616 can be used for all kinds of telephones.

### Telephone Wiring

The maximum length of the extension line cord (twisted cable) which connects the system and the extension is as follows.

|   | Diameter of the line | Max. length |
|---|----------------------|-------------|
| <b>Single Line Telephone</b>                    | 22AWG                | 1798m       |
| (Station Loop Limit:<br>600 ohms including set) | 24AWG                | 1128m       |
|   | 26AWG                | 698m        |
| <b>Proprietary Telephone</b>                    | 22AWG                | 360m        |
| (Station Loop Limit:<br>40 ohms)                | 24AWG                | 229m        |
|   | 26AWG                | 140m        |

2 or 4-conductor wiring is required for each extension as listed below. There are 4 pins possible for connection: “T” (Tip), “R” (Ring), “L” (Low) and “H” (High).

| Telephone                                 | Wiring                   |
|---|--------------------------|
| Single line telephones                    | 1 pair wire (T, R)       |
| Proprietary telephone<br>(e.g., KX-T7330) | 2 pair wire (L, H, T, R) |



- If a telephone or answering machine with an A-A1 relay is connected to the system, set the A-A1 relay switch on the telephone or answering machine to the OFF position.

### Connection

Insert the modular plugs of the telephone line cords (2 or 4-conductor wiring) into the modular jacks on the system.

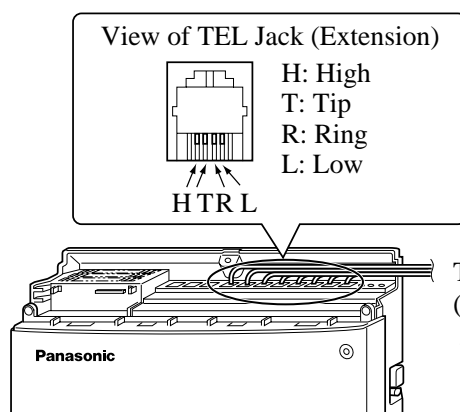

To extensions  
(JACK 01–08 for the KX-TA308,  
JACK 01–16 for the KX-TA616)

\* The illustration on this page is a KX-TA308.

## 2.9 External Pager (Paging Equipment) Connection

One external pager (user-supplied) can be connected to the system as illustrated below.

Use an EIAJ RC-6701 A plug (2-conductor,  $\phi$  3.5 mm in diameter).

- Output impedance: 600  $\Omega$

### Maximum length of the cable

AWG 18 – 22: Under 10 m

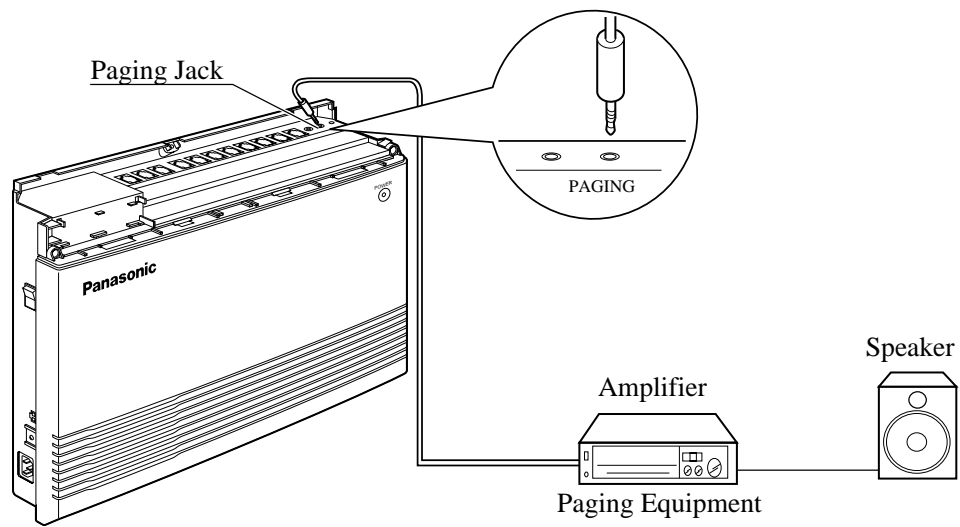

- To adjust the sound level of the pager, use the volume control on the amplifier.



- **Required System Programming**  
Section 4.2, System Programming  
[106] External Paging Access Tone
- **Feature Reference**  
Section 3, Features  
Paging

\* The illustration on this page is a KX-TA308.

## 2.10 External Music Connection

---

One music source, such as a radio (user-supplied), can be connected to the system as illustrated below.

Insert the plug to the earphone/headphone jack on the external music source.  
Use an EIAJ RC-6701 A plug (2-conductor,  $\phi$  3.5mm in diameter).

- Input impedance: 8  $\Omega$

### Maximum length of the cable

AWG 18 – 22: Under 10 m

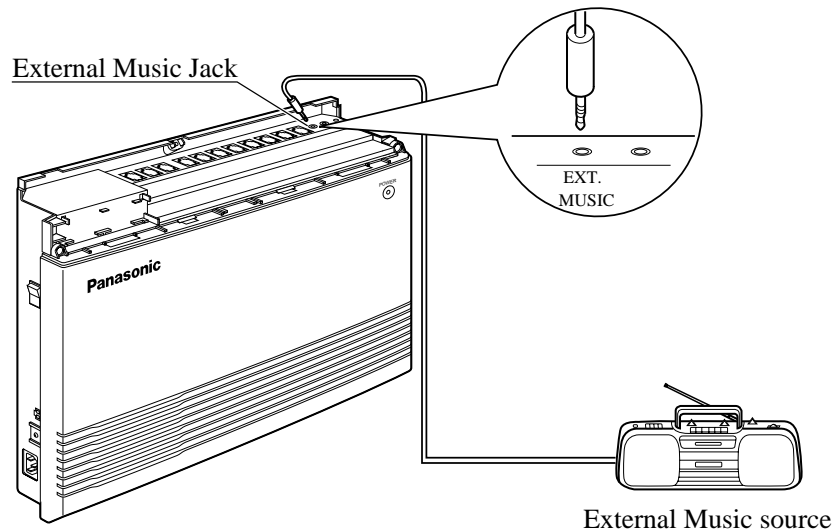

- System programming for the music sources used for Music on Hold and Background Music (BGM) is required.
- To adjust the sound level of the Music on Hold, use the volume control on the external music source.



- **Required System Programming**  
Section 4.2, System Programming  
[111] Hold Music Selection
- **Feature Reference**  
Section 3, Features  
Music on Hold / Background Music (BGM)

\* The illustration on this page is a KX-TA308.

## 2.11 Paralleled Telephone Connection

---

Any single line telephone can be connected in parallel with a proprietary telephone as follows.

### Using a Modular T-Adaptor

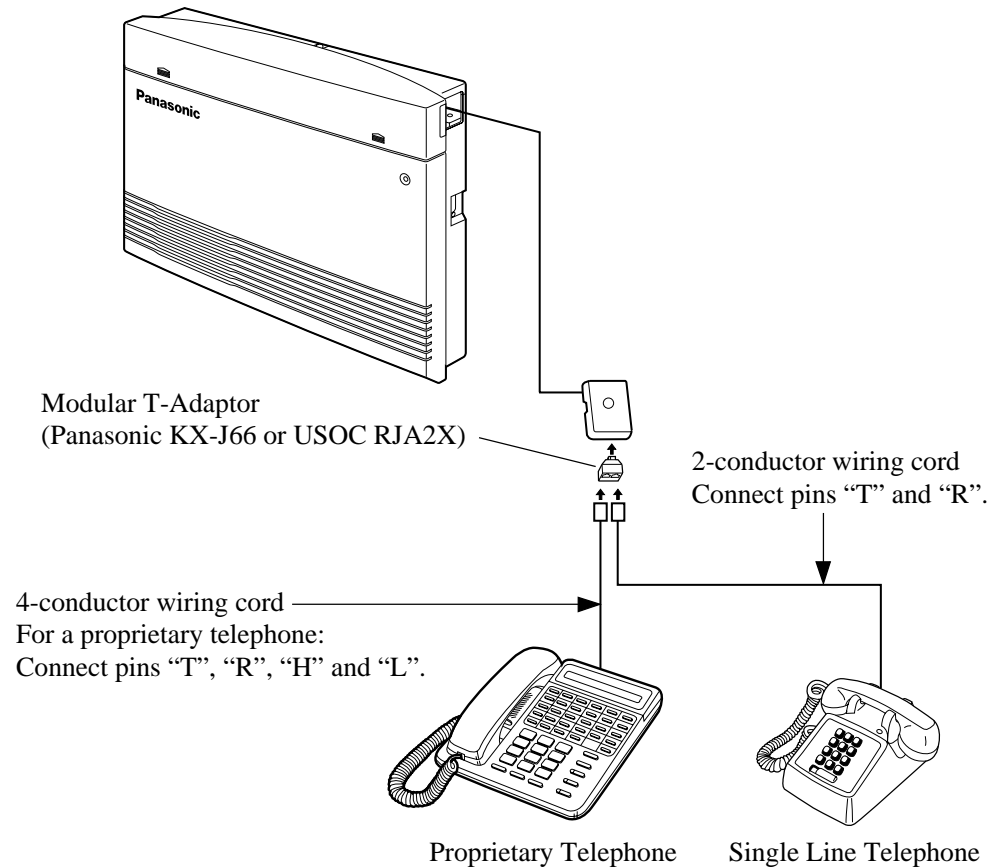

- **Required System Programming**  
Section 4.2, System Programming  
[610] Paralleled Telephone Connection
- **Feature Reference**  
Section 3, Features  
Paralleled Telephone Connection

## 2.12 Polarity Sensitive Telephone Connection

---

If your telephone is polarity sensitive, follow the procedure below:

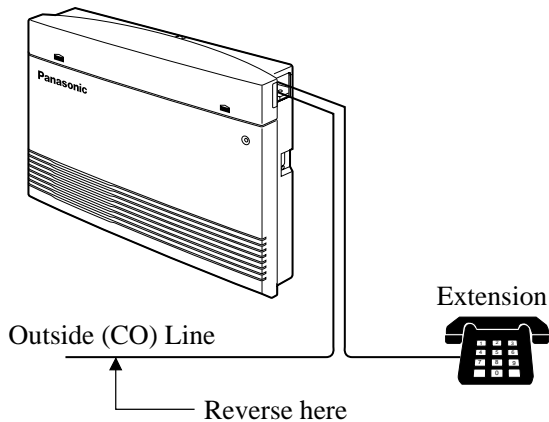
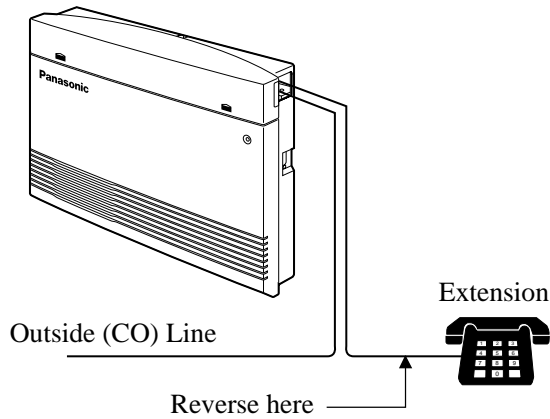

1. Complete all the required extension wiring.
2. Confirm that dialing can be done from all the extensions using a touch-tone telephone.  
If dialing fails, the polarity between the extension and the system must be reversed.
3. Reverse as shown.
4. Unplug the system.
5. Connect all outside lines.
6. Confirm that dialing can be done on the following extension using a touch-tone telephone.  
Extension (T, R) of jack 01: Outside (CO) line 1  
If dialing fails, the polarity between the system and the outside line must be reversed.
7. Reverse as shown.
8. Every time an extension telephone is replaced, repeat the procedure above.

## 2.13 Printer and PC Connection

---

A user-supplied printer or personal computer (PC) can be connected to the system. These are used to print out or refer to the SMDR call records and system programming data. Connect the printer cable or the PC cable to the Serial Interface (RS-232C) connector. The cable must be shielded and the maximum length is 2 m.

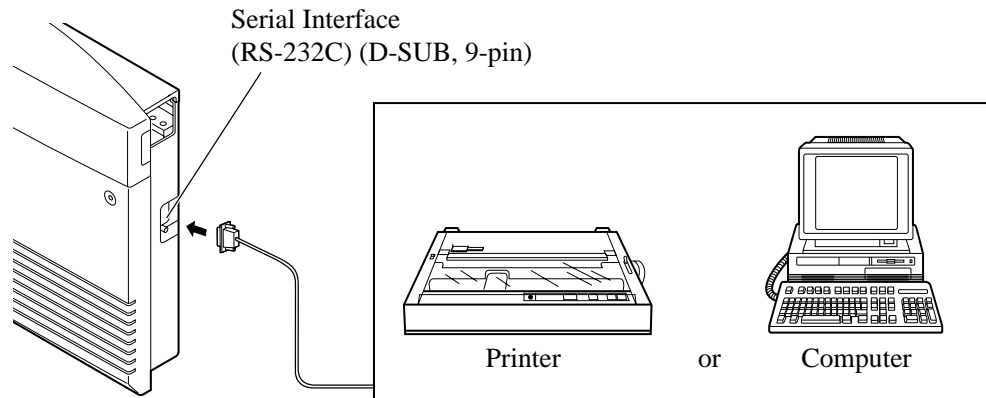

Arrange the cables so that the printer will be connected to the system as shown in the appropriate chart on the following page.

The pin configuration of the Serial Interface (RS-232C) Connector is as follows.

| Pin No. | Signal Name |                     | Circuit Type |       |
|---------|-------------|---------------------|--------------|-------|
|         |             |                     | EIA          | CCITT |
| 2       | RXD         | Received Data       | BB           | 104   |
| 3       | TXD         | Transmitted Data    | BA           | 103   |
| 4       | DTR         | Data Terminal Ready | CD           | 108.2 |
| 5       | SG          | Signal Ground       | AB           | 102   |
| 6       | DSR         | Data Set Ready      | CC           | 107   |
| 7       | RTS         | Request To Send     | CA           | 105   |
| 8       | CTS         | Clear To Send       | CB           | 106   |

## 2.13 Printer and PC Connection

### Connection Chart for a Printer / Personal Computer with the System

If you connect a printer or a PC with a 9-pin cable, follow the chart below.

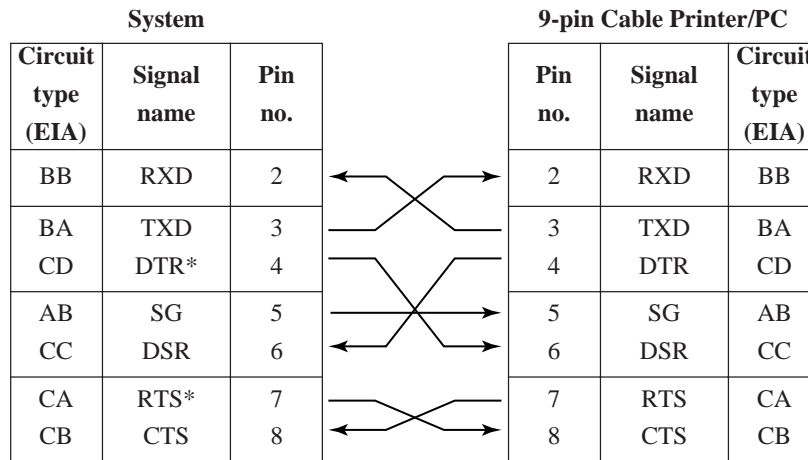

If you connect a printer or a PC with a 25-pin cable, follow the chart below.

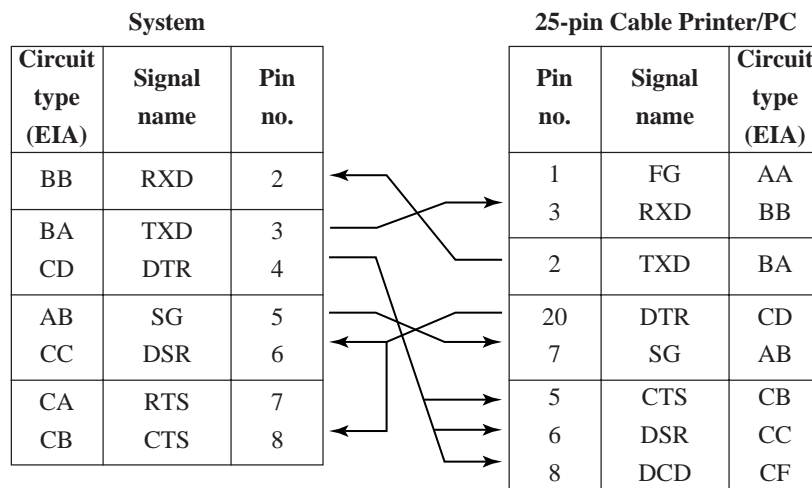

## 2.13 Printer and PC Connection

---

### Serial Interface (RS-232C) Signals

**Frame Ground: FG**

Connects the unit frame and the earth ground conductor of the AC power cord.

**Transmitted Data: SD (TXD) . . . . . (output)**

Conveys signals from the unit to the printer. A “Mark” condition is held unless data or BREAK signals are being transmitted.

**Received Data: RD (RXD) . . . . . (input)**

Conveys signals from the printer.

**Request to Send: RS (RTS) . . . . . (output)**

This lead remains ON whenever DR (DSR) is ON.

**Clear To Send: CS (CTS) . . . . . (input)**

When the CS (CTS) circuit is ON, it indicates that the printer is ready to receive data from the unit. The unit does not attempt to transfer data or receive data when the CS (CTS) circuit is OFF.

**Data Set Ready: DR (DSR) . . . . . (input)**

When the DR (DSR) circuit is ON, it indicates the printer is ready. The DR (DSR) circuit being ON does not indicate that communication has been established with the printer.

**Signal Ground: SG**

Connects the DC ground of the unit for all interface signals.

**Data Terminal Ready: ER (DTR) . . . . . (output)**

This signal line is turned ON by the unit to indicate that it is ON LINE. The ER (DTR) circuit being ON does not indicate that communication has been established with the printer. It is switched OFF when the unit is OFF LINE.

**Data Carrier Detect: CD (DCD) . . . . . (input)**

When ON, it indicates the data terminal (DTE) that the carrier signal is being received.



- **Required System Programming**
  - Section 4.2, System Programming
  - [800] SMDR RS-232C Communication Parameters
  - [801] SMDR Parameter
- **Feature Reference**
  - Section 3, Features
  - Station Message Detail Recording (SMDR)

## 2.14 Location of Optional Cards

---

The location of the optional cards is shown below.

**Precaution** To protect the printed circuit boards (P-boards) from static electricity, do not touch parts on the P-boards in the main unit and on the optional cards. If accessing the parts is required, wear a grounding strap.

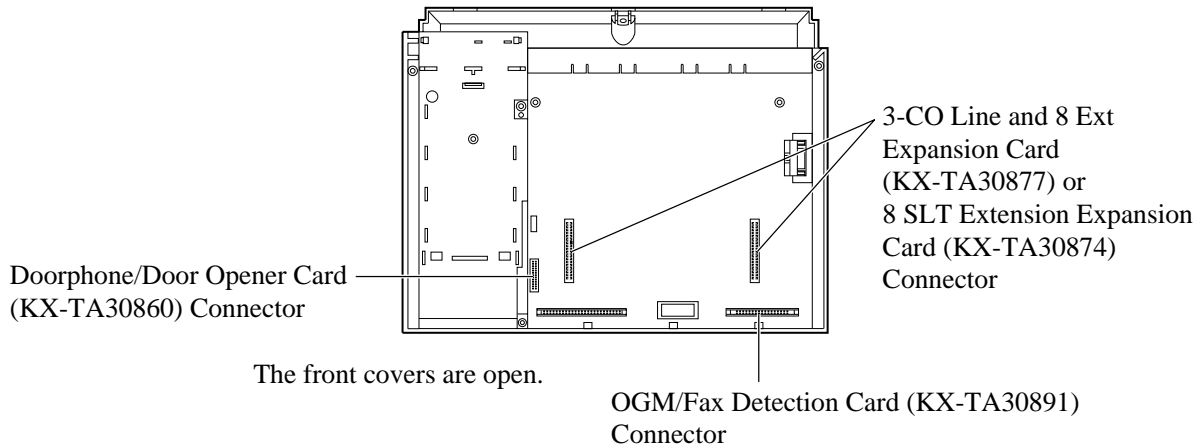

## 2.15 OGM/FAX Detection Card Installation

---

An optional OGM/FAX Detection Card (KX-TA30891) can be installed to the system.

**The OGM/FAX Detection Card** supports the following.

Direct Inward System Access (DISA) with OGM:

One of the system features. An outgoing message greets the external caller and gives information so that the caller can access an extension(s) directly.

Facsimile detection:

When the system receives a facsimile transmission signal by DISA, it automatically connects the specified facsimile extension.

1. Loosen the 2 screws.

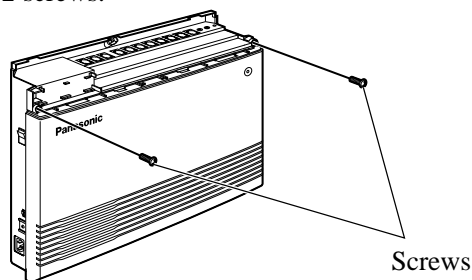

\* The illustrations on this page are a KX-TA308.

## 2.15 OGM/FAX Detection Card Installation

---

2. Open the bottom front cover.

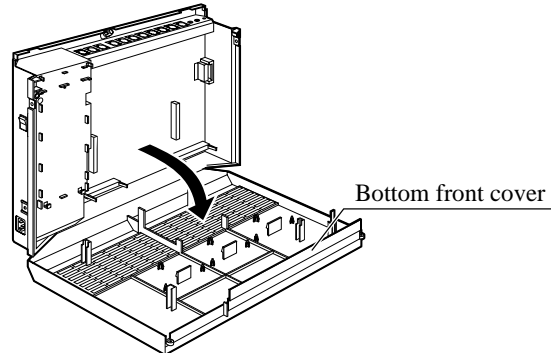

3. Attach the OGM/FAX Detection card.

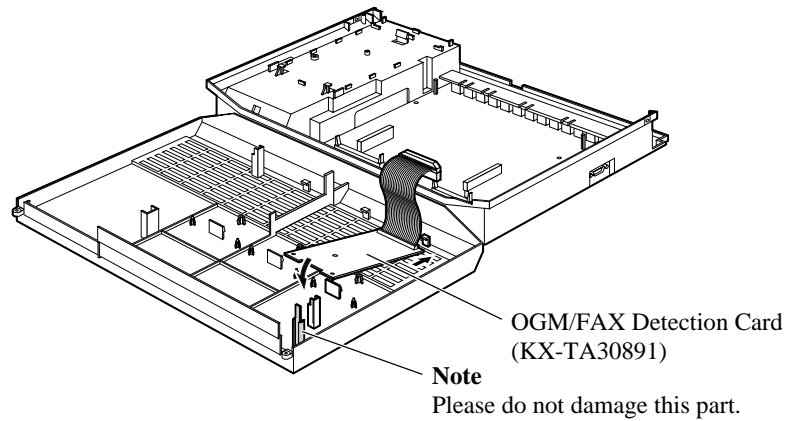

4. Insert the flat cables to the card connector.

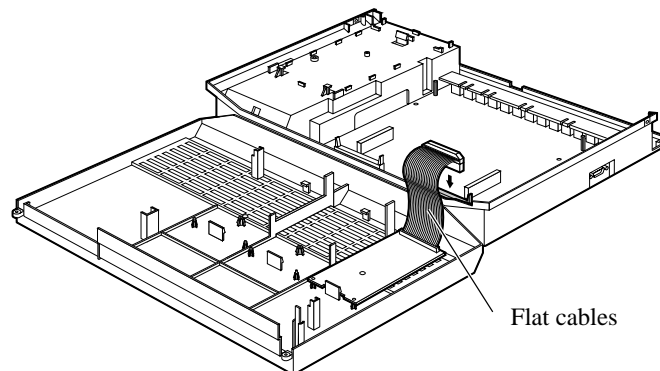

5. Replace the cover.



- **Required System Programming**

- See 'Required System Programming' in Section 3, Features "Direct Inward System Access (DISA)"

- **Feature References**

- Section 3, Features**

- Direct Inward System Access (DISA)

- Outgoing Message (OGM)

\* The illustrations on this page are a KX-TA308.

## 2.16 Doorphone and Door Opener Connection

---

Four doorphones (KX-T30865) and 4 door openers (user-supplied) can be installed.

### Maximum cable length

The maximum length of the doorphone and door opener line cord which connects the system is as follows.

|                                  | Diameter of the line | Max. length |
|----------------------------------|----------------------|-------------|
| <b>Doorphone</b>                 | 22AWG                | 180m        |
| (Station Loop Limit:<br>20 ohms) | 24AWG                | 113m        |
|                                  | 26AWG                | 70m         |
| <b>Door Opener</b>               | 22AWG                | 180m        |

### Installing the Doorphone

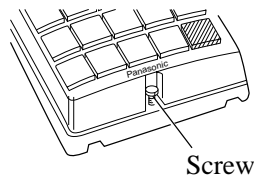

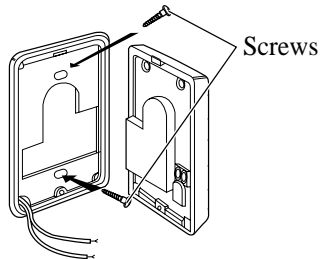

1. Loosen the screw to open the doorphone unit.



2. Attach the base cover to a wall using 2 screws.

**Note** Two kinds of screws are included. Please choose the appropriate one depending on your type of wall.

 Type 1: When a doorphone plate has been fixed to the wall.

 Type 2: When you wish to install the doorphone directly to the wall.

3. Connect the wires to the screws located in the front cover.

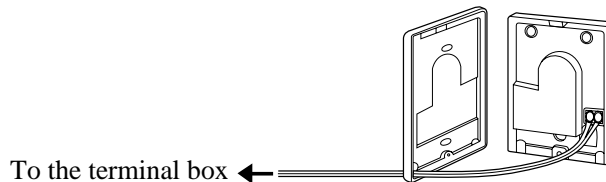

4. Put the doorphone together and re-install the screw.

## 2.16 Doorphone and Door Opener Connection

---

### Doorphone/Door Opener Installation

Attach the optional Doorphone/Door Opener Card to the main unit, connect the cord to the Doorphone/Door Opener Card Connector and secure the screw.

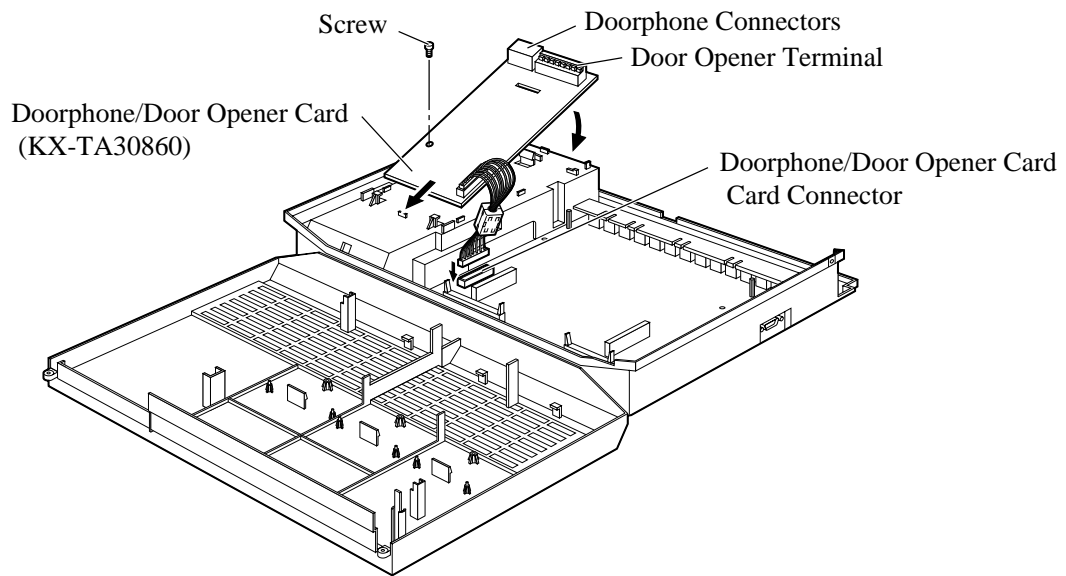

\* The illustration on this page is a KX-TA308.

## 2.16 Doorphone and Door Opener Connection

### Wiring of the Doorphone

1. Connect the Doorphone/Door Opener Card to the terminal boxes using 4-conductor modular connectors.
2. Connect the wires of doorphones 1 and 3 to the red and green screws on the terminal box.
3. Connect the wires of doorphones 2 and 4 to the yellow and black screws on the terminal box.

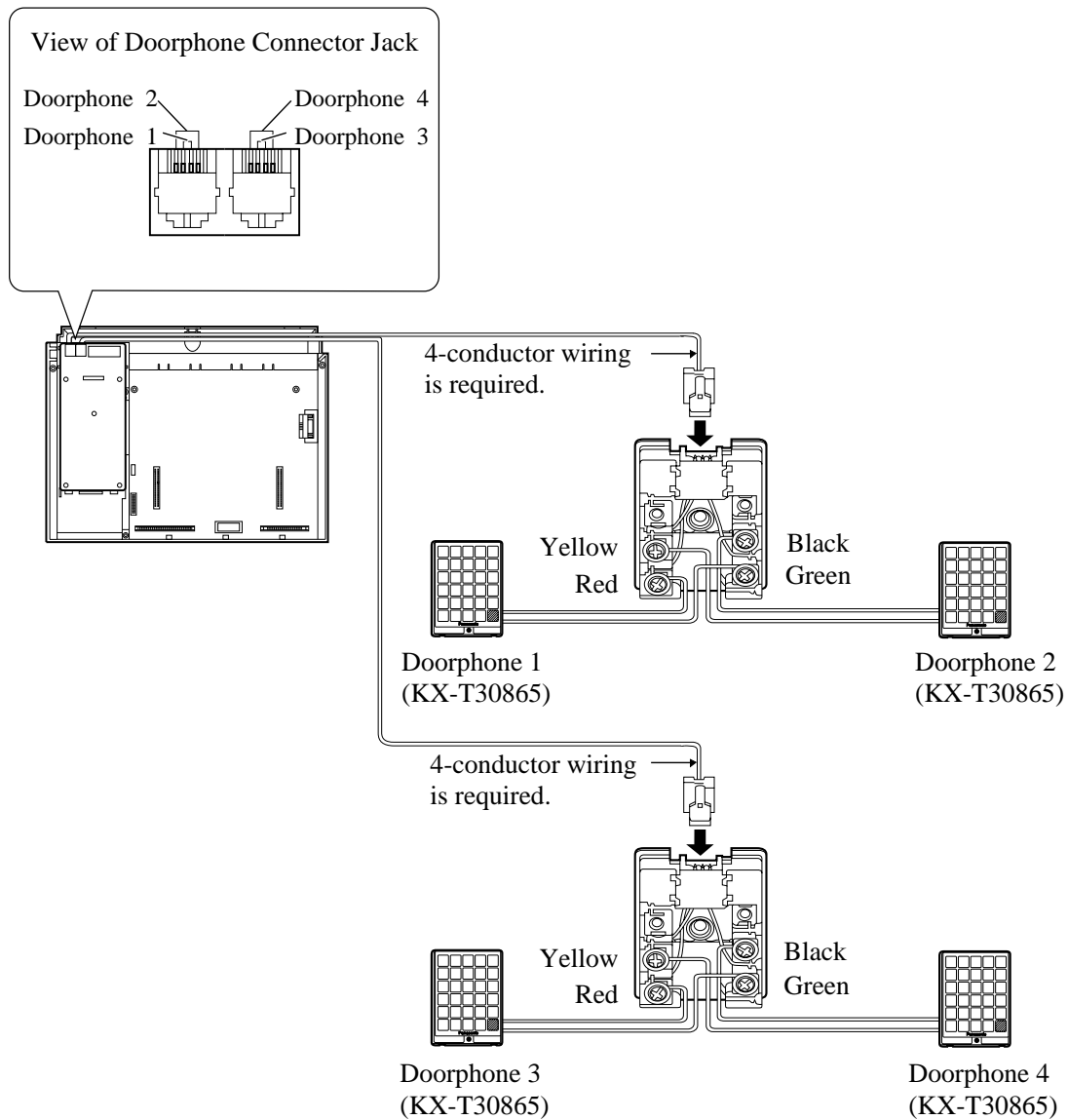

\* The illustration on this page is a KX-TA308.

## 2.16 Doorphone and Door Opener Connection

### Connecting Door Openers

1. While pressing the button below a hole with a driver, insert the wire from the door opener into the hole.

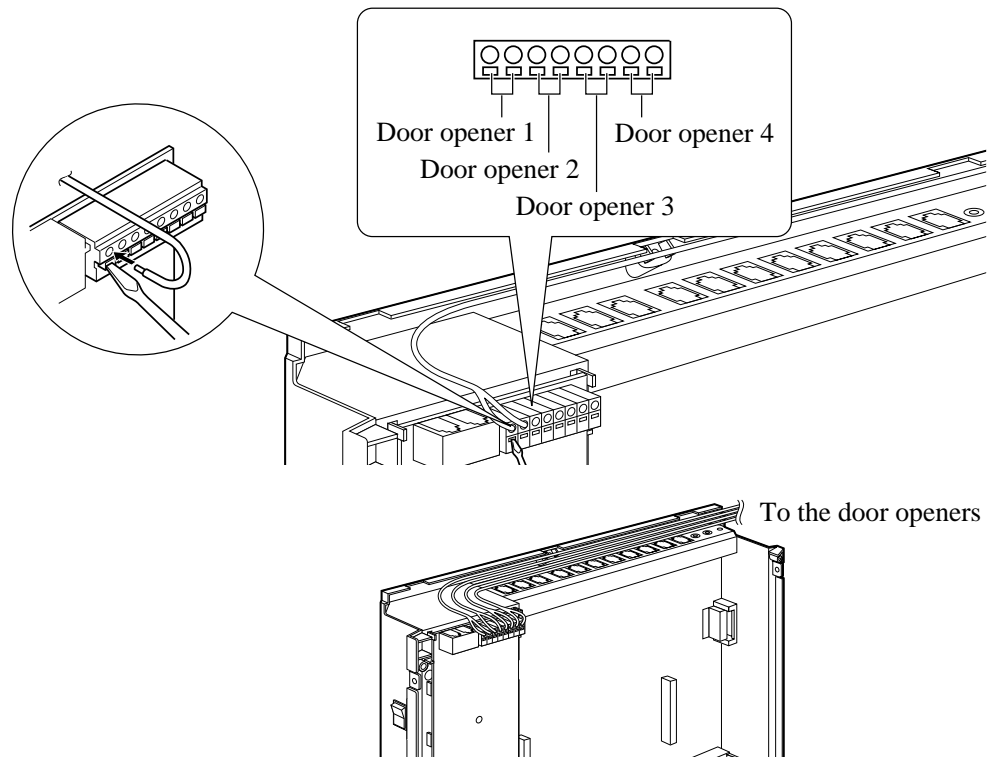

2. Wrap the strap around all of the cords. (➔ 2.20, Securing the Cords)



- We recommend using UL1015 wire or the equivalent for wiring.
- The wire should be between 0.4 and 1.2 mm in diameter including the coating.

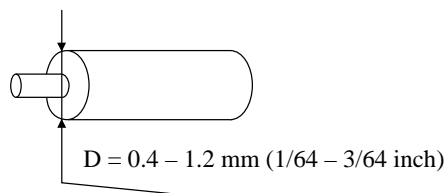

- **Required System Programming**

- Section 4 System Programming

- [700]–[702] Doorphone Ringing Assignment — Day/Night/Lunch

- [703]–[705] Door Opener Assignment — Day/Night/Lunch

- **Feature References**

- Section 3, Features

- Door Opener, Doorphone Call

\* The illustrations on this page are a KX-TA308.

## 2.17 Backup Batteries Connection

---

Two car batteries can be connected to the system as a backup power supply in the event of a power failure.

1. Attach the cables (KX-A227) and user-supplied 2 car batteries (12 VDC each) as shown below. Then insert the connector to the system.

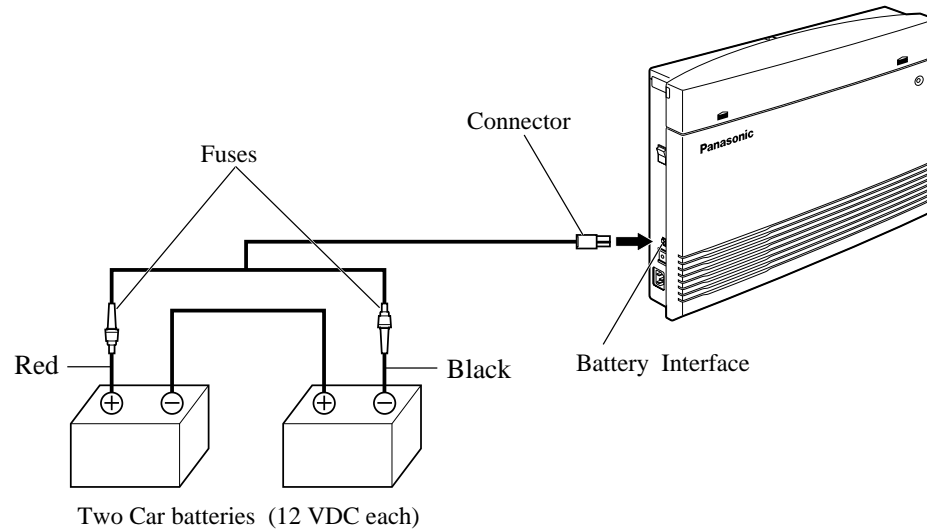

## 2.18 *Installing a 3-CO Line & 8 Ext Expansion Card (KX-TA30877) and 8 SLT Extn. Expansion Card (KX-TA30874)*

---

### **3-CO Line and 8 Ext Expansion Card Installation (KX-TA30877)** — for KX-TA308 only

To add 3 outside (CO) lines (outside (CO) lines 4 through 6) and 8 extensions (extension jacks 09 through 16), use an optional 3-CO Line and 8 Ext Expansion Card (KX-TA30877).

### **8 SLT Extension Expansion Card Installation (KX-TA30874)**

To add 8 extensions (extension jacks 17 through 24), use an optional 8 SLT Extension Expansion Card (KX-TA30874).

This card can be installed directly to the system or to the KX-TA30877.



- Only a single line telephone (SLT) can be connected to extension jacks 17 through 24.

### **Installing the KX-TA30877 to the KX-TA308**

1. Loosen the screws and open the top and bottom front covers.
2. Remove the lower front panel with pliers as shown below. Cut the 6 areas marked with a circle.

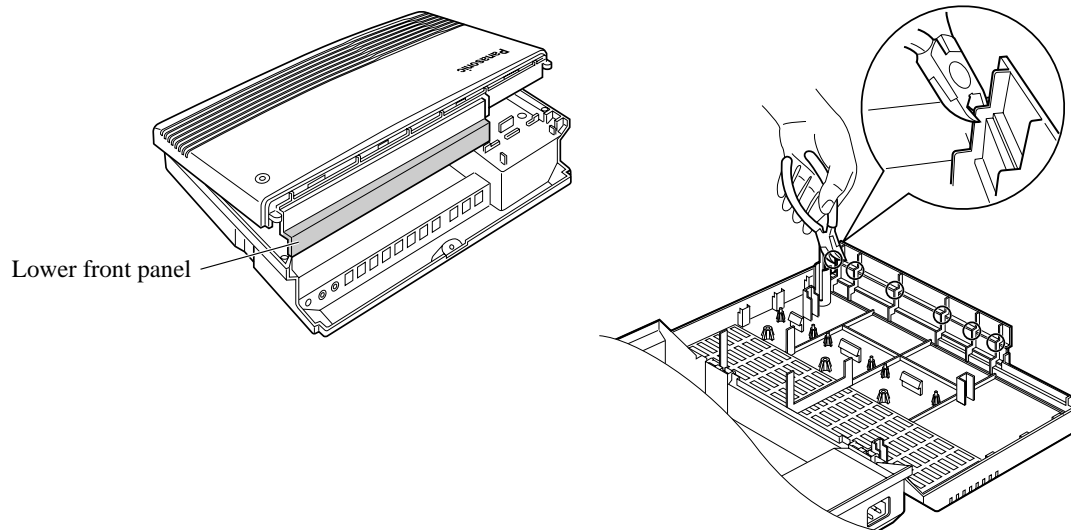

## 2.18 *Installing a 3-CO Line & 8 Ext Expansion Card (KX-TA30877) and 8 SLT Extn. Expansion Card (KX-TA30874)*

---

3. After cutting the areas, be sure to cut off any excess plastic in order to make the surface smooth.

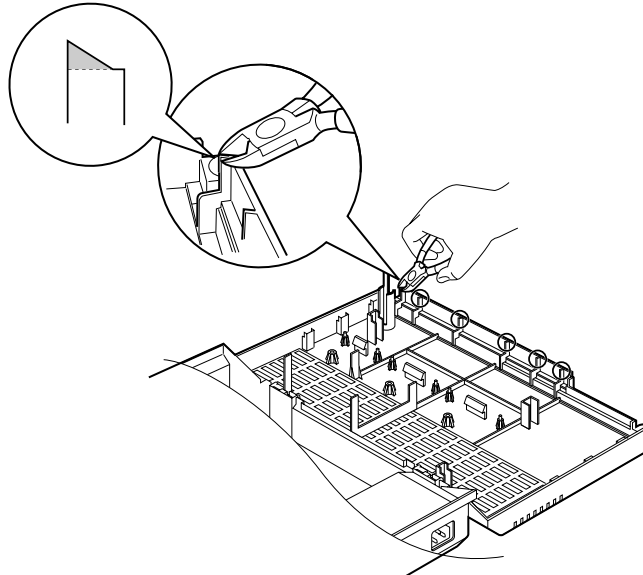

4. First, insert the plastic spacer into the hole on the KX-TA30877. Attach the 2 extension connectors to the system, install the KX-TA30877 and secure the 2 extension bolts.

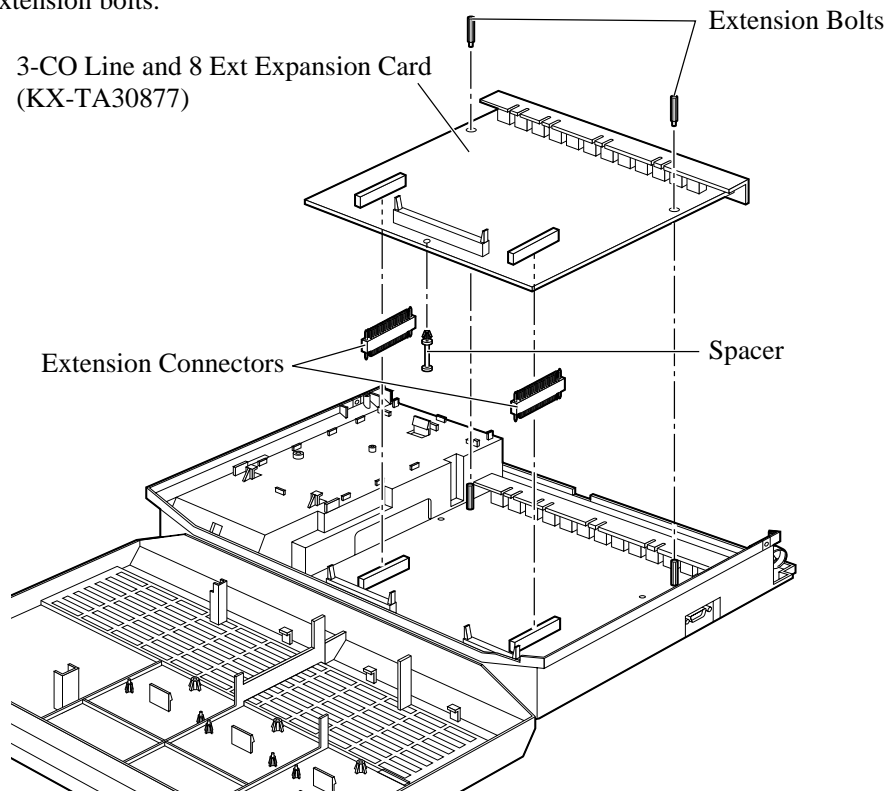

## 2.18 *Installing a 3-CO Line & 8 Ext Expansion Card (KX-TA30877) and 8 SLT Extn. Expansion Card (KX-TA30874)*

---

5. Insert the modular plugs of the telephone line cords (2-conductor wiring) into the modular jacks (CO 4 through 6) on the card. (☞ 2.7, Outside (CO) Line Connection)
6. Connect the line cords to the terminal board or the modular jacks from the Central Office.
7. Insert the modular plugs of the telephone line cords (2 or 4-conductor wiring) into the modular jacks (JACK 09 through 16). (☞ 2.8, Extension Connection)
8. Wrap the strap around all of the cords. (☞ 2.20, Securing the Cords)
9. Close the covers and secure the screws.

### *Installing the KX-TA30874*

1. Loosen the screws and open the front and bottom front covers.
2. If your system is a KX-TA308, remove the lower front panel in the same way as installing a KX-TA30877. If you install the KX-TA30874 to a KX-TA616 or a KX-TA30877, which is connected to a KX-TA308, remove the top front panel with pliers.

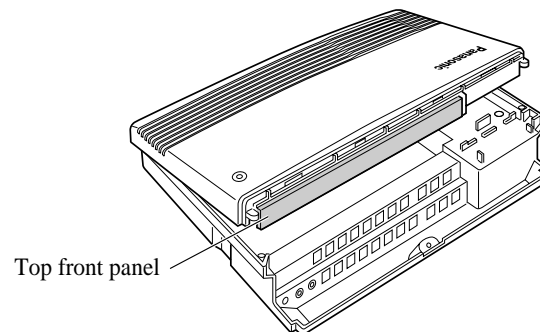

3. After cutting the areas, be sure to cut off any excess plastic in order to make the surface smooth. Please refer to installing the KX-TA30877.

## 2.18 *Installing a 3-CO Line & 8 Ext Expansion Card (KX-TA30877) and 8 SLT Extn. Expansion Card (KX-TA30874)*

---

4. Attach the 2 extension connectors to the system first, install the KX-TA30874 and secure the 2 screws.

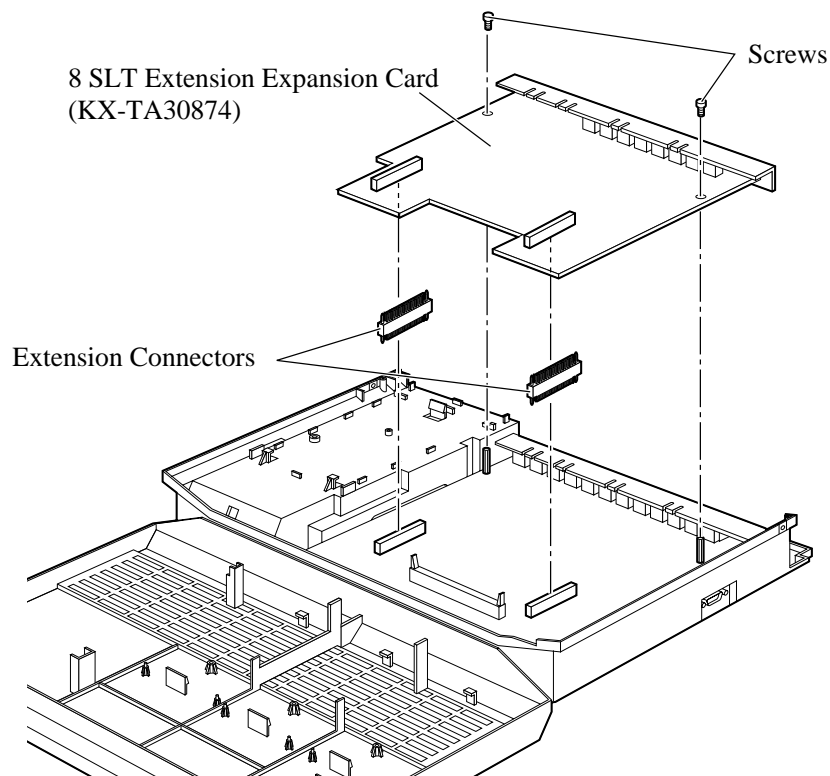

5. Insert the modular plugs of the telephone line cords (2-conductor wiring) into the modular jacks (JACK 17 through 24). (↔ 2.8, Extension Connection)
6. Wrap the strap around all of the cords. (↔ 2.20, Securing the Cords)
7. Close the covers and secure the screws.

\* The illustration on this page is a KX-TA308.

## 2.18 *Installing a 3-CO Line & 8 Ext Expansion Card (KX-TA30877) and 8 SLT Extn. Expansion Card (KX-TA30874)*

---

### *Installing the KX-TA30877 and KX-T30874 — for KX-TA308 only*

1. Install the KX-TA30877 first and then the KX-TA30874.

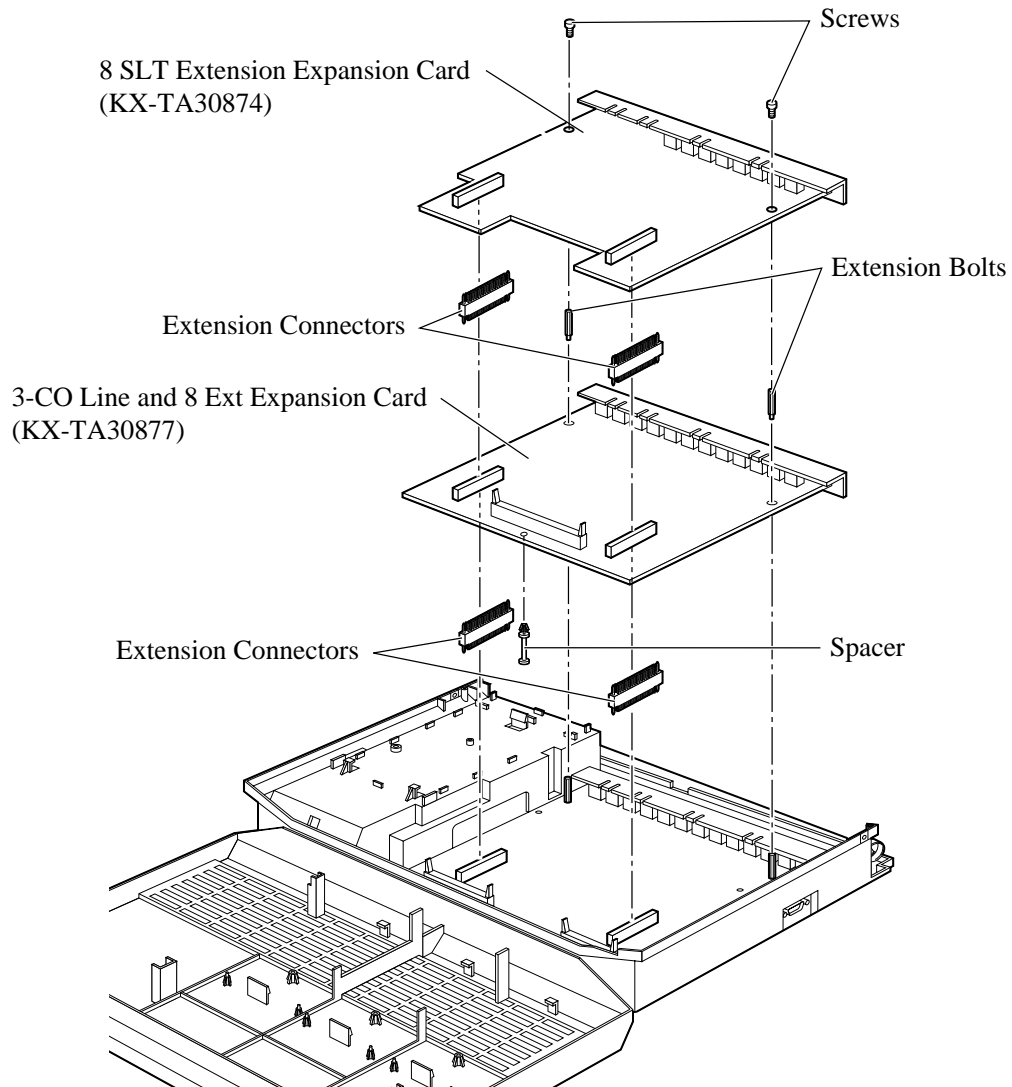

## 2.19 *Auxiliary Connection for Power Failure Transfer*

---

Power failure transfer connects a specific single line telephone (SLT) to selected outside (CO) lines in the event of system power failure, as follows.

Outside (CO) line 1 – extension (T, R) jack 01

Outside (CO) line 4 – extension (T, R) jack 09

Connection of outside (CO) lines 1 and 4, and the respective extensions require no auxiliary connection.



- In the event of a power failure, system memory is protected by a factory-provided lithium battery. There is no memory loss except the Camp-on, Saved Number Redial, Last Number Redial, Call Park and Message Waiting memories.
- The system automatically changes the current connection to this connection when the power supply stops.
- Proprietary telephones cannot be used during a power failure. Therefore, we recommend connecting SLTs in parallel with proprietary telephones connected to extension jacks 01 and 09, or connecting a KX-T7033 (power failure telephone).
- If DC power is available from backup batteries when AC power fails, the system will not change the current connection to the above connection. (☞ 2.17, Backup Batteries Connection)



- **Feature References**

Section 3, Features

Power Failure Transfer, Paralleled Telephone Connection

## 2.20 *Securing the Cords*

---

1. Insert the rivet into the hole in the strap.
2. Insert the rivet and strap into the hole on the system.

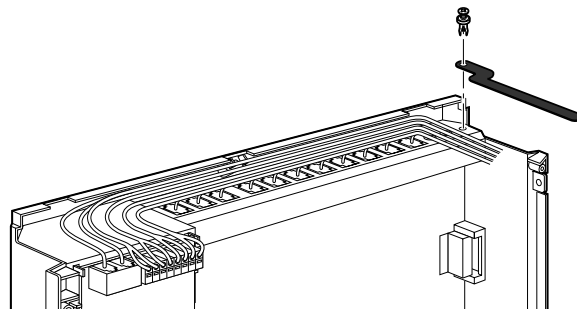

\* The illustration on this page is a KX-TA308.

## 2.20 *Securing the Cords*

---

3. Wrap the strap around all of the cords.

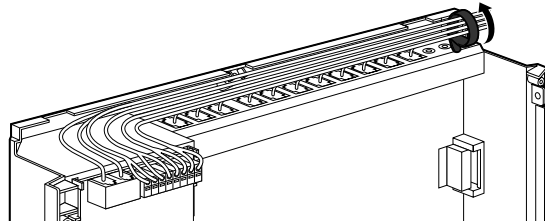

4. To remove the rivet, use a screw driver as shown below.

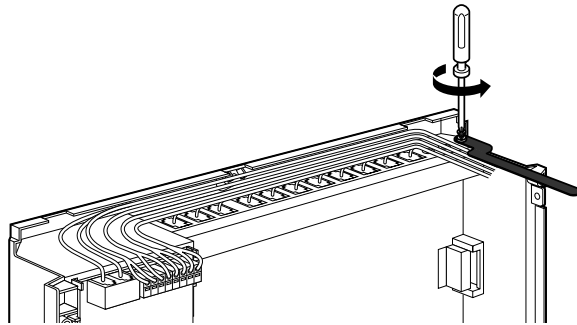

## 2.21 *Closing the Front Cover*

---

1. Replace the covers and tighten the screws.
2. Tie together all of the connected cords and attach them to the wall so that the cords cannot be pulled out of the system.

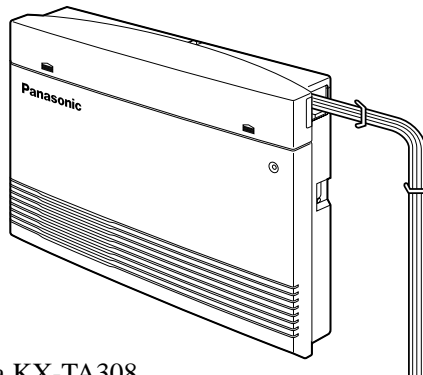

\* The illustrations on this page are a KX-TA308.

## 2.22 *Starting the System for the First Time*

---

1. Set the Power Switch to the “OFF” position.
2. Plug the AC power cord into the system and an AC outlet.
3. Turn the Power Switch on.  
(The power indicator will light.)
4. Perform the following operation with a proprietary telephone connected to JACK 01.
  - a) Press the PROGRAM button, or set the MEMORY switch to “PROGRAM” on the back of the telephone.
  - b) Press \* #.
  - c) Enter 1234.
  - d) Enter 999.
  - e) Press the NEXT (SP-PHONE) button.
  - f) Press the SELECT (AUTO ANS/MUTE or AUTO ANSWER/MUTE) button until “All Para” is displayed.
  - g) Press the STORE (AUTO/STORE or AUTO DIAL/STORE) button.
  - h) Press the END (HOLD) button.
  - i) Press the PROGRAM button, or set the MEMORY switch to “SET” on the back of the telephone.

The system will be initialized with the default values. If the system does not work properly, please see 2.24, “System Data Clear”.

- CAUTION**
- The system will continue to be powered even if the Power Switch is turned “OFF”.
  - The power supply cord is used as the main disconnect device. Ensure that the outlet is located/installed near the equipment and is easily accessible.

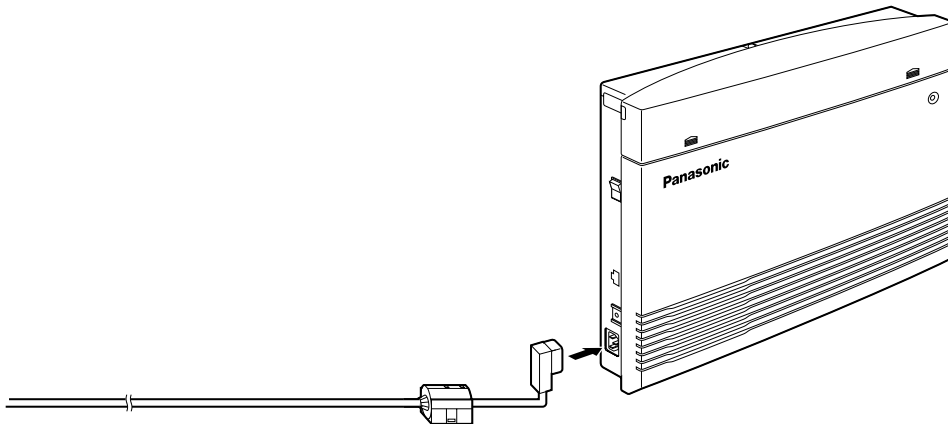

## 2.22 *Starting the System for the First Time*

---

### *Plug Adaptor*

The plug adaptor (included) is to be used if the power plug will not fit your socket. Assemble as shown below, using the plug which fits your socket. In this case, be sure to connect the frame of the main unit to ground because the ground line in the power cable cannot be used.

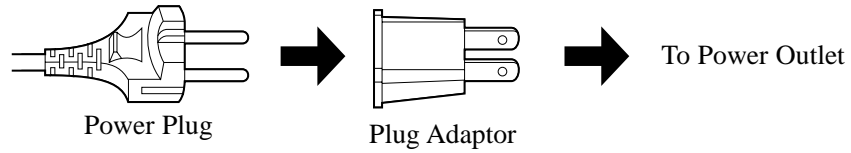

## 2.23 *System Restart*

---

After starting the system, if the system does not operate properly, restart the system.

Before restarting the system, try the system feature again to confirm whether there definitely is a problem or not.

System Restart causes the following.

- Camp-on is cleared.
- Calls on Hold are terminated.
- Calls on Exclusive Hold are terminated.
- Calls in progress are terminated.
- Call Park is cleared.
- Message Waiting is cleared.
- Last Number Redial is cleared.
- Saved Number Redial is cleared.

Other data is not cleared by System Restart.

1. Turn the Power Switch “OFF” and then “ON”.

- !** • If the system still does not operate properly, please see 2.24, “System Data Clear”.

## 2.24 System Data Clear

---

When the system does not operate properly after restarting, you can clear the programming data stored in the system. The system will restart with the default settings.

First, try system program [999] “System Data Clear” by following step 4 in 2.22, “Starting the System for the First Time”. If the system still does not operate properly, please follow the procedures below.

1. Slide the System Clear Switch to the “CLEAR” position.
2. Press the Reset Button.
3. Return the System Clear Switch to the “NORMAL” position before the power indicator stops flashing.  
(The power indicator will flash for about 10 seconds.)

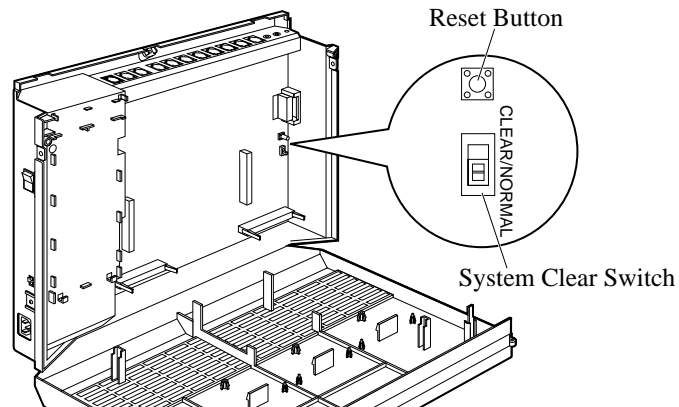

**CAUTION** • Before touching the System Clear Switch and Reset Button, put on a grounding strap.



- After pressing the Reset Button, return the System Clear Switch to the “NORMAL” position in step 3 before the power indicator stops flashing. Otherwise, the system will not clear.



- **Feature Reference**  
Section 3, Features  
System Data Default Set

\* The illustration on this page is a KX-TA308.

*Section 3*  
*Features*

## Absent Message Capability

Allows an extension user to set a message which will be displayed at the calling extension to show the reason for the called extension's absence. One of 6 messages can be programmed as desired, which are available for any telephone (single line telephone or proprietary telephone). Setting or canceling a message can be done by individual extension users but only callers using a proprietary telephone with a LCD can see the message.



- The 6 messages are shown below. “%” means a parameter to be entered when assigning a message at an extension.
  - (1) Will Return Soon
  - (2) Gone Home
  - (3) At Ext %%% (extension number)
  - (4) Back at %% : %% AM (or PM) (hour : minute)
  - (5) Out Until %%/%% (month / day)
  - (6) In a Meeting
- An extension user can only select one message at a time. The selected message is displayed every time the user goes off-hook.



- **Operating Instructions Reference**
  - 1.6 Before Leaving Your Desk, “Showing Your Message on the Calling Party's Display (Absent Message Capability)”

## Account Code Entry

An account code is used to identify incoming and outgoing outside calls for accounting and billing purposes. The account code is appended to the SMDR call record. For incoming outside calls, an account code is optional. For outgoing outside calls, there are 4 account input modes programmable in program [605], Option, Forced, Verify-All and Verify-Toll.

- Option:** A 4 digit code may be entered during a conversation or within 30 seconds after a conversation when a record is needed.
- Forced:** A 4 digit code must be entered within 5 seconds after an outside (CO) line is seized. The code can be any number.
- Verify-All:** Enables to make an outside call if the code entered within 5 seconds after an extension user seize an outside (CO) line is the same as one of the account codes programmed in [310].
- Verify-Toll:** Enables to make an outside call depending on the code entered within 5 seconds after an outside (CO) line is seized. If it is the same as one of the account codes programmed in [310], your COS is applied. If it is the same as the extension password, the extension COS is applied. If the entered code is both an account code and the extension password, the extension password has priority.



- **Required System Programming**
  - [310] Account Codes
  - [605] Account Code Entry Mode
  - [805] SMDR Account Code Selection
- **Related Feature References**
  - Station Message Detail Recording (SMDR),
  - Toll Restriction Override by Extension Password
- **Operating Instructions Reference**
  - 1.7 Useful Features, “Calling with Account Codes (Account Code Entry)”

### *Alternate Calling – Ring/Voice (Voice to Ring only)*

This system offers a proprietary telephone user 2 types of intercom calling, Voice Call mode and Tone (ring) Call mode. “Voice Call” informs the called party of an incoming call with the calling party’s voice, while “Tone Call” uses a ring tone. A proprietary telephone user can select “Voice Call” or “Tone Call” in the Proprietary Telephone Settings. If the user selects “Voice Call”, the calling party can talk to the user immediately after the confirmation tone. The calling party can switch the pre-set mode at the called extension, from “Voice Call” to “Tone Call”, by pressing “\*” after dialing the extension number.



- A rotary telephone user cannot change the pre-set mode at the called extension.



- **Operating Instructions References**
  - 1.2 Proprietary Telephone Settings, “Customizing Your Telephone Functions”, Intercom Alert Assignment
  - 1.7 Useful Features, “Alternate Calling – Ring/Voice (Voice to Ring only)”

### *Automatic Callback Busy (Camp-On)*

When the selected outside (CO) line or dialed extension is busy, the system will automatically notify an extension user with a callback ringing when the line becomes available. When the user answers the callback ringing:

**For an extension:** The called extension starts ringing without dialing.

**For an outside (CO) line:** The line is seized.



- **Operating Instructions Reference**
  - 1.3 Making Calls, “Making Your Telephone Ring Back Automatically When a Line Becomes Free (Automatic Callback Busy – Camp-On)”

### *Automatic Outside (CO) Line Access Number*

An Automatic Line Access number (0 or 9) can be programmed. When an extension user dials an Automatic Line Access number before a telephone number, an available outside (CO) line from the assigned lines in program [419] is seized automatically. If “0” is selected in program [121], the operator call will be “9” automatically. If “9” is selected in program [121], the operator call will be “0” automatically.



- **Related Feature References**

Operator Call, Outside Calling

- **Required System Programming**

[121] Automatic Outside (CO) Line Access Number Selection

[419] Automatic Designated Outside (CO) Line Access

### *Busy Station Signaling (BSS)*

When an extension user calls a busy extension, the busy extension will hear a Call Waiting tone to know that a call is waiting.



- This feature is only available if the called extension has set the Call Waiting feature. If the Call Waiting feature is activated, the caller will hear a ringback tone. If not, the caller will hear a reorder tone.



- **Related Feature Reference**

Call Waiting

- **Operating Instructions Reference**

1.3 Making Calls, “Sending a Call Waiting Tone to a Busy Extension (Busy Station Signaling)”

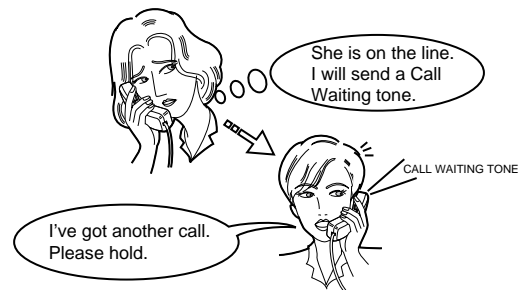

## Call Forwarding

Allows an extension user to transfer incoming calls automatically to another extension or to an external destination. The following types are available.

- All Calls:** All incoming calls are forwarded to another extension.
- Busy or No Answer:** All incoming calls are forwarded to another extension when the extension user does not answer within the programmed time in [202] or when the extension is busy.
- To an Outside(CO) Line:** Allows an extension user enabled in program [607] to forward all incoming calls to an external party.
- Follow Me:** Allows an extension user to set the Call Forwarding – All Calls feature from another extension.



- Extensions which have already been assigned as a forwarded destination cannot set the Call Forwarding feature.
- If the Do Not Disturb (DND) feature has already been set, setting the Call Forwarding feature will cancel DND.
- If a call between 2 outside parties is established by the Call Forwarding – to Outside (CO) Line feature, the duration of the call is determined by the system timer assigned in program [205]. An alarm tone is generated to both outside parties 15 seconds before the timeout. The call will be disconnected at the timeout.



- **Required System Programming**
  - [202] Call Forwarding Start Time
  - [205] Outside-to-Outside (CO-to-CO) Line Duration Time Limit
  - [607] Call Forwarding to an Outside (CO) Line
- **Related Feature Reference**
  - Limited Call Duration
- **Operating Instructions References**
  - 1.2 Proprietary Telephone Settings, “Customizing the Buttons on Your Telephone”, FWD/DND (Forward/Do Not Disturb) Button
  - 1.6 Before Leaving Your Desk, “Forwarding a Call (Call Forwarding)”

## Calling Party Control (CPC) Signal Detection

The Calling Party Control (CPC) signal is a disconnect signal sent from the Central Office for an outside call. The CPC signal detection is activated by programs [420] and [421]. Program [420] is for incoming outside calls, and [421] is for outgoing outside calls.



- **Required System Programming**
  - [420] Calling Party Control (CPC) Signal
  - [421] CPC Detection for Outgoing Calls

## Call Park

Allows an extension user to place a held call into a system parking area. Any extension user can retrieve the parked call to perform other operations. Up to 10 calls can be parked at the same time.



- If a parked call is not retrieved within the assigned time in program [200], a ring tone or an alarm tone will be heard.
- If a parked call is not retrieved within 30 minutes, it will be automatically disconnected.
- This feature is useful when an extension user wants to hold more than one intercom call with a proprietary telephone, or more than one intercom call or outside call with a single line telephone.
- During a 5-party conference, this feature cannot be performed.



- **Required System Programming**  
[200] Hold Recall Time
- **Related Feature Reference**  
Conference (5-party)
- **Operating Instructions Reference**  
1.5 During Conversation, "Placing a Call in System Parking Area (Call Park)"

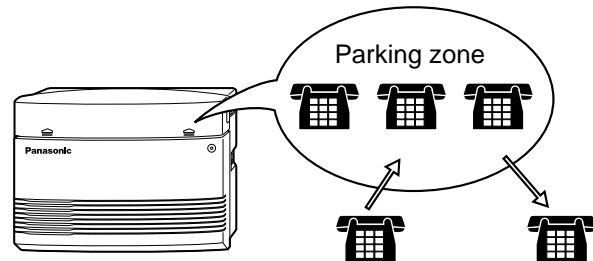

## Call Pickup

### <Directed Call Pickup>

Allows an extension user to answer a call ringing at any other extension.

### <Group Call Pickup>

Allows an extension user to answer a call ringing at another extension, if the call is ringing within the user's extension group assigned in program [600].

### <Call Pickup Deny>

Allows an extension user to prevent other extensions from picking up a call ringing at the user's extension with the Call Pickup feature.

### <Call Retrieving from a TAM (Telephone Answering Machine)>

Allows an extension user to answer an incoming call received by a TAM extension assigned in program [611].



- The user can pick up an incoming outside, intercom or doorphone call with the Directed Call Pickup or Group Call Pickup feature.
- A confirmation tone is sent to the user when the call is picked up with the Directed Call Pickup or Group Call Pickup feature. The tone can be disabled in program [117].
- If a ringing extension sets the Call Pickup Deny feature, an extension user will hear a reorder tone when the user tries to pick up the call.



#### • Required System Programming

- [117] Call Pickup Tone
- [600] Extension Group Assignment
- [611] TAM (Telephone Answering Machine) Extension

#### • Operating Instructions Reference

- 1.4 Receiving Calls, "Picking up a Call Ringing at Another Extension (Call Pickup)"

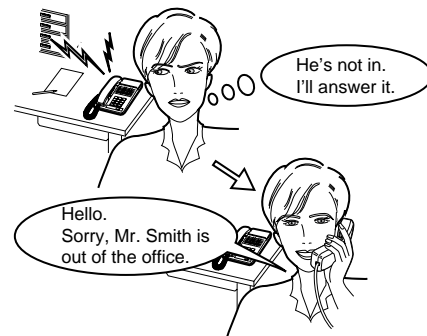

## Call Splitting

Allows an extension user to talk to 2 different parties. If a call is received while the user is already on the line, the user can place the current call on hold and have a conversation with the other party.



- This feature is not possible for a doorphone call, page or 5-party conference.



#### • Related Feature References

- Conference (5-party), Doorphone Call, Paging

#### • Operating Instructions Reference

- 1.5 During Conversation, "Call Splitting"

### *Call Transfer – to Extension*

Allows an extension user to transfer a received call, an intercom or an outside call, to another extension. Two types are available.

**Screened Call Transfer:** Announces the call to another extension before completing the transfer.

**Unscreened Call Transfer:** Immediately releases the call to another extension without an announcement.



- If the destination extension does not answer the call within the assigned time in program [201], the call will return to the transferring party.
- An outside call can be transferred to an extension by simply pressing a DSS button. It requires program [005].
- If Music on Hold is enabled, music is sent to the original external caller while being transferred. Sending a cyclic tone or music on hold can be programmed by program [111].
- During a 5-party conference, the user cannot transfer a call.



- **Required System Programming**
  - [005] One-Touch Transfer Using a DSS Button
  - [111] Hold Music Selection
  - [201] Transfer Recall Time
- **Related Feature References**
  - Conference (5-party), Hold, Music on Hold
- **Operating Instructions Reference**
  - 1.5 During Conversation, “Transferring a Call to an Extension (Call Transfer – to Extension)”

### *Call Transfer – to Outside (CO) Line*

Allows an extension user enabled in program [606] to transfer a received call, an intercom call or an outside call, to an external party.



- If a call between 2 external parties is established using this feature, an alarm tone will be sent to both parties 15 seconds before the assigned time limit in program [205]. Also, a ring tone or an alarm tone will be sent to the extension who transferred the call 50 seconds before the timeout. The call will be disconnected at the timeout unless the extension joins the conversation again.
- A single line telephone user cannot transfer a received call to an external party.
- If Music on Hold is enabled, music will be sent to the original external caller while being transferred. Sending a cyclic tone or music on hold can be programmed by program [111].

- To join the conversation again after transferring the call, press the corresponding CO button. A conference call will be established. This feature is not available for a single line telephone.



- **Required System Programming**

- [111] Hold Music Selection

- [205] Outside-to-Outside (CO-to-CO) Line Duration Time Limit

- [606] Call Transfer to an Outside (CO) Line

- **Related Feature Reference**

- Hold, Music on Hold

- **Operating Instructions Reference**

- 1.5 During Conversation, “Transferring a Call to an Outside (CO) Line (Call Transfer – to Outside (CO) Line)”

## Call Waiting

During a conversation, a Call Waiting tone informs an extension user that there is a call waiting. The user can answer the second call by disconnecting the first call or placing it on hold. When Call Waiting is enabled, a Call Waiting tone is sent to the user under the following conditions.

- 1) When an outside call (except a doorphone call) is received, or
- 2) When another extension executes the Busy Station Signaling (BSS) feature.



- For proprietary telephone users, a Call Waiting tone (Tone 1 or Tone 2) can be selected in the Proprietary Telephone Settings. Tone 2 depends on System Programming. Program [423] is for outside calls and program [115] is for intercom calls.

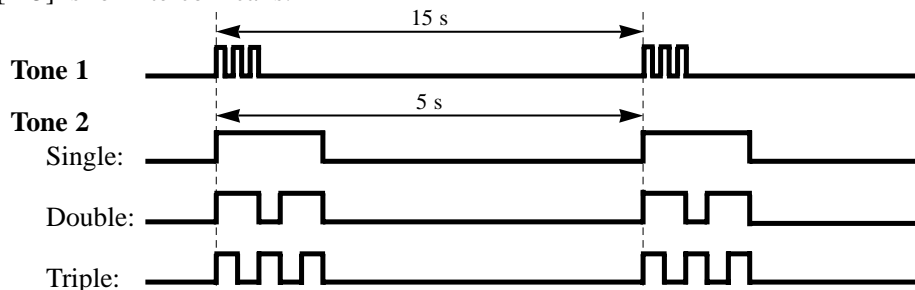

- **Required System Programming**

- [115] Extension Ringing Pattern Selection

- [423] Outside (CO) Line Ringing Pattern Selection

- **Related Feature Reference**

- Hold

- **Operating Instructions References**

- 1.2 Proprietary Telephone Settings, “Customizing Your Telephone Functions”, Call Waiting Tone Selection

- 1.5 During Conversation, “Call Waiting”

## Conference (3-party)

### <Conference>

During a 2-party conversation, an extension user can add a third party to make a 3-party conference. The maximum number of members of a conference can be programmed in program [116].

### <Conference, Unattended>

When a proprietary telephone user is in a 3-party conference with 2 external parties, the user can leave the conference to allow the other 2 parties to continue the conversation. This is called an Unattended Conference. The user may return to the conference, if desired.



- The possible combinations, through System Programming, are 3 extensions, 1 extension and 2 external parties, or 2 extensions and 1 external party.
- When a 2-party call is changed to a 3-party call or vice versa, a confirmation tone is sent to all 3 parties. The tone can be disabled by program [105].
- A 3-party call can also be established by the Executive Busy Override feature.
- The duration of an Unattended Conference can be limited in program [205]. The call is disconnected when the assigned time limit expires unless the extension which leaves the conference returns to it.
- An Unattended Conference can be established when the extension is allowed to transfer a call to an outside (CO) line by program [606].



### • Required System Programming

- [105] Conference Tone
- [116] Conference Pattern Selection
- [205] Outside-to-Outside (CO-to-CO) Line Duration Time Limit
- [606] Call Transfer to an Outside (CO) Line

### • Related Feature References

- Limited Call Duration, Executive Busy Override

### • Operating Instructions References

- 1.2 Proprietary Telephone Settings, “Customizing the Buttons on Your Telephone”, CONF (Conference) Button
- 1.7 Useful Features, “Conference (3-party)”
- 1.7 Useful Features, “Conference, Unattended”

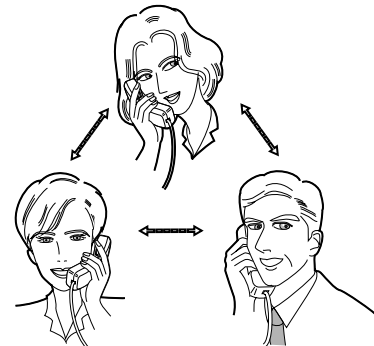

### *Conference (5-party)*

Allows an extension user to establish a 5-party conference when “5 party C-2 E-5” is selected in program [116].



- Up to 2 external parties can participate in a conference call.
- All 5 parties can be extensions.
- Only one 5-party conference can be established at one time.
- When a 5-party conference is established, a confirmation tone is sent to all parties. The tone can be disabled by program [105].
- The Unattended Conference, Executive Busy Override features, and the Call Park feature by another extension are not available during a 5-party conference.



- **Required System Programming**
  - [105] Conference Tone
  - [116] Conference Pattern Selection
- **Related Feature References**
  - Conference (3-party), Call Park, Executive Busy Override
- **Operating Instructions References**
  - 1.2 Proprietary Telephone Settings, “Customizing the Buttons on Your Telephone”, CONF (Conference) Button
  - 1.7 Useful Features, “Conference (5-party)”

### *Data Line Security*

Prevents an extension user from being interrupted by the Call Waiting and Executive Busy Override features. This feature also prevents a ring tone or an alarm tone from being sent when a call is kept waiting longer than a pre-determined time. Data communication devices, such as computers and facsimiles, connected to an extension jack can operate without interruptions.



- **Related Feature References**
  - Call Waiting, Executive Busy Override
- **Operating Instructions Reference**
  - 1.7 Useful Features, “Data Line Security”

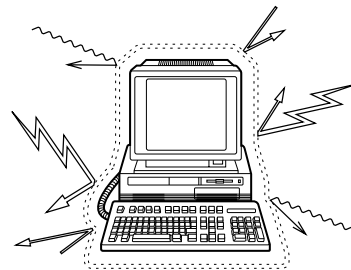

### *Date and Time Setting*

A manager or operator can adjust the current time.



- **Required System Programming**  
[000] Date and Time Setting
- **Operating Instructions Reference**  
1.8 Operator / Manager Service Features, “Date and Time Setting”

### *Direct In Line (DIL)*

Enables an incoming outside call to go directly to a specified extension. This outside (CO) line can be used by multiple extension users to make a call, but can only be used by one extension to receive a call. DIL can have a different destination in the day, night and/or lunch modes.



- If the destination extension is in an extension group which has enabled the Station Hunting feature (Terminate or Circular) in program [100] “Hunting Group Set”, Station Hunting works when the extension is busy.



- **Required System Programming**  
[414]–[416] Outside (CO) Line Mode — Day/Night/Lunch
- **Related Feature References**  
Station Hunting, Time (Day/Night/Lunch) Service

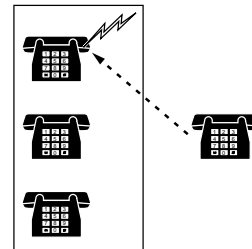

### ***Direct Inward System Access (DISA)***

Allows an outside caller to access specific system features as if the caller is an extension in the system. The caller can have direct access to features such as:

- Placing an incoming call to an extension, extension group or operator. The caller also has the option of dialing the route for an extension using a 1 digit number (DISA built-in auto attendant number) via DISA calls.
- Calling an external party.

One of the following must be selected in program [511] to have direct access to these features:

(1) None Security, (2) Trunk (Outside (CO) Line) Security, or (3) All Security.

**None Security:** Any caller can make outside or intercom calls.

**Trunk Security:** A pre-assigned DISA security code must be entered to make outside calls.

**All Security:** A pre-assigned DISA security code must be entered to make both outside and intercom calls.

This prevents the caller from making unauthorized calls. However, when making an outside call by Call Forwarding – to Outside (CO) Line, the call is allowed (exception).

The DISA feature operates without an optional card installed. If an outgoing message (OGM) which greets a caller and gives information, or fax detection is required, an optional OGM/FAX Detection Card must be installed. The system can detect a FAX (CNG) tone according to program [514]. An OGM can be programmed in program [502] (☞ “Outgoing Message (OGM)” in this section). When a caller reaches a DISA line, a message will greet the caller. Two different DISA messages can be recorded by the operator or manager. For example, one message can be used in day mode and the other in night mode, or they can be used for different outside (CO) lines. If an optional OGM/FAX Detection Card is not installed, the caller will hear a short beep instead of the OGM (Internal DISA).



- “DISA” must be assigned to outside (CO) line(s) as the outside (CO) line mode in programs [414] through [416].
- A DISA call is answered after a ringback tone is returned to the caller after the DISA Delayed Answer Time assigned in program [504] expires. The caller can dial during the message or after the tone.
- This system can store up to 10 programmable DISA built-in auto attendant numbers in program [501]. Each number is 1 digit.
- The DISA built-in auto attendant number may be the same as the first digit of other numbers (extension number, etc.). To avoid confusion, the system waits for the second digit for a preprogrammed amount of time in program [517] (default: 2 seconds). If the timer expires, the system will assume that the first digit is a DISA built-in auto attendant number.
- Only one OGM/FAX Detection Card can be installed .
- The DISA line can be used to make outside calls, if a security code assigned in program [512] (if required) has been dialed.
- This system can store up to 4 programmable DISA security codes. Each code should be different.
- When a wrong DISA security code is entered, 3 beeps will be heard. The call will be disconnected after 3 failed attempts. If you enter a security code a second and third time, dialing \* is not necessary.

- The duration of outside-to-outside (CO-to-CO) line calls can be limited in program [205]. When the specified time expires, both lines are disconnected. A warning tone is sent to both parties 15 seconds before the time-limit.
- To detect the end of an outside-to-outside (CO-to-CO) line call, CPC Signal Detection can be assigned. Programs [420] and [421] are required.



- **Connection Reference**

- 2.15 OGM/FAX Detection Card Installation

- **Required System Programming**

- To enable the DISA feature**

- [414]–[416] Outside (CO) Line Mode — Day/Night/Lunch

- [420] Calling Party Control (CPC) Signal

- [421] CPC Detection for Outgoing Calls

- [500] DISA Incoming Dialing Mode Selection

- [501] DISA Built-in Auto Attendant

- [502] OGM Mode Selection

- [503] FAX Connection

- [506] DISA Busy Mode

- [510] DISA No Dial Mode

- [511] DISA Security Type

- [512] DISA Security Codes

- [513] Cyclic Tone Detection

- [514] FAX Tone Detection

- [516] DISA Incoming Assignment

- [518] DISA Tone Selection after the Security Code

- To set DISA timer values**

- [205] Outside-to-Outside (CO-to-CO) Line Duration Time Limit

- [504] DISA Delayed Answering Time

- [505] DISA Waiting Time after OGM

- [517] DISA AA Wait Time

- [519] DISA OGM Mute Time

- To enable the Intercept Routing feature**

- [408]–[410] Flexible Ringing Assignment — Day/Night/Lunch

- [507] DISA Intercept Mode

- [508] DISA Ringing Time Before Intercept

- [509] DISA Ringing Time After Intercept

- [515] Intercept Time for Internal DISA

- **Related Feature References**

- Intercept Routing, Outgoing Message (OGM), Polarity Reverse Detection, Station Hunting

**DISA Operation**

*Calling an extension by following the outgoing message*

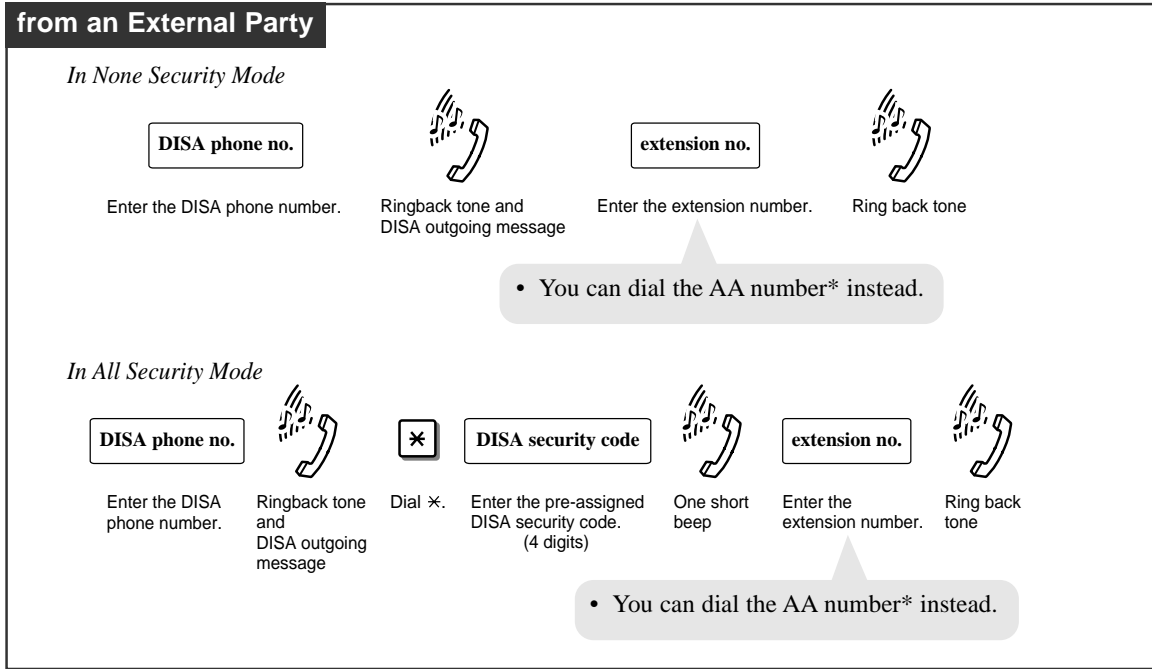

*Calling an extension without an outgoing message (Internal DISA)*

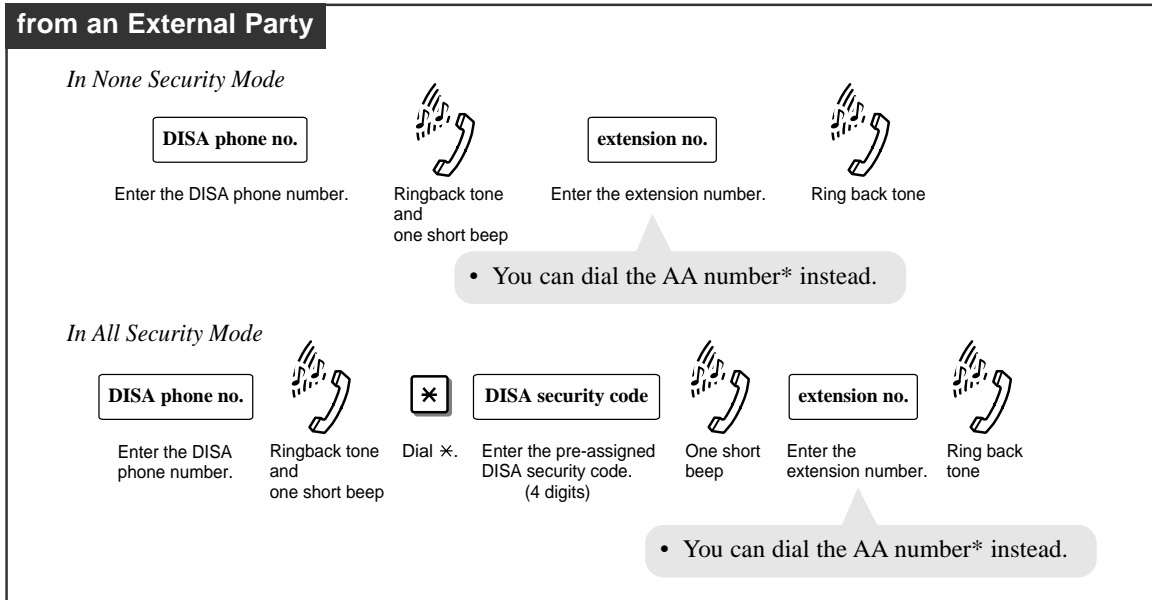



AA number\*: A DISA built-in auto attendant number assigned in program [501] “DISA Built-in Auto Attendant”.



## Calling an external party by following the outgoing message

**from an External Party**



*In None Security Mode*

|  |   |  |   |   |
|--|---|--|---|---|
| <div style="border: 1px solid black; padding: 2px; width: fit-content; margin: 0 auto;">DISA phone no.</div> |  | <div style="border: 1px solid black; padding: 2px; width: fit-content; margin: 0 auto;">line access code</div> |  | <div style="border: 1px solid black; padding: 2px; width: fit-content; margin: 0 auto;">phone no.</div> |
| Enter the DISA phone number.   | Ringback tone and DISA outgoing message   | Enter a line access code (9 or 0, or 81 through 86).   | Dial tone from the Central Office   | Enter the phone number of the external party.   |

*In Trunk Security Mode*

|  |   |   |  |   |  |   |   |
|--|---|---|--|---|--|---|---|
| <div style="border: 1px solid black; padding: 2px; width: fit-content; margin: 0 auto;">DISA phone no.</div> |  | <div style="border: 1px solid black; padding: 2px; width: fit-content; margin: 0 auto;">✖</div> | <div style="border: 1px solid black; padding: 2px; width: fit-content; margin: 0 auto;">DISA security code</div> |  | <div style="border: 1px solid black; padding: 2px; width: fit-content; margin: 0 auto;">line access code</div> |  | <div style="border: 1px solid black; padding: 2px; width: fit-content; margin: 0 auto;">phone no.</div> |
| Enter the DISA phone number.   | Ringback tone and DISA outgoing message   | Dial ✖.   | Enter the pre-assigned DISA security code. (4 digits)  | One short beep  | Enter a line access code (9 or 0, or 81 through 86).   | Dial tone from the Central Office   | Enter the phone number of the external party.   |



*In All Security Mode*

|  |   |   |  |   |  |   |   |
|--|---|---|--|---|--|---|---|
| <div style="border: 1px solid black; padding: 2px; width: fit-content; margin: 0 auto;">DISA phone no.</div> |  | <div style="border: 1px solid black; padding: 2px; width: fit-content; margin: 0 auto;">✖</div> | <div style="border: 1px solid black; padding: 2px; width: fit-content; margin: 0 auto;">DISA security code</div> |  | <div style="border: 1px solid black; padding: 2px; width: fit-content; margin: 0 auto;">line access code</div> |  | <div style="border: 1px solid black; padding: 2px; width: fit-content; margin: 0 auto;">phone no.</div> |
| Enter the DISA phone number.   | Ringback tone and DISA outgoing message   | Dial ✖.   | Enter the pre-assigned DISA security code. (4 digits)  | One short beep  | Enter a line access code (9 or 0, or 81 through 86).   | Dial tone from the Central Office   | Enter the phone number of the external party.   |



## Calling an external party without an outgoing message (Internal DISA)

**from an External Party**



*In None Security Mode*

|  |   |  |   |   |
|--|---|--|---|---|
| <div style="border: 1px solid black; padding: 2px; width: fit-content; margin: 0 auto;">DISA phone no.</div> |  | <div style="border: 1px solid black; padding: 2px; width: fit-content; margin: 0 auto;">line access code</div> |  | <div style="border: 1px solid black; padding: 2px; width: fit-content; margin: 0 auto;">phone no.</div> |
| Enter the DISA phone number.   | Ringback tone and one beep  | Enter a line access code (9 or 0, or 81 through 86).   | Dial tone from the Central Office   | Enter the phone number of the external party.   |

*In Trunk Security Mode*

|  |   |   |  |   |  |   |   |
|--|---|---|--|---|--|---|---|
| <div style="border: 1px solid black; padding: 2px; width: fit-content; margin: 0 auto;">DISA phone no.</div> |  | <div style="border: 1px solid black; padding: 2px; width: fit-content; margin: 0 auto;">✖</div> | <div style="border: 1px solid black; padding: 2px; width: fit-content; margin: 0 auto;">DISA security code</div> |  | <div style="border: 1px solid black; padding: 2px; width: fit-content; margin: 0 auto;">line access code</div> |  | <div style="border: 1px solid black; padding: 2px; width: fit-content; margin: 0 auto;">phone no.</div> |
| Enter the DISA phone number.   | Ringback tone and one short beep  | Dial ✖.   | Enter the pre-assigned DISA security code. (4 digits)  | One short beep  | Enter a line access code (9 or 0, or 81 through 86).   | Dial tone from the Central Office   | Enter the phone number of the external party.   |

*In All Security Mode*

|  |   |   |  |   |  |   |   |
|--|---|---|--|---|--|---|---|
| <div style="border: 1px solid black; padding: 2px; width: fit-content; margin: 0 auto;">DISA phone no.</div> |  | <div style="border: 1px solid black; padding: 2px; width: fit-content; margin: 0 auto;">✖</div> | <div style="border: 1px solid black; padding: 2px; width: fit-content; margin: 0 auto;">DISA security code</div> |  | <div style="border: 1px solid black; padding: 2px; width: fit-content; margin: 0 auto;">line access code</div> |  | <div style="border: 1px solid black; padding: 2px; width: fit-content; margin: 0 auto;">phone no.</div> |
| Enter the DISA phone number.   | Ringback tone and one short beep  | Dial ✖.   | Enter the pre-assigned DISA security code. (4 digits)  | One short beep  | Enter a line access code (9 or 0, or 81 through 86).   | Dial tone from the Central Office   | Enter the phone number of the external party.   |

Flow chart of possible cases and results for DISA calls

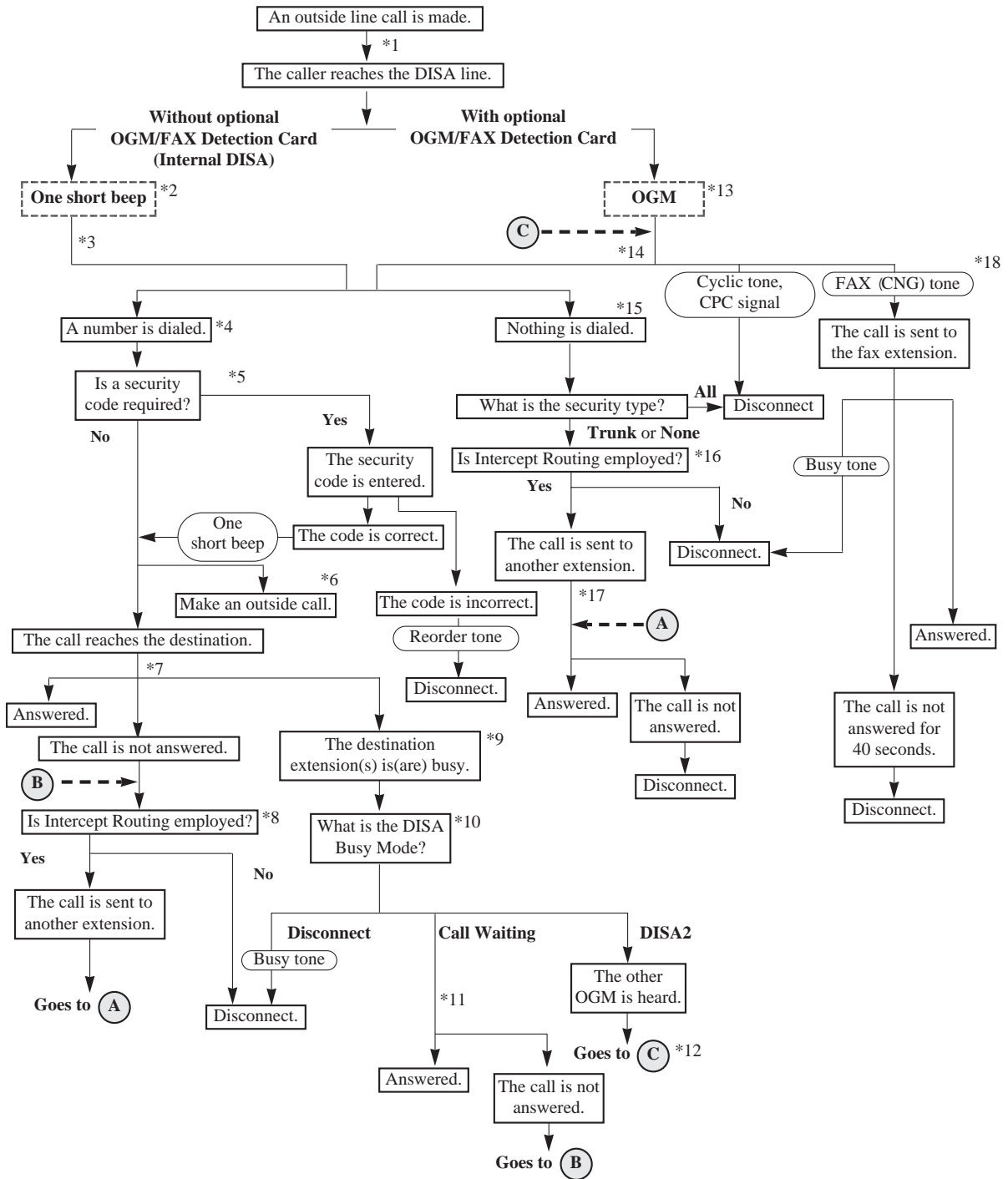

Note: The explanation for \*1 through \*18 is on the next page.

- \*1: The DISA Delayed timer starts. This is the time between a call reaching the system and being received. The time is assigned in program [504].
- \*2: When the assigned time period in program [519] expires, the system sends a short beep to the caller.
- \*3: The Intercept Timer for Internal DISA starts. This is the time the system waits for the number sent by the caller. If nothing is entered by the caller during this time, the system will regard it as “Nothing is dialed.” The time is assigned in program [515].
- \*4: The system can accept the following numbers:
  - **100 through 199** as an extension number.
  - **81 through 86** as an outside (CO) line group line access number.
  - **9** as an automatic line access number when “Without AA” is assigned in program [500]. Even if “With AA” is assigned, 9 is regarded as the automatic line access number if nothing is assigned to “9” in program [501]. In case “9” is assigned as the operator call number in program [121] “Automatic Outside (CO) Line Access Number Selection”, 9 is regarded as the operator call number instead of an automatic line access number.
  - **0** as the operator call number when the operator is assigned in program [008] “Operator Assignment” and “Without AA” is assigned in program [500]. Even if “With AA” is assigned, 0 is regarded as the operator call number if nothing is assigned to “0” in program [501]. If “0” is assigned as an automatic line access number in program [121], 0 is regarded as an automatic line access number instead of the operator call number.
  - **0 through 9** as a built-in auto attendant number when “With AA” is assigned in program [500]. The DISA AA Wait timer starts after receiving the first 1-digit number. If the timer expires, the system will assume that the first digit is an AA number. The time is assigned in program [517].
- \*5: A security code is necessary when program [511] is assigned as follows.
  - **All Security** – the system waits for a security code dialed after “\*”. When the security code matches the one programmed in [512], the system accepts the numbers after the code.
  - **Trunk Security** – the caller can access an outside (CO) line if the security code matches the one programmed in [512]. The caller can access other destinations without the security code.

If the entered number is the same as one of the security codes, a short beep will be heard. The short beep can be disabled by program [518]. If the number is wrong, 3 beeps will be heard. The call will be disconnected after 3 failed attempts.
- \*6: The caller must enter the desired telephone number after hearing a dial tone from the Central Office.
- \*7: The DISA Ring Timer Before Intercept starts. The destination telephone(s) will ring for the time programmed in [508].
- \*8: The system treats the call according to program [507] as follows.
  - **Disconnect** – the call is disconnected.
  - **Intercept** – the call is sent to the extensions programmed in [408]-[410] “Flexible Ringing Assignment – Day/Night/Lunch”.

If the call is still not answered within the time programmed in [509], it will be disconnected.
- \*9: If the destination extension belongs to a hunting group and all extensions in the group are busy, the system will check the DISA Busy Mode. If the destination is a DISA ring group, the DISA Busy Mode will not work for the call. The system regards the call as unanswered.

- 
- \*10: The DISA Busy Mode is selected in program [506]. There are 3 modes as follows.
- **Disconnect** – the caller hears a busy tone and a call is disconnected.
  - **Call Waiting** – the destination extension hears a call waiting tone if they have enabled Call Waiting.
  - **DISA2** – if “MODE2” is assigned in program [502] and a message is recorded in OGM2, the caller will hear the message and the system waits for the new destination.
- \*11: The DISA Ring Timer Before Intercept starts. The destination telephone(s) will ring for the time programmed in [508].
- \*12: In this case, the system disregards the security type and does not accept a line access code. If nothing is recorded in OGM2 or OGM2 is used for another caller, the caller will hear a busy tone and the call is disconnected.
- \*13: The OGM is sent to the caller according to programs [414]–[416] and [502] when the assigned time in program [519] expires. If an OGM is not recorded, the DISA Wait Timer After OGM programmed in [505] starts immediately.  
When the system detects a FAX (CNG) tone while the OGM is being sent, the call is sent to the FAX extension assigned in program [503]. When the system detects a cyclic tone or CPC signal while the OGM is being sent, the call is disconnected.
- \*14: The DISA Wait Timer After OGM starts. The system waits for a number from the caller during the time assigned in program [505]. When the system detects a FAX (CNG) tone during the programmed time, the call is sent to the FAX extension. When the system detects a cyclic tone or CPC signal during the programmed time, the call is disconnected.
- \*15: After the DISA Wait Timer After OGM or the Intercept Timer for Internal DISA expires, the system regards that nothing was dialed.
- \*16: The system treats the call according to program [510] as follows.
- **Disconnect** – the call is disconnected.
  - **Intercept** – the call is sent to the extensions programmed in [408]–[410]. If all extensions are assigned to “Disable”, the call will be disconnected.
- \*17: The DISA Ring Timer After Intercept starts. The destination telephone(s) will ring for the time programmed in [509]. If the call is not answered during the programmed time, the call will be disconnected.
- \*18: The FAX extension assigned in program [503] receives the call. When the extension is busy, the system sends a busy tone to the sending FAX. If the call is not answered after 40 seconds, the call will be disconnected.  
Program [514] determines how many times the FAX (CNG) tone is sent until the system receives it.

### ***Display Contrast Adjustment*** ***(KX-T7330/KX-T7030/KX-T7130/KX-T7033 only)***

Allows a display proprietary telephone user to adjust the display contrast with the CONTRAST selector.



- **Operating Instructions Reference**  
1.2 Proprietary Telephone Settings, “Display Contrast Adjustment”

### ***Distinctive Dial Tones***

An extension user will hear 3 types of dial tone patterns which give information about the features activated on the telephone.

**Dial Tone 1:** This is a normal dial tone. None of the features listed in Dial Tone 2 are activated.



**Dial Tone 2:** Sent when any of the following features are set.

- Absent Message Capability
- Background Music (BGM)  
(for proprietary telephones only)
- Call Forwarding
- Call Pickup Deny
- Data Line Security
- Do Not Disturb (DND)
- Electronic Station Lockout
- Message Waiting  
(for proprietary telephones only)
- Pickup Dialing  
(for single line telephones only)
- Remote Station Lock Control
- Timed Reminder

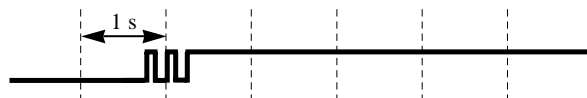

**Dial Tone 3:** Sent when making an Account Code Entry and answering a Timed Reminder call. Also sent when going off-hook with a single line telephone which has a message in a Voice Processing System.



- **Operating Instructions Reference**  
1.7 Useful Features, “Distinctive Dial Tones”

## Do Not Disturb (DND)

### <Do Not Disturb (DND)>

Allows an extension user to prevent other parties from disturbing them. The extension will not receive intercom or outside calls.

### <Do Not Disturb (DND) Override>

Allows an extension user enabled in program [609] to call an extension which has set the Do Not Disturb (DND) feature.



- If your proprietary telephone (PT) is not supplied with the FWD/DND button, it can be assigned to a flexible CO button in the Proprietary Telephone Settings.
- DND does not work for the following calls: Hold recall or Timed Reminder.
- A PT user in the DND mode can answer a call by pressing the corresponding flashing button.
- If the Call Forwarding feature has already been set, setting the DND feature will cancel Call Forwarding.



### • Required System Programming

[609] Do Not Disturb Override

### • Related Feature References

Call Forwarding,  
Timed Reminder

### • Operating Instructions References

1.2 Proprietary Telephone Settings,  
“Customizing the Buttons on  
Your Telephone”,  
FWD/DND (Forward/Do Not Disturb) Button

1.7 Useful Features, “Rejecting Incoming Calls (Do Not Disturb — DND)”

1.7 Useful Features, “Calling an Extension which Denies Receiving Calls  
(Do Not Disturb Override)”

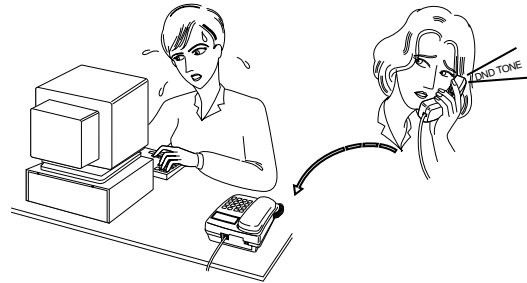

## Door Opener

Up to 4 Door Openers can be connected to the system. The door can be unlocked by a pre-assigned extension users in programs [703]-[705].

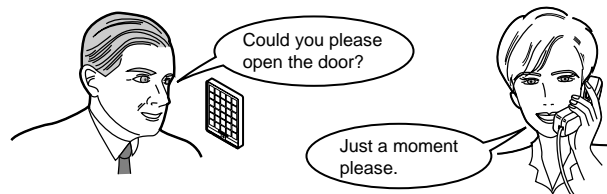

- An optional Doorphone/Door Opener Card must be installed to the system and a user-supplied door opener to the door to be opened. Four openers can be installed.
- The door opener will open the door even if a doorphone is not installed.
- The door opener timer can be modified in program [709].



- **Connection Reference**  
2.16 Doorphone and Door Opener Connection
- **Required System Programming**  
[703]–[705] Door Opener Assignment — Day/Night/Lunch  
[709] Door Opener Time
- **Related Feature Reference**  
Doorphone Call
- **Operating Instructions Reference**  
1.7 Useful Features, “Door Opener”

## *Doorphone Call*

Up to 4 Doorphones (KX-T30865) can be installed. If a visitor presses the doorphone button, a pre-assigned extension user in programs [700]–[702] can answer the call and talk to the visitor. Any extension user can call a doorphone. The doorphones are also used for the Room Monitor feature.



- An optional Doorphone/Door Opener Card must be installed to the system and a doorphone. Four doorphones can be installed.
- Doorphone 1 and 2 cannot be used simultaneously. When one is in use, an extension user cannot have a conversation with the other. Doorphone 3 and 4 are the same.
- An access tone can be programmed in [707] to be sent to a monitored doorphone before room monitoring starts.
- The ring tone from the doorphone call is programmable in [706].



- **Connection Reference**  
2.16 Doorphone and Door Opener Connection
- **Required System Programming**  
[700]–[702] Doorphone Ringing Assignment — Day/Night/Lunch  
[706] Doorphone Ringing/Tone Pattern Selection  
[707] Doorphone Access Tone Selection  
[708] Doorphone Ringing Time
- **Related Feature References**  
Door Opener, Room Monitor
- **Operating Instructions References**  
1.7 Useful Features, “Room Monitor”  
1.7 Useful Features, “Doorphone Call”

## DSS Console

The Direct Station Selection (DSS) Console provides direct access to extensions, a busy lamp display, as well as 16 PF (Programmable Feature) buttons.

The DSS Console must be programmed to work with a proprietary telephone (PT). The jack number of the DSS Console and its associated PT are assigned in programs [003] and [004].

Up to 2 consoles can be installed per system.

If a feature like One-Touch Dialing is assigned to a DSS button or PF button, accessing the feature can be done easily by pressing the corresponding button. This is very useful for an operator or manager. Refer to the Operating Instructions for more details.



- Programming the DSS and PF buttons can be done only from the paired telephone.
- Indicating the Forward (FWD) or Do Not Disturb (DND) status of corresponding extensions using a DSS button indication is programmable in [112].



- **Connection Reference**  
2.8 Extension Connection
- **Required System Programming**  
[003] DSS Console Port Assignment  
[004] Paired Telephone Assignment for DSS Console  
[112] DSS Console Indication Mode
- **Operating Instructions Reference**  
1.9 DSS Console Features

## Emergency Call

Allows an extension user to access a pre-assigned emergency number which can be dialed regardless of any restrictions.



- Up to 5 emergency numbers can be stored.
- An emergency call is allowed even in the following cases;
  - in Account Code Modes (Verify-All, Verify-Toll and Forced modes),
  - in any toll restriction COS number, and
  - in Electronic Station Lockout.



- **Required System Programming**  
[309] Emergency Dial Number Set
- **Related Feature References**  
Account Code Entry, Toll Restriction, Station Lock
- **Operating Instructions Reference**  
1.3 Making Calls, “Making Emergency Calls (Emergency Call)”

## ***Executive Busy Override***

### **<Executive Busy Override – Extension>**

Allows an extension user enabled in program [608] to interrupt an existing intercom call. A 3-party conference will be established.

### **<Executive Busy Override – Outside (CO) Line>**

Allows a proprietary telephone user enabled in program [608] to interrupt an existing outside call or add a third party. A 3-party conference will be established.

### **<Executive Busy Override Deny>**

Allows an extension user to prevent other extension users from interrupting their conversation.



- The Executive Busy Override feature will not work if the extension engaged the conversation has set Executive Busy Override Deny or Data Line Security.
- When a 3-party call is changed to a 2-party call or vice versa, a confirmation tone will be sent to all parties. This tone can be disabled by program [105].



- **Required System Programming**
  - [105] Conference Tone
  - [608] Executive Busy Override
- **Related Feature Reference**
  - Conference (3-party)
- **Operating Instructions References**
  - 1.3 Making Calls, “Interrupting an Existing Call (Executive Busy Override)”
  - 1.3 Making Calls, “Denying ‘Interrupting an Existing Call’ (Executive Busy Override Deny)”

## ***Extension Button Confirmation*** ***(KX-T7330/KX-T7030/KX-T7130/KX-T7033 only)***

Allows a display proprietary telephone user to confirm the values stored in the buttons, such as the REDIAL button or flexible CO button, by pressing the corresponding button while on-hook.



- **Operating Instructions Reference**
  - 1.7 Useful Features “Extension Button Confirmation (KX-T7330/KX-T7030/KX-T7130/KX-T7033 only)”

## *Extension Group*

The system supports 8 extension groups. In an extension group, the following features can be activated.

- **Group Call Pickup:** Any member of an extension group can pick up a call directed to another member in the same group.
- **Paging – Group:** Any member of an extension group can make a voice announcement to another group member.

A hunting group, DISA ring group or UCD group is a specific extension group. The following operation as well as the features above can be activated for a hunting group, DISA ring group or UCD group.

### **Hunting Group**

An extension group enabled in program [100] “Hunting Group Set” will perform the Station Hunting feature. See “Station Hunting” in this section.

### **DISA Ring Group**

All extensions in a DISA ring group assigned as an auto attendant destination in program [501] “DISA Built-in Auto Attendant” will ring simultaneously. Selecting “DISA1” or “DISA2” in programs [414]–[416] “Outside (CO) Line Mode — Day/Night/Lunch” is required.

### **UCD Group**

One extension group assigned as the UCD group in program [520] “UCD Group” can be the destination of incoming outside calls via the UCD feature. Selecting “UCD” in programs [414]–[416] “Outside (CO) Line Mode — Day/Night/Lunch” is required.



- **Required System Program Address**

[600] Extension Group Assignment

- **Related Feature References**

Call Pickup, Direct Inward System Access (DISA), Paging, Station Hunting, Uniform Call Distribution (UCD)

## *Extension Password / System Password*

The extension password assigned by the manager (extension jack 01) to each extension can be used for the Toll Restriction Override by Extension Password and Walking COS features. The system password is used for entering System Programming and also before assigning the extension password.



- **Required System Programming**

[002] System Password

- **Related Feature References**

Toll Restriction Override by Extension Password, Walking COS

- **Operating Instructions Reference**

1.8 Operator / Manager Service Features, “Extension Password Set (Manager only)”

## External Feature Access

Allows an extension user to access special features (e.g. Call Waiting) offered by the Central Office or host PBX. This is done by placing the current call on hold and sending a flash signal using either the FLASH button or the feature number. This feature is effective only during an outside call.



- When “MODE2” is selected in program [110] and the FLASH button is pressed for longer than the time programmed in [418], this feature will not work.
- The flash time must be assigned in program [418] as required by the host PBX or outside (CO) line.



- **Required System Programming**
  - [110] Flash Key Mode
  - [418] Flash Time
- **Related Feature References**
  - Flash, Host PBX Access
- **Operating Instructions Reference**
  - 1.7 Useful Features, “External feature Access”

## Flash

The FLASH button is used to allow a proprietary telephone user to disconnect the current call and originate another call without hanging up. This is activated when “MODE2” is selected in program [110] and the FLASH button is pressed for longer than the time programmed in [418]. When “MODE1” is selected in program [110], the FLASH button can be used to access features of the Central Office or host PBX (External Feature Access). It is performed by putting the current party on hold and sending a flash signal while having an outside call.



- Assigning the External Feature Access feature to any flexible button is useful when “MODE 2” was selected in program [110]. This can be done from any extension by assigning the FLASH button to a One-Touch Dialing button (☞ Operating Instructions, 1.2 Proprietary Telephone Settings, “Customizing the Buttons on Your Telephone”, One-Touch Access for System Features). When the assigned button is pressed, a flash signal is sent during the programmed time in [418].



- **Required System Program Address**
  - [110] Flash Key Mode
  - [418] Flash Time
- **Operating Instructions Reference**
  - 1.7 Useful Features, “External Feature Access”

### Flexible Buttons

A proprietary telephone (PT) user can change the flexible buttons on the telephone and DSS console to certain function buttons. For example, if the telephone has more CO buttons than available outside (CO) lines, the unused CO buttons may be changed to One-Touch Dialing buttons, etc.

The 4 types of flexible buttons are as follows:

- **Flexible CO Buttons** (located on a PT only)
- **Flexible DSS Buttons** (located on a DSS Console only)
- **Programmable Feature (PF) Buttons** (located on a PT and DSS Console)
- **Flexible MESSAGE Buttons** (located on a PT except for the KX-T7055)

Check the required operation first. If the telephone is not provided with the button, assigning the button can be performed in the Proprietary Telephone Settings.

| Function                         | Programmable Button |     |    |         |
|----------------------------------|---------------------|-----|----|---------|
|                                  | CO                  | DSS | PF | MESSAGE |
| DSS (Direct Station Selection)   | ✓                   | ✓   |    | ✓       |
| One-Touch Dialing                | ✓                   | ✓   | ✓  | ✓       |
| CONF (Conference)                | ✓                   |     |    |         |
| FWD/DND (Forward/Do Not Disturb) | ✓                   |     |    |         |
| SAVE                             | ✓                   |     |    |         |
| Log-In/Log-Out                   | ✓                   |     |    |         |
| Single-CO (S-CO)                 | ✓                   |     |    |         |
| Other CO (O-CO)                  | ✓                   |     |    |         |
| Group-CO (G-CO)                  | ✓                   |     |    |         |
| MESSAGE (Message Waiting)        |                     |     |    | ✓       |
| Day                              |                     | ✓   |    |         |
| Night                            |                     | ✓   |    |         |
| Lunch                            |                     | ✓   |    |         |
| Station Lock                     |                     | ✓   |    |         |

“✓” indicates that the feature is available.



- **Operating Instructions Reference**  
1.2 Proprietary Telephone Settings, “Customizing the Buttons on Your Telephone”

## ***Handset/Headset Selection***

***(KX-T7330/KX-T7030/KX-T7130/KX-T7033 only)***

The system supports the use of headsets with proprietary telephones. Switch the selection mode before using the headset (optional).



- **Operating Instructions Reference**  
1.2 Proprietary Telephone Settings, “When Using the Headset”

## ***Handsfree Answerback***

Allows a proprietary telephone with a speakerphone to answer an intercom call without lifting the handset. This feature performed by pressing the AUTO ANSWER/MUTE or AUTO ANS/MUTE button.



- This feature does not work for incoming outside calls or doorphone calls.



- **Operating Instructions Reference**  
1.4 Receiving Calls, “Handsfree Answerback”

## ***Handsfree Operation***

Allows a proprietary telephone user to dial and talk to the other party without lifting the handset. Pressing one of the following buttons activates the handsfree mode when the SP-PHONE/MONITOR button indicator is off:

**SP-PHONE button, MONITOR button, INTERCOM button, or CO button.**



- The KX-T7350, the KX-T7050 and the KX-T7055 can perform handsfree dialing operations, etc., but cannot have a handsfree conversation.



- **Operating Instructions Reference**  
1.3 Making Calls, “Handsfree Operation”

## Hold

### <Call Hold>

Allows an extension user to place an intercom and/or outside call. The held call can be retrieved by the user who held it, or by any other extension (Call Hold Retrieve).

With a single line telephone (SLT), either one outside or intercom call can be held at one time. If an SLT user want to hold both calls, use the Call Park feature. An SLT user can select how to operate the Call Hold feature by program [104].

### <Exclusive Hold>

Allows an proprietary telephone user to prevent other extension users from retrieving their held call. Only the user who held the call can retrieve it. This feature is not available for an SLT.



- Only one intercom call can be placed on hold. For a proprietary telephone, outside calls and one intercom call can be placed on hold at the same time.
- If a held call is not retrieved within the assigned time in program [200], the extension user who held it will hear a ring tone or an alarm tone. If the user is on-hook and their SP-PHONE/MONITOR button indicator is off, the phone will ring (Hold Recall). If the user is off-hook or in the handsfree mode, an alarm tone will be sent to the built-in speaker of a proprietary telephone or the handset receiver of a single line telephone at 15-second interval (Hold Alarm).  
If “Disable” is selected in program [200], nothing will be heard.
- If a held outside call is not answered within thirty minutes, it will be automatically disconnected.
- For outside calls, music is sent to the external party on hold, if available (Music on Hold).
- During a 5-party conference, the Hold feature cannot be activated.



#### • Required System Programming

[104] Hold Mode Selection

[200] Hold Recall Time

#### • Related Feature References

Call Park, Music on Hold, Hookswitch Flash

#### • Operating Instructions References

1.5 During a Conversation, “Placing a Call on Hold (Call Hold)”

1.5 During a Conversation, “Placing a Call on Hold Exclusively (Exclusive Hold)”

1.5 During a Conversation, “Retrieving a Call on Hold (Call Hold Retrieve)”

### Hookswitch Flash

Flashing the hookswitch is used to allow a single line telephone user to hold a call for transferring or holding, if the flash time is within the assigned time in program [207]. The procedure to transfer a call or hold is determined in program [104] “Hold Mode Selection”. Flashing the hookswitch can be also used to disconnect a call, if the flash time is more than the assigned time in program [207].



- If “MODE 1” was selected in program [207], the system will recognize flashing the hookswitch as hooking, while a busy tone or reorder tone is sent or during a conversation. The system will recognize as 1 being dialed in the pulse mode, while a dial tone is sent. The system can refuse receiving a pulse signal by selecting “Disable” in program [614]. Therefore, even if the hookswitch is flashed during a dial tone, the system will regard it as hooking.



- **Required System Programming**  
[207] Hookswitch Flash Timing Range Selection  
[614] Internal Pulse Detection

### Host PBX Access

The system may be installed behind an existing host PBX. This is performed by connecting a line from the host to an outside (CO) line in the system.



- A Host PBX Access code assigned in program [403] is required to access an outside (CO) line of the host PBX.
- Access to the host PBX during a conversation is also possible (External Feature Access).



- **Required System Programming**  
[403] Host PBX Access Codes  
[417] Pause Time

- **Related Feature Reference**  
External Feature Access

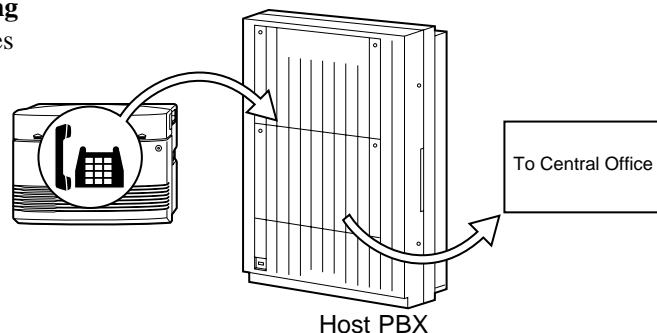

## *Intercept Routing*

Provides automatic redirection of incoming outside calls via the DISA or UCD feature. The Intercept Routing feature works in the following 2 cases.

- 1) When nothing is dialed after a dial tone or OGM is sent to the caller. (The DISA feature only)
- 2) When the call is not answered within a programmed time. This is called Intercept Routing – No Answer (IRNA).



- **Required System Programming**

- [408]–[410] Flexible Ringing Assignment — Day/Night/Lunch
- [507] DISA Intercept Mode
- [508] DISA Ringing Time Before Intercept
- [509] DISA Ringing Time After Intercept
- [510] DISA No Dial Mode
- [523] UCD Busy Mode
- [524] UCD Intercept Mode
- [525] UCD Ringing Time Before Intercept
- [526] UCD Ringing Time After Intercept

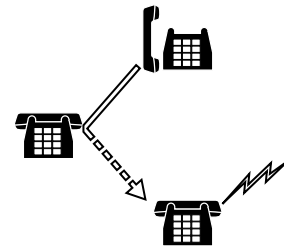

- **Related Feature References**

Direct Inward System Access (DISA), Uniform Call Distribution (UCD)

## *Intercom Calling*

Allows an extension user to make a call to another extension.



- An extension number and a name can be assigned in programs [009] and [604]. If assigned, they will be shown on the display proprietary telephone during an intercom call.
- The DSS buttons permit a proprietary telephone user one-touch access to an extension. The DSS button can be assigned to a flexible CO button in the Proprietary Telephone Settings. The DSS buttons on the DSS console can also be used.



- **Required System Programming**

- [009] Extension Number Assignment
- [604] Extension Name Setting

- **Operating Instructions References**

- 1.2 Proprietary Telephone Settings, “Customizing the Buttons on Your Telephone”, DSS (Direct Station Selection) Button
- 1.3 Making Calls, “Intercom Calling”
- 1.9 DSS Console Features, “Initial Settings”, Extension Number Assignment

## *Language Selection*

The selected language in program [615] is shown on the LCD display of a proprietary telephone during operation and Proprietary Telephone Settings, but not used during System Programming.



- **Required System Programming**  
[615] LCD Language Assignment

## *Limited Call Duration*

The system disconnects 2 types of outside outgoing calls when a specific timer expires. One is a call with an external party. The other is an outside-to-outside (CO-to-CO) call using the Call Forwarding – to Outside (CO) Line, Call Transfer – to Outside (CO) Line, Unattended Conference feature, or the DISA feature. Limiting the time of the call can be assigned through System Programming.



- An alarm tone will be sent to both parties 15 seconds before the assigned time limit.



- **Required System Programming**
  - [205] Outside-to-Outside (CO-to-CO) Line Duration Time Limit
  - [212] Outside (CO) Line Duration Time Limit
  - [613] Outside (CO) Line Duration Time Limit Selection
- **Related Feature References**
  - Call Forwarding – to Outside (CO) Line, Call Transfer – to Outside (CO) Line, Conference (3-party), Direct Inward System Access (DISA)

## Line Access Buttons

A proprietary telephone (PT) user must assign one of the following 3 types of CO buttons to flexible CO buttons in the Proprietary Telephone Settings. This allows making or receiving outside calls. The default setting for the flexible CO buttons (CO 1 – CO 6) are Single-CO (S-CO) buttons. CO 1 corresponds to outside (CO) line 1, CO 2 corresponds to outside (CO) line 2, etc.

### <Group-CO (G-CO) Button>

Receiving or making outside calls is on an outside (CO) line group basis. The outside (CO) line group is assigned in program [404]. Any incoming call from any outside (CO) line in the outside (CO) line group arrives at the G-CO button. To make an outside call, the user can access an idle outside (CO) line in the group by simply pressing the assigned G-CO button.

### <Single-CO (S-CO) Button>

Receiving or making outside calls is done using a specific outside (CO) line. An incoming call from the specific outside (CO) line arrives at the S-CO button. To make an outside call, the user can access the specific outside (CO) line by simply pressing the assigned S-CO button.

### <Other-CO (O-CO) Button>

Outside (CO) lines, which are not assigned to an S-CO or G-CO button, can be assigned to a flexible CO button as the O-CO button. An incoming call on an outside (CO) lines arrives at the O-CO. To make an outside call, the user simply presses the assigned O-CO button.



- The same outside (CO) line group can be assigned to more than one G-CO button on the same PT.
- The same line can be assigned to an S-CO button and G-CO button. The S-CO button has priority.
- Immediate, delayed, no ringing or no incoming calls (disable) can be selected by programs [405] through [413] on an extension-outside (CO) line basis.
- A ringing pattern can be selected for each outside (CO) line by program [423].



### • Required System Programming

- [400] Outside (CO) Line Connection Assignment
- [404] Outside (CO) Line Group Assignment
- [405]–[407] Flexible Outward Dialing Assignment — Day/Night/Lunch
- [408]–[410] Flexible Ringing Assignment — Day/Night/Lunch
- [411]–[413] Delayed Ringing Assignment — Day/Night/Lunch
- [423] Outside (CO) Line Ringing Pattern Selection

### • Related Feature References

Ringing Pattern Selection, Outside Calling, Receiving Calls

### • Operating Instructions Reference

1.2 Proprietary Telephone Settings, “Customizing the Buttons on Your Telephone”,  
Line Access Buttons

## Log-In/Log-Out

Allows an extension user to join (Log-In) or leave (Log-Out) a hunting, DISA ring or UCD group temporarily. Extensions in the log-out mode will not receive calls by Station Hunting, DISA or UCD but will receive other calls, not like the Do Not Disturb (DND) feature. The Log-In/Log-Out button can be assigned to a flexible button in the Proprietary Telephone Settings. The lighting patterns of the Log-In/Log-Out button on a proprietary telephone and status are as follows.

Off: Log-In mode  
Red: Log-Out mode



- There should be at least one extension that is in the Log-In mode in a group.



- **Related Feature References**

Direct Inward System Access (DISA),  
Extension Group,  
Station Hunting, Uniform Call Distribution (UCD)

- **Operating Instructions References**

- 1.2 Proprietary Telephone Settings, “Customizing the Buttons on Your Telephone”, Log-In/Log-Out Button
- 1.7 Useful Features, “Joining or Leaving a Call Distribution Group (Log-In/Log-Out)”

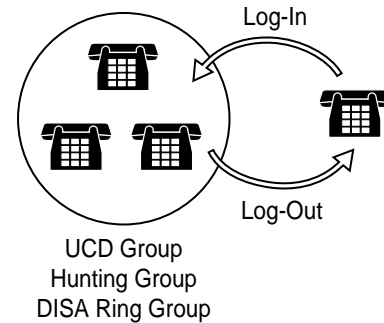

## Message Waiting

Allows an extension user to notify the called extension of a message waiting when the called extension is busy or does not answer the call. Only a proprietary telephone user with a MESSAGE button can know there is a message waiting if the LED on the MESSAGE button lights red. Pressing the lit MESSAGE button can call back the called party. The messages which are stored in the mailbox of the Voice Processing System can also be heard by following the Voice Mail prompts after pressing the lit MESSAGE button (Voice Mail Integration).



- This feature is not available for a proprietary telephone which does not have a MESSAGE button, such as the KX-T7055.
- Canceling the message can be performed from the extension sending it or from the extension receiving it.
- Each extension can have a maximum of 8 simultaneous messages.
- Messages are always left at the original extension. They cannot be sent to a Call Forwarding or Station Hunting destination.



- **Operating Instructions References**

- 1.2 Proprietary Telephone Settings, “Customizing the Buttons on Your Telephone”, Restoring the MESSAGE button
- 1.7 Useful Features, “Leaving a Message Notification (Message Waiting)”
- 1.7 Useful Features, “Voice Mail Integration”

### ***Microphone Mute***

Allows a proprietary telephone user to turn off the microphone for privacy.



- The user's voice will only be muted during a handsfree conversation. The user can hear the other party's voice during Microphone Mute.



- **Operating Instructions Reference**  
1.5 During a Conversation, "Turning off the Microphone (Microphone Mute)"

### ***Music on Hold / Background Music (BGM)***

While an external party is on hold, music is automatically generated.



- Operations such as Call Hold and Call Transfer activate Music on Hold.
- A user-supplied external music source, such as a radio, must be connected to the system when "External" is selected in program [111]. One external music source can be connected to the system. The music source is used for Music on Hold and/or BGM.
- When "Tone" is selected in program [111], the cyclic tone is used only for Music on Hold and the external music source is used for BGM.



- **Connection Reference**  
2.10 External Music Connection
- **Required System Programming**  
[111] Hold Music Selection
- **Related Feature References**  
Hold, Call Transfer – to Extension, Call Transfer – to Outside (CO) line, Uniform Call Distribution (UCD)
- **Operating Instructions Reference**  
1.7 Useful Features, "Turning on the Background Music (BGM)"

### ***One-Touch Dialing***

Allows a proprietary telephone user one-touch access to a desired party or system feature. This is done by storing an extension number, telephone number or a feature number (up to 16 digits) in a One-Touch Dialing button. One-Touch Dialing buttons can be assigned to flexible buttons in the Proprietary Telephone Settings.



- An account code can be stored into a One-Touch Dialing button.
- A number consisting of 17 digits or more can be stored by dividing it and storing it in 2 One-Touch Dialing buttons.



- **Operating Instructions References**

- 1.2 Proprietary Telephone Settings, “Customizing the Buttons on Your Telephone”  
One-Touch Dialing button
- 1.3 Making Calls, “Dialing by Simply Pressing a Button (One-Touch Dialing)”
- 1.9 DSS Console Features, “Initial Settings”
- 1.9 DSS Console Features, “One-Touch Dialing”
- 1.9 DSS Console Features, “One-Touch Access for System Features”

## ***Operator / Manager Extension***

The system supports one operator. Any extension can be designated as an operator in program [008]. Extension jack 01 is the system manager extension. The extension assigned as an operator or manager has the ability to perform the following operations.

- Setting the Date and Time
- Canceling the Electronic Station Lockout
- Setting/Canceling the Remote Station Lock
- Setting/Canceling/Confirming the Timed Reminder (Wake-up Call) Remotely
- Recording and Playing the Outgoing Message
- Changing the Day/Night/Lunch Mode

The manager extension can also perform System Programming and the following operation.

- Setting the Extension Password



- **Required System Programming**

- [008] Operator Assignment

- **Operating Instructions Reference**

- 1.8 Operator / Manager Service Features

## ***Operator Call***

Allows an extension user to call an operator within the system by dialing the feature number assigned in program [121]. One extension can be assigned as the operator in program [008].



- If an operator is not assigned, this feature is not available and a reorder tone will be heard.
- Every extension user can reach the operator just by dialing the operator call number (0 or 9) assigned in program [121] “Automatic Outside (CO) Line Access Number Selection”.



- **Required System Programming**

- [008] Operator Assignment

- [121] Automatic Outside (CO) Line Access Number Selection

- **Related Feature Reference**

- Automatic Outside (CO) Line Access Number

- **Operating Instructions Reference**

- 1.3 Making Calls, “Calling an Operator (Operator Call)”

## Outgoing Message (OGM)

Allows the extension assigned as an operator or manager to record up to 2 outgoing voice messages (maximum 30 seconds each). This message is played when a caller accesses the DISA or UCD feature. An optional OGM/FAX Detection Card is required to program the OGM.

The following are some examples of OGM and flow chart.

### Case 1: Receives 2 calls at a time – OGM for DISA. (Do not want customers to be kept waiting.)

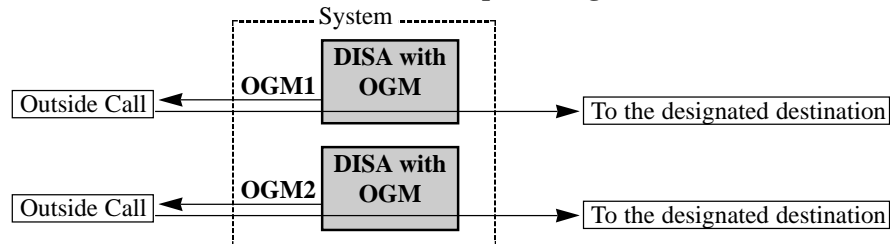

OGM1: “This is A company. For the sales division, press 1. For the service division, press 2. To call the operator, press 0.”

OGM2: Same as OGM 1

Required Settings: [502] “MODE1”  
[414]-[416] “DISA1”

### Case 2: Uses the OGM in the day, night and lunch modes – OGM for DISA.

(In the day mode)

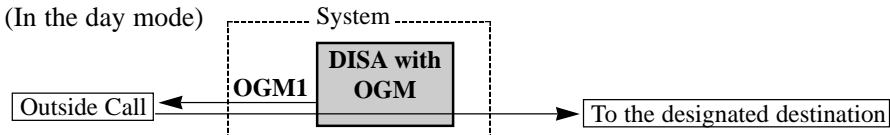

(In the night mode)

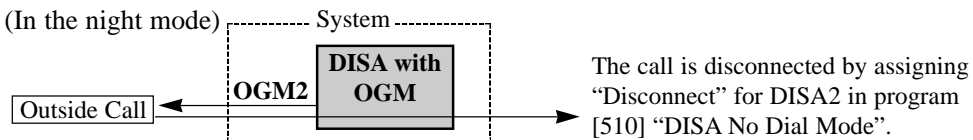

OGM1: “This is A company. For the sales division, press 1. For the service division, press 2. To call the operator, press 0.”

OGM2: “We are sorry but our office is closed for the day.”

Required Settings: [502] “MODE2”  
[414]-[416] “DISA1” for OGM1, “DISA2” for OGM2

### Case 3: Uses a different OGM for outside (CO) lines – OGM for DISA.

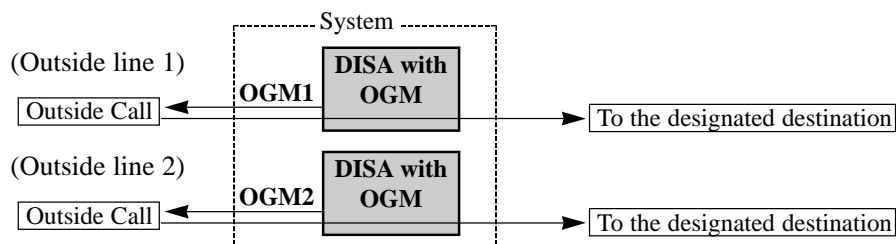

- OGM1: “This is A company. For the sales division, press 1. For the service division, press 2. To call the operator, press 0.”
- OGM2: “This is B company. To contact Mr. A, press 101. To contact Mr. B, press 102.”
- Required Settings: [502] “MODE2”  
 [414]-[416] “DISA1” for the A company outside (CO) line(s).  
 “DISA2” for the B company outside (CO) line(s).

**Case 4: Uses a different OGM when the line is busy – OGM for DISA.**

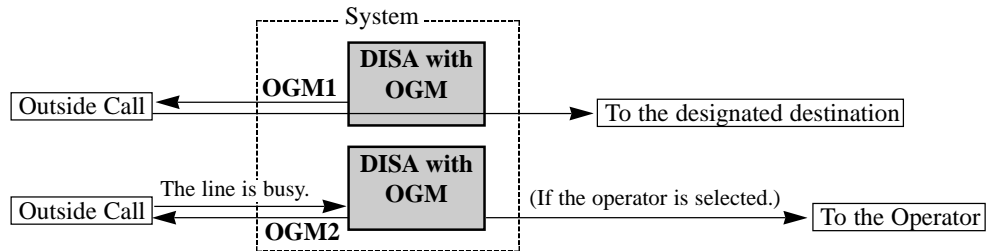

- OGM1: “This is A company. For the sales division, press 1. For the service division, press 2. To call the operator, press 0.”
- OGM2: “We are sorry. The line is currently busy. If you want to call the operator, press 0.”
- Required Settings: [502] “MODE2”  
 [414]-[416] “DISA1”  
 [506] “DISA2”

**Case 5: Distributes calls to the UCD group – OGM for UCD.**

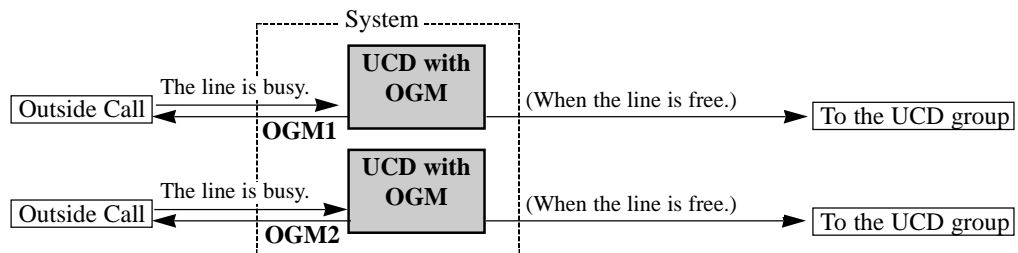

- OGM1: “We are sorry. The line is currently busy. Please hold.”
- OGM2: Same as OGM1
- Required Settings: [502] “MODE3”  
 [414]-[416] “UCD”

**Case 6: Disconnects a call after the OGM – OGM for UCD.**

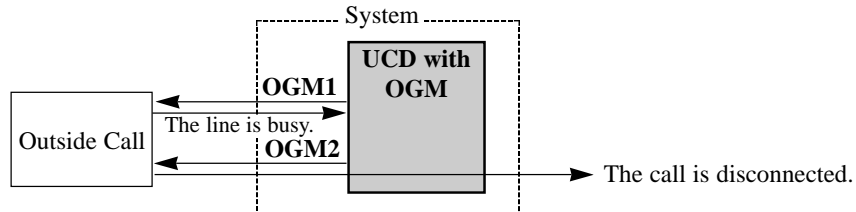

- OGM1: “We are sorry. The line is currently busy. Please hold.”
- OGM2: “We are sorry. The line is currently busy. Please call back later.”
- Required Settings: [502] “MODE4”  
 [414]-[416] “UCD”

**Case 7: Uses the DISA or UCD feature for outside (CO) lines  
– OGM for DISA and UCD.**

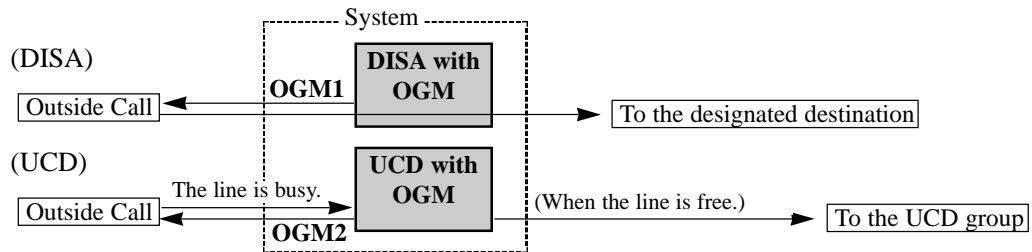

OGM1: “This is A company. For the sales division, press 1. For the service division, press 2. To call the operator, press 0.” (DISA message)

OGM2: “We are sorry. The line is currently busy Please hold.” (UCD message)

Required Settings: [502] “MODE5”

[414]–[416] “DISA1” for outside (CO) line(s) which use the DISA feature

“UCD” for outside (CO) line(s) which use the UCD feature



- An optional OGM/FAX Detection Card is required to program the OGM.



- **Connection Reference**

2.15 OGM/FAX Detection Card Installation

- **Required System Programming**

[414]–[416] Outside (CO) Line Mode — Day/Night/Lunch

[502] OGM Selection

[506] DISA Busy Mode

- **Related Feature References**

Direct Inward System Access (DISA), Uniform Call Distribution (UCD)

- **Operating Instructions Reference**

1.8 Operator / Manager Service Features, “Outgoing Message (OGM)”

## Outside Calling

Allows an extension user to make a call to an external party by using one of the following line access methods.

### <Automatic Line Access>

Allows an extension user to select an available outside (CO) line automatically from the assigned lines in program [419] by pressing the Automatic Line Access number (0 or 9). For a proprietary telephone, a Line Access Button assignment (S-CO, G-CO, O-CO) in the Proprietary Telephone Settings is required. If Idle Line Preference is set on the telephone in the Proprietary Telephone Settings, the user can access an idle line only by going off-hook.

### <Individual Line Access>

Allows a proprietary telephone user to select the desired outside (CO) line by pressing the CO button assigned as the S-CO button. A Line Access Button assignment (S-CO) is required before use.

### <Outside (CO) Line Group Access>

Allows an extension user to select an idle line within a designated outside (CO) line group. An outside (CO) line group is assigned in program [404]. To specify an outside (CO) line group, dial the feature number “8” and the desired outside (CO) line group number (1 through 6). A proprietary telephone user can also specify an outside (CO) line group by pressing a G-CO button. A Line Access Button assignment (G-CO) is required before use. If Idle Line Preference is set on the telephone in the Proprietary Telephone Settings, the user can access an idle line only by going off-hook.



- Each extension requires System Programming to access outside (CO) lines.
- After an outside (CO) line is seized, the system waits for the assigned time in program [206] before dialing.



### • Required System Programming

- [206] Dialing Start Time
- [400] Outside (CO) Line Connection Assignment
- [404] Outside (CO) Line Group Assignment
- [405]–[407] Flexible Outward Dialing Assignment — Day/Night/Lunch
- [419] Automatic Designated Outside (CO) Line Access

### • Related Feature References

- Automatic Outside (CO) Line Access Number
- Preferred Line Assignment — Outgoing, Line Access Buttons

### • Operating Instructions References

- 1.2 Proprietary Telephone Settings, “Customizing Your Telephone Functions”, Preferred Line Assignment — Outgoing
- 1.2 Proprietary Telephone Settings, “Customizing the Buttons on Your Telephone”, Line Access Buttons
- 1.3 Making Calls, “Outside Calling”

## Outside (CO) Line Ringing Selection

When an outside call is received at an extension, the user can select whether their extension will ring or not.



- Select “Enable” in programs [408]–[410].



- **Required System Programming**  
[408]–[410] “Flexible Ringing Assignment — Day/Night/Lunch
- **Operating Instructions Reference**  
1.2 Proprietary Telephone Settings, “Customizing Your Telephone Functions”,  
Outside (CO) Line Ringing Selection

## Paging

Allows an extension user to make a voice announcement to several people at the same time. The message is announced over the built-in speakers of proprietary telephones and/or the external pager. The paged person can answer the page (Answering a Page) from any extension within the system. The following types are available.

- All Extensions:** Makes a voice announcement to all extensions over the built-in speakers of proprietary telephones.
- Group:** Makes a voice announcement to the designated extension group over the built-in speakers of proprietary telephones. An extension group is assigned in program [600] “Extension Group Assignment”.
- External:** Makes a voice announcement over the external pager.
- All Extensions & External:** Makes a voice announcement to all extensions over the built-in speakers of proprietary telephones and the external pager.



- An extension user can also transfer a call after paging (Paging and Transfer) or denying to be paged (Paging Deny).
- An external pager (user-supplied) must be connected beforehand. One external pager can be connected to the system.
- A confirmation tone is sent to the extensions before the voice announcement or answering.
- A confirmation tone is sent to the external pager before the voice announcement. The tone to the external pager can be disabled in program [106].
- An extension which has set the Do Not Disturb (DND) or Paging Deny feature, or is in use cannot be paged.



- **Connection Reference**  
2.9 External Pager (Paging Equipment) Connection
- **Required System Programming**  
[106] External Paging Access Tone
- **Related Feature References**  
Extension Group, Do Not Disturb (DND)
- **Operating Instructions Reference**  
1.5 During a Conversation, “Paging”

## *Paralleled Telephone Connection*

Any analog proprietary telephone can be connected in parallel with a single line device, such as a single line telephone, facsimile and data terminal.



- System Programming is required.



- **Connection Reference**  
2.11 Paralleled Telephone Connection
- **Required System Programming**  
[610] Paralleled Telephone Connection
- **Related Feature Reference**  
Power Failure Transfer
- **Operating Instructions Reference**  
1.7 Useful Features, “Parallel Connection of a Proprietary Telephone and Single Line Telephone (Paralleled Telephone Connection)”

## *Personal Speed Dialing*

Allows an extension user to store up to 10 speed dialing numbers (0 through 9) with a maximum of 16 digits per number. An extension number, telephone number or feature number can be stored. For example, storing extension numbers for each room in a house can be useful. (1 = Living Room, 2 = Kitchen, etc.) To make a call, dial # and the number.



- Proprietary telephone users cannot use this feature if One-Touch Dialing buttons are assigned to PF buttons. If the user assign a personal speed dialing number, the number stored in the One-Touch Dialing button will be overwritten and vice versa. PF Buttons F1 through F10 correspond to the speed dialing numbers as follows.

|        |         |
|--------|---------|
| F1 — 0 | F6 — 5  |
| F2 — 1 | F7 — 6  |
| F3 — 2 | F8 — 7  |
| F4 — 3 | F9 — 8  |
| F5 — 4 | F10 — 9 |

- A rotary telephone user cannot use this feature.



- **Operating Instructions References**  
1.3 Making Call, “Dialing with Personal Speed Dialing (Personal Speed Dialing)”

### *Pickup Dialing*

Allows a single line telephone user to make an outgoing call by going off-hook, if the user has stored the telephone number (up to 32 digits) beforehand. This feature is also known as Hot Line.



- A rotary telephone cannot program this feature.
- The user can set and cancel this feature.
- If the feature is activated and the user goes off-hook, a dial tone will be generated for the delay time assigned in program [203] and then dialing will start. During the delay time, the user can dial another party overriding the Pickup Dialing function.



- **Required System Programming**  
[203] Pickup Dial Delay Time
- **Operating Instructions Reference**  
1.3 Making Call, “Dialing by Simply Going Off-Hook (Pickup Dialing)”

### *Polarity Reverse Detection*

The circuit in the system can detect an outside (CO) line polarity reverse signal from the Central Office when trying to make an outside call. This detects the start (a called party goes off-hook) and end (the called party goes on-hook) of an outgoing outside call. The conversation time can be verified on the SMDR printout using this feature.

When an outside call is received, the circuit can also detect the polarity reverse signal before ringing.



- **Required System Programming**  
[424] Reverse (Polarity) Circuit Assignment
- **Related Feature Reference**  
Station Message Detail Recording (SMDR)

## Power Failure Transfer

During a power failure, specific extension telephones are automatically connected to specific outside (CO) lines. This provides outside (CO) line conversations between the following extensions and outside (CO) lines.

Outside (CO) line 1 : extension jack 01

Outside (CO) line 4 : extension jack 09

A single line telephone (SLT) can work in case of a power failure. Connect an SLT to the above extension jack. For more information, refer to the Operating Instructions.



- All other conversations, except the above combinations, are disconnected during a power failure.
- Only an outside (CO) line can have a conversation. All other features do not work.
- We recommend connecting a single line telephone (SLT) in parallel at extension jacks 01 and 09, so that an SLT can be used during a power failure.



- **Connection Reference**  
2.19 Auxiliary Connection for Power Failure Transfer
- **Related Feature Reference**  
Paralleled Telephone Connection
- **Operating Instructions Reference**  
1.7 Useful Features, “Power Failure Transfer”

## Preferred Line Assignment — Incoming

A proprietary telephone user can select the method to answer incoming outside calls from the following 3 line preferences. System Programming and Proprietary Telephone Settings are required.

**No Line Preference:** When an incoming call is received, the extension user must go off-hook and then press the flashing CO button.

**Prime Line Preference:** When incoming calls are received at the same time, the user can receive the call on the preferred outside (CO) line by only going off-hook.

**Ringling Line Preference:** When an incoming call is received, the user can receive the call ringing at their telephone by going off-hook.



- A single line telephone can only set “Ringling Line Preference”.
- Line access button(s) (Single-CO, Other-CO or Group-CO) should be assigned to CO button(s) beforehand.



- **Required System Programming**  
[408]–[410] Flexible Ringing Assignment — Day/Night/Lunch  
[411]–[413] Delayed Ringing Assignment — Day/Night/Lunch
- **Related Feature Reference**  
Line Access Buttons
- **Operating Instructions References**  
1.2 Proprietary Telephone Settings, “Customizing Your Telephone Functions”, Preferred Line Assignment — Incoming  
1.2 Proprietary Telephone Settings, “Customizing the Buttons on Your Telephone”, Line Access Buttons

### ***Preferred Line Assignment — Outgoing***

A proprietary telephone user can select a desired outgoing line preference to make outside calls from the following 3 line preferences. System Programming and Proprietary Telephone Settings are required.

- Idle Line Preference:** When the user goes off-hook, they are connected to an idle line. An idle line is automatically selected from the pre-assigned lines in program [419].
- Prime Line Preference:** When the user goes off-hook, they are connected to the pre-assigned line. Assign one prime line beforehand.
- No Line Preference:** No line is selected when the user goes off-hook. They must select a line to make a call.



- Line access button(s) (Single-CO, Other-CO or Group-CO) should be assigned to the CO button(s) beforehand.



- **Required System Programming**

- [400] Outside (CO) Line Connection Assignment
- [405]–[407] Flexible Outward Dialing Assignment — Day/Night/Lunch
- [419] Automatic Designated Outside (CO) Line Access

- **Related Feature Reference**

Line Access Buttons

- **Operating Instructions References**

- 1.2 Proprietary Telephone Settings, “Customizing Your Telephone Functions”, Preferred Line Assignment — Outgoing
- 1.2 Proprietary Telephone Settings, “Customizing the Buttons on Your Telephone”, Line Access Buttons

### ***Proprietary Telephone Setting Data Default Set***

Allows a proprietary telephone user to reset the following Proprietary Telephone Settings to the default settings.

- Preferred Line Assignment — Outgoing
- Preferred Line Assignment — Incoming
- Outside (CO) Line Ringing Selection
- Intercom Alert Assignment
- Call Waiting Tone Selection



- **Operating Instructions Reference**

- 1.2 Proprietary Telephone Settings, “Customizing Your Telephone Functions”, Proprietary Telephone Setting Data Default Set

## *Pulse to Tone Conversion*

Allows an extension user to change the dialing mode from Pulse to Tone after entering a telephone number to access services, such as computer telephone services or Voice Mail, which require tones.



- This feature only works for outside (CO) lines which have set “Pulse Mode” or “Call Blocking Mode” in program [401].
- Changing from Tone to Pulse is not possible.



- **Required System Programming**  
[401] Dial Mode
- **Operating Instructions Reference**  
1.7 Useful Features, “Pulse to Tone Conversion”

## *Receiving Calls*

Allows an extension user to receive an intercom or outside call by going off-hook. A proprietary telephone user can also receive a call by pressing the rapid flashing CO or INTERCOM button, and talk (handsfree mode) if the telephone has the SP-PHONE button.



- A proprietary telephone user can select the Line Preference for incoming outside calls. See “Preferred Line Assignment — Incoming” in this section.



- **Required System Programming**  
[408]–[410] “Flexible Ringing Assignment — Day/Night/Lunch”  
[411]–[413] “Delayed Ringing Assignment — Day/Night/Lunch”
- **Related Feature Reference**  
Preferred Line Assignment — Incoming
- **Operating Instructions Reference**  
1.4 Receiving Calls, “Receiving Calls”

## *Redial*

### <Automatic Redial>

Allows a proprietary telephone user to redial the last number dialed, and saved number by the Saved Number Redial feature automatically. This is done by pressing the SP-PHONE or MONITOR button and the corresponding button. Redial will be repeated automatically the assigned number of times in program [113] until the called party answers. The interval time between Automatic Redial is programmed in [114]. If another operation is performed during Automatic Redial, this function will be canceled. This feature is not available for the KX-T7055.

### <Last Number Redial>

Every extension automatically saves the last telephone number dialed so that the extension user can make a call to the same party later using a simple operation.

**<Saved Number Redial>**

Allows a proprietary telephone user to save the current external telephone number in the SAVE button during a conversation, so that the extension user can redial the same party later using a simple operation. The saved number can be redialed until another number is stored. A flexible button can be assigned as the SAVE button in the Proprietary Telephone Settings.



- **Required System Programming**

- [113] Automatic Redial Repeat
- [114] Automatic Redial Interval Time

- **Operating Instructions References**

- 1.2 Proprietary Telephone Settings, “Customizing the Buttons on Your Telephone”, SAVE button
- 1.3 Making Calls, “Redialing Automatically (Automatic Redial)”
- 1.3 Making Calls, “Redialing the Last Number Dialed (Last Number Redial)”
- 1.3 Making Calls, “Redialing the Saved Number (Saved Number Redial)”

## Ringing Pattern Selection

A ringing pattern can be selected depending on the type of call such as an outside call, intercom call and doorphone call. Ringing pattern is as follows,

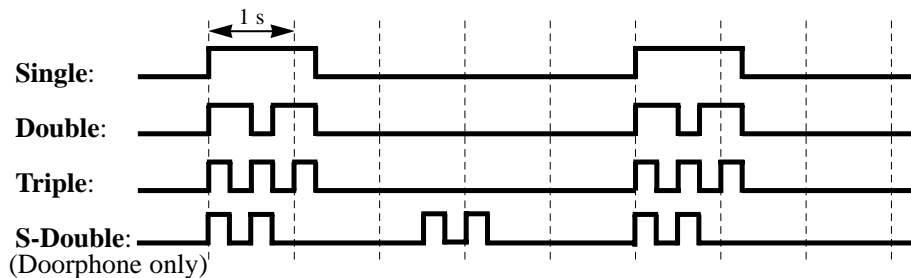

- We recommend considering a combination of ringing patterns for outside calls, intercom calls and doorphone calls. For example, private calls and business calls can be distinguished.



- **Required System Programming**

- [115] Extension Ringing Pattern Selection
- [423] Outside (CO) Line Ringing Pattern Selection
- [706] Doorphone Ringing/Tone Pattern Selection

- **Related Feature Reference**

- Outside (CO) Line Ringing Selection

## Room Monitor

Allows a proprietary telephone user to monitor a room or the front door through another proprietary telephone or doorphone without them knowing. The access tone will not be sent to the monitored proprietary telephone and doorphone when monitoring starts.



- The extensions that can be monitored must be programmed in [612] before operation when using a proprietary telephone.
- If a doorphone is used as a room monitor, the access tone will be heard when monitoring starts as the default setting. The tone can be disabled in program [707].
- This feature is not available for KX-T7050, KX-T7055 and KX-T7350.
- A single line telephone with a MUTE button can be used for monitoring.



- **Required System Programming**
  - [612] Room Monitor Assignment
  - [707] Doorphone Access Tone Selection
- **Related Feature Reference**
  - Doorphone Call
- **Operating Instructions Reference**
  - 1.7 Useful Features, “Room Monitor”

## Secret Dialing

Allows a proprietary telephone user to conceal all or part(s) of a System Speed Dialing number assigned in program [001] or One-Touch Dialing number assigned to a flexible button in the Proprietary Telephone Settings which normally appear on the display.



- When storing a number, press the INTERCOM button at the beginning and the end of the numbers to be concealed.
- One or more parts of a telephone number can be concealed.
- Printing out the concealed number on a SMDR can be assigned in program [803].



- **Required System Programming**
  - [001] System Speed Dialing Entry
  - [803] Secret Speed Dialing/One-Touch Dialing Printing
- **Related Feature References**
  - One-Touch Dialing, System Speed Dialing
- **Operating Instructions References**
  - 1.2 Proprietary Telephone Settings, “Customizing the Buttons on Your Telephone”, One-Touch Dialing Button
  - 1.7 Useful Features, “Secret Dialing”

### ***Self-Extension Number Confirmation*** ***(KX-T7330/KX-T7030/KX-T7130/KX-T7033 only)***

Allows a display proprietary telephone user to confirm their jack and extension number using a simple operation.



- **Operating Instructions Reference**  
1.7 Useful Features, “Self-Extension Number Confirmation (KX-T7330/KX-T7030/KX-T7130/KX-T7033 only)”

### ***Station Feature Clear***

Allows an extension user to reset the following station features to the default settings.

- Absent Message Capability
- Automatic Callback Busy (Camp-On)
- Background Music (BGM)
- Call Forwarding
- Call Pickup Deny
- Call Waiting
- Data Line Security
- Do Not Disturb (DND)
- Executive Busy Override Deny
- Log-In/Log-Out
- Message Waiting – (All messages will be erased.)
- Pickup Dialing – (The stored telephone number will be erased.)
- Paging Deny
- Room Monitor
- Timed Reminder
- Voice Mail Integration



- **Operating Instructions Reference**  
1.7 Useful Features, “Canceling the Feature Settings (Station Feature Clear)”

## Station Hunting

If a called extension is busy, Station Hunting redirects the incoming call to an idle extension in an extension group in numerical order. Idle extensions are automatically hunted according to programming. The following 2 hunting types are available.

**Circular hunting:** The extensions are hunted one time in numerical order. If all extensions are busy, a busy tone will be heard.

**Termination hunting:** The extensions are hunted until the extension which has the highest jack number in the group is reached. If all higher order numbers are busy, the search will end and a busy tone will be heard.



- One hunting type can be selected for each extension group.
- To leave the hunting group temporarily, use the Log-Out feature. To rejoin, use the Log-In feature.
- If the called extension has set Do Not Disturb (DND), Call Forwarding or Log-Out, Station Hunting will skip the extension. However, Station Hunting will not skip the extension which receives the call first, even if it has set Do Not Disturb (DND) or Call Forwarding.



- **Required System Programming**
  - [100] Hunting Group Set
  - [101] Hunting Type
  - [600] Extension Group Assignment
- **Related Feature References**
  - Call Forwarding
  - Do Not Disturb (DND)
  - Extension Group
  - Log-In/Log-Out

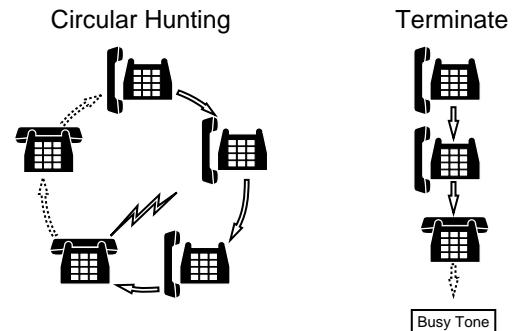

## Station Lock

### <Electronic Station Lockout>

Allows an extension user to lock their station so that other users cannot make outside calls until it is unlocked. Any 4-digit code can be used to lock and unlock an extension.

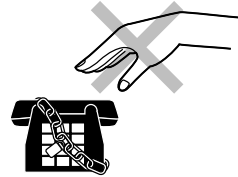

### <Electronic Station Lockout – CANCEL ALL>

The operator and manager can cancel Electronic Station Lockout of all extensions at one time.

### <Remote Station Lock Control>

The operator and manager are given the privilege of controlling Electronic Station Lockout at any station by using the DSS console. The operator and manager can see the status of each extension, locked or unlocked, by the pre-assigned DSS button LED on the DSS console. For example, this feature is useful for a small hotel or motel when guests are checked out.



- The Remote Station Lock Control overrides the Electronic Station Lockout. If the operator or manager sets Remote Station Lock on an extension that has already been locked by the extension user, the user cannot unlock it.
- A toll restriction class can be assigned to an extension which has set the Electronic Station Lockout and Remote Station Lock Control features in program [312] “Toll Restriction – Station Lock Boundary Class”. Certain types of outgoing outside calls are allowed depending on the assigned toll restriction class.



### • Operating Instructions References

- 1.6 Before Leaving Your Desk, “Locking Your Telephone (Electronic Station Lockout)”
- 1.8 Operator / Manager Service Features, “Electronic Station Lockout – CANCEL ALL”
- 1.8 Operator / Manager Service Features, “Remote Station Lock”
- 1.9 DSS Console Features “Initial Setting”, Station Lock Button Assignment (Operator/Manager only)

### Station Message Detail Recording (SMDR)

Station Message Detail Recording (SMDR) automatically prints out detailed call information of outside calls. A printer connected to the Serial Interface (RS-232C) port can be used to print incoming and outgoing outside calls, as well as print a hard copy of System Programming. To print out the record of System Programming items that have been assigned, use program [804] "System Data Dump". To print the call records, use program [802] "Incoming/ Outgoing Call Selection for Printing", which prints out the following records.

- A record of all outgoing outside calls or outgoing toll calls
- A record of all incoming outside calls

*An example of a printed call record:*

| Date     | Time     | Ext  | CO  | Dial Number                      | Duration | Code   |
|----------|----------|------|-----|----------------------------------|----------|--------|
| 12/31/98 | 12:52PM  | 103  | 05  | 12345678901234567890123456789012 | 00:00'16 | ....   |
| 12/31/98 | 12:53PM  | 103  | 02  | < incoming >                     | 00:01'43 | ....   |
| 12/31/98 | *12:54PM | 101  | 02  | < incoming >                     | 00:07'48 | ....   |
| 12/31/98 | 1:04PM   | 103  | 06  | 092...1438                       | 00:00'06 | ....   |
| 12/31/98 | 1:04PM   | 102  | 05  | < DISA incoming >2013570846      | 00:00'09 | 4536 0 |
| 12/31/98 | 1:05PM   | 103  | 01  | < DISA incoming >                | 00:00'08 | .... 0 |
| 12/31/98 | 1:06PM   | 103  | 01  | 092123456789                     | 00:00'08 | ....   |
| 12/31/98 | 1:06PM   | C-05 | 02  | 0921234567                       | 00:00'17 | .... 2 |
| 12/31/98 | 1:07PM   | 103  | 01  | 0921234567                       | 00:11'00 | ..13   |
| 12/31/98 | 2:15PM   | 103  | 01  | 0921234567                       | 00:11'00 | .101   |
| 12/31/98 | 2:26PM   | 103  | 01  | F/0927654321                     | 00:03'00 | ....   |
| 12/31/98 | 2:27PM   | 116  | 05  | 9=0924567123                     | 00:13'55 | ....   |
| 12/31/98 | 3:25PM   | .    | 02  | < UCD Waiting >                  | 00:11'48 | ....   |
| .        | .        | .    | .   | .                                | .        | .      |
| (1)      | (2)      | (3)  | (4) | (5)                              | (6)      | (7)    |

#### Example of the SMDR printout format:

##### Explanation

- (1) Date : shows the date of the call as Month/Day/Year.
- (2) Time : shows the time the call was started as Hour: Minute/AM or PM.  
"\*" indicates a transferred call.
- (3) Ext : shows the extension number, etc. that engaged in the call. "C-xx" indicates an outside-to-outside (CO-to-CO) call via the DISA feature. The outside (CO) line which receives a DISA call is shown as xx.
- (4) CO : shows the outside (CO) line number used for the call.
- (5) Dial Number

**Outgoing call:** Shows the called party's telephone number (maximum 32 digits). Valid digits are 0 through 9, #, \* and P (if the PAUSE button is pressed).

**Received call:** Shows <incoming>. An incoming call via the DISA feature is shown as <DISA incoming>, via the DIL feature is shown as <DIL incoming>.

**UCD waiting call:** Shows <UCD waiting> for an incoming call via the UCD feature. When the “UCD waiting call” is answered, it becomes a “Received call” and a new record is started.

- (6) Duration : shows the duration of the call or the UCD call waiting time in Hours/Minutes/Seconds.
- (7) Code: shows the account code appended to the call, account code index number (e.g.: 13), the extension number which uses the Toll Restriction Override by Extension Password feature (e.g.: 101) or DISA security code status (e.g.: 0). Code “0” indicates a DISA incoming call without a DISA security code. Codes “1 to 4” indicate a DISA incoming call with DISA security code 01 to 04 respectively. For example, code 1 corresponds to DISA security code 01, etc.



- This system can store information of up to 64 calls.
- This data is not deleted even when the system is reset.
- If FLASH is manually sent out during a conversation to make another call without hanging up, etc., a call record will be printed and a new record started. “F/” will be printed at the beginning of the dial number on the new record.
- When a host PBX code is entered, “=” will be printed between the code and dialed number.



- **Connection Reference**
  - 2.13 Printer and PC Connection
- **Required System Programming**
  - [000] Date and Time Setting
  - [204] Call Duration Count Start Time
  - [800] SMDR RS-232C Communication Parameter
  - [801] SMDR Parameter
  - [802] Incoming/Outgoing Call Selection for Printing
  - [803] Secret Speed Dialing/One-Touch Dialing Printing
  - [804] System Data Dump
  - [805] SMDR Account Code Selection
- **Related Feature Reference**
  - Language Selection

### *System Data Default Set*

This system can re-initialize the system-programmed data. If all the programmed data is cleared, the system will reset using the default settings by program [999].



- The default setting for each programming item is listed in Section 5.1, Default Values.



- **Required System Programming**
  - [999] System Data Clear
- **Installation Reference**
  - 2.24 System Data Clear

## System Speed Dialing

The system supports 100 System Speed Dial numbers (up to 32 digits) assigned in program [001] that are available to all extension users. A System Speed Dial number is dialed out using a simple operation.



- Toll Restriction for System Speed Dialing can be assigned by program [301].
- A rotary telephone user cannot use this feature.



- **Required System Programming**
  - [001] System Speed Dialing Entry
  - [301] Toll Restriction – System Speed Dialing Boundary Class
- **Related Feature**
  - Toll Restriction for System Speed Dialing
- **Operating Instructions Reference**
  - 1.3 Making Calls, “Dialing with System Speed Dialing (System Speed Dialing)”

## Timed Reminder

### <Timed Reminder>

Allows an extension user to generate an alarm tone at a preset time as a wake-up alarm or a reminder. The user can set this to be activated once or everyday.

### <Timed Reminder, Remote (Wake-Up Call)>

The operator or manager can remotely set, cancel and confirm the Timed Reminder of the desired extension. For example, this is useful for a small hotel or motel to set an extension in a guest room as a wake-up call, or set an extension in a child’s room by a mother.



- **Operating Instructions References**
  - 1.7 Useful Features, “Alarm Setting (Timed Reminder)”
  - 1.8 Operator / Manager Service Features, “Timed Reminder, Remote (Wake-Up Call)”

### *Time (Day/Night/Lunch) Service*

The system supports the day, night and lunch operation modes. The system operation for making and receiving calls can be different for the day, night and lunch modes. The system operation for toll restriction can be arranged to prevent unauthorized toll calls for each mode. Time service can be set automatically or manually by program [006].

#### **Changing the Day/Night/Lunch Mode**

The day, night and lunch modes can be changed either automatically at an assigned time in program [007] or manually by the operator or manager at any desired time.



- The lunch mode interrupts the day or night mode. After the lunch mode is finished, the day or night mode starts again.
- If the lunch mode is set using feature number “783#” in the automatic mode, the mode can only be canceled by using feature number “780#”. This can be useful during holidays. The day and night modes are automatically changed at the programmed time in [007] even if feature number “780#” is not entered. These operations can only be done by an operator or manager.
- The operator and manager can see the status of the mode (day, night or lunch) by the pre-assigned DSS buttons’ LED on the DSS console. Time service can be changed easily by pressing the pre-assigned DSS buttons.
- The following programming items will be affected by the time service.
  - [405]-[407] Flexible Outward Dialing Assignment
  - [408]-[410] Flexible Ringing Assignment
  - [411]-[413] Delayed Ringing Assignment
  - [414]-[416] Outside (CO) Line Mode
  - [601]-[603] TRS – Class of Service Assignment
  - [700]-[702] Doorphone Ringing Assignment
  - [703]-[705] Door Opener Assignment

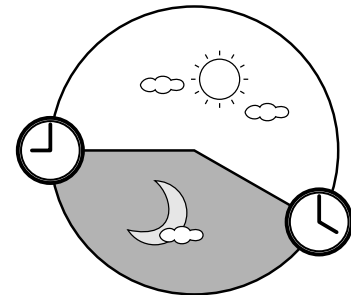

- **Required System Programming**

- [006] Time (Day/Night/Lunch) Service – Changing Mode
- [007] Time (Day/Night/Lunch) Service – Start Time

- **Operating Instructions References**

- 1.8 Operator / Manager Service Features, “Time (Day/Night/Lunch) Service Setting”
- 1.9 DSS Console Features, “Initial Settings”, Day, Night and Lunch Buttons Assignment

## ***Toll Restriction***

Toll Restriction is a system programmable feature that can prohibit certain extension users from making unauthorized toll calls.

Every extension is programmed to belong to one of 5 classes of service (COS). Each COS is programmed to have a toll restriction class for day mode, night mode and lunch mode. There are 5 toll restriction COS numbers available. Toll restriction COS number 1 is the highest class and the COS number 5 is the lowest. That is, COS number 1 allows all toll calls. COS numbers 2 through 5 are used to restrict calls by combining pre-programmed deny and exception codes shown in the table on the next page.

### **Denied Codes**

An outgoing outside call made by an extension with a toll restriction COS number between 2 and 5 is first checked against the assigned denied codes in program [302]-[305].

If the first digits of the dialed number (not including the line access code) are not found in the class, the call can be made. Each class can store up to 20 denied codes, each consisting of 10 digits.

### **Exception Codes**

These codes are used to override a programmed denied code. A call denied by the denied codes is checked against the selected exception codes assigned in program [306]. If a match is found, the call can be made.

Up to 20 exception codes, each consisting of 10 digits, can be stored. The available number of codes depends on the COS number.



- Emergency numbers, such as the police or fire station, should be stored in program [309] “Emergency Dial Number Set” so that they are excepted from toll restriction.
- If a stored Host PBX access code in program [403] “Host PBX Access Codes” or a stored carrier code in program [300] “Carrier Code Assignment” is found in the dialed number, the subsequent telephone numbers will be checked for toll restriction.
- The interdigit timer assigned in program [208] “Interdigit Time” applies until the toll restriction check is completed. When the timer expires, an outside outgoing call will be disconnected while dialing, if “Enable” was selected in program [211] “No Dial Disconnection”.
- The toll restriction class for a station locked extension can be assigned in program [312] “Toll Restriction – Station Lock Boundary Class” so that even a station locked extension can make a local call, etc.
- It is programmable whether the “\*” or “#” the user dials is to be checked or not on the Toll Restriction code in program [125] “Toll Restriction Check for \* and #”. This is useful to prevent unauthorized calls which could be possible through certain Central Office exchange systems.



- **Required System Programming**

- [301] Toll Restriction – System Speed Dialing Boundary Class
- [302]-[305] Toll Restriction – Classes 2 through 5 Denied Codes
- [306] Toll Restriction – Exception Codes
- [601]-[603] TRS – Class of Service Assignment – Day/Night/Lunch

- **Related Feature References**

- Emergency Call
- Toll Restriction for System Speed Dialing
- Toll Restriction Override by Extension Password
- Toll Restriction – Station Lock Boundary Class

*Combination of denied codes and exception codes*

| COS No. | Denied Calls  | Excepted Calls   |
|---------|---|--|
| 1       | No restriction.   | No restriction.  |
| 2       | 20 denied codes programmed in [302].  | 20 exception codes (code numbers 01-20) programmed in [306]. |
| 3       | 20 denied codes programmed in [302] plus 20 denied codes programmed in [303].   | 15 exception codes (code numbers 01-15) programmed in [306]. |
| 4       | 20 denied codes programmed in [302] plus 20 denied codes programmed in [303] plus 20 denied codes programmed in [304].  | 10 exception codes (code numbers 01-10) programmed in [306]. |
| 5       | 20 denied codes programmed in [302] plus 20 denied codes programmed in [303] plus 20 denied codes programmed in [304] plus 20 denied codes programmed in [305]. | 5 exception codes (code numbers 01-05) programmed in [306].  |

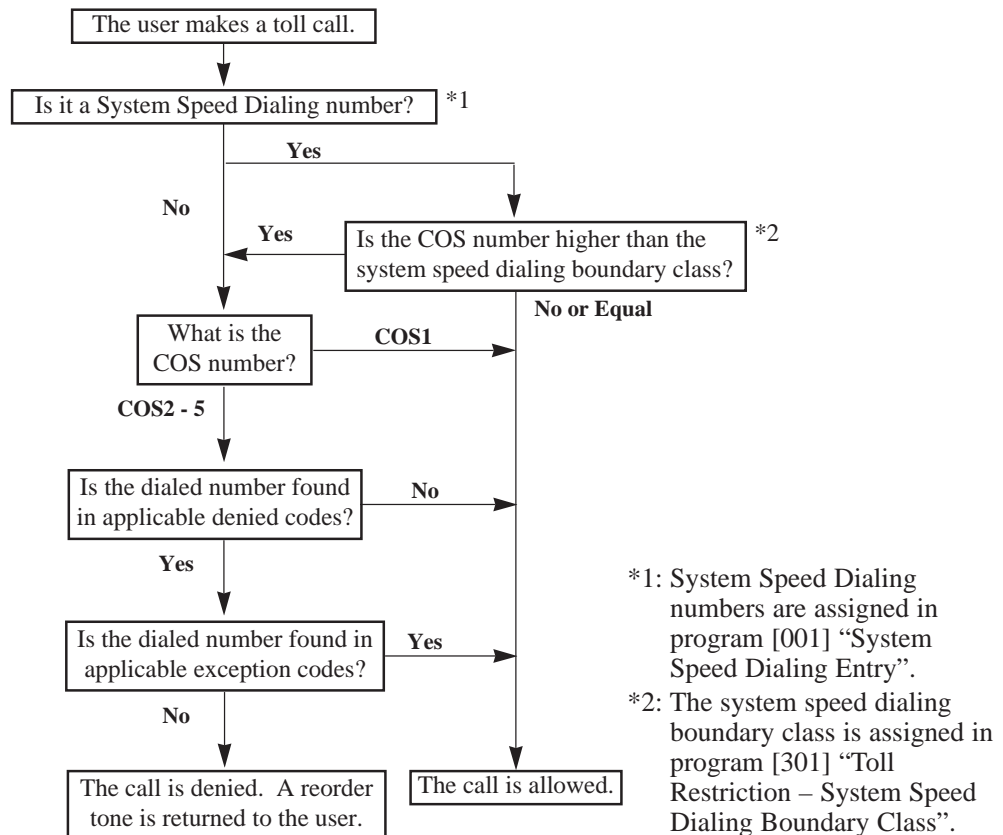
*Flow chart of Toll Restriction*

### *Toll Restriction for System Speed Dialing*

Calls originated by System Speed Dialing are restricted depending on the combination of the System Speed Dialing Boundary Class assigned in program [301] and the class of service (COS) assigned to each extension as follows.

| System Speed Dialing Boundary Class \ COS No. | 1 | 2 | 3 | 4 | 5 |
|---|---|---|---|---|---|
| 1   | A | A | A | A | A |
| 2   | C | A | A | A | A |
| 3   | C | C | A | A | A |
| 4   | C | C | C | A | A |
| 5   | C | C | C | C | A |

<Example>

—If the boundary is set to COS number 2, The system will allow system speed dialing for COS numbers 1 and 2, but check COS numbers 3, 4 and 5 according to toll restriction.

A: allowed      C: checked



- **Required System Programming**  
[301] Toll Restriction – System Speed Dialing Boundary Class
- **Related Feature Reference**  
Toll Restriction

### ***Toll Restriction Override by Extension Password***

Allows an extension user to override toll restriction temporarily to make a toll call from another toll-restricted extension. The user can carry out this feature by entering their extension password, instead of an account code, before dialing the telephone number. The user can make a toll call with their COS number.



- The account code “Verify–Toll” mode at another extension permits users to override another extension’s toll restrictions.
- If the user does not enter the extension password or enters an invalid password, a regular toll restriction check is done.
- When a user makes a call using this feature, the user’s extension number will be displayed on the SMDR.
- Users can also override toll restriction of another extension by using the Walking COS feature.
- To override toll restriction in the “Option”, “Forced” or “Verify–All” mode, use the Walking COS feature.

#### ***Flow chart of TRS Override***

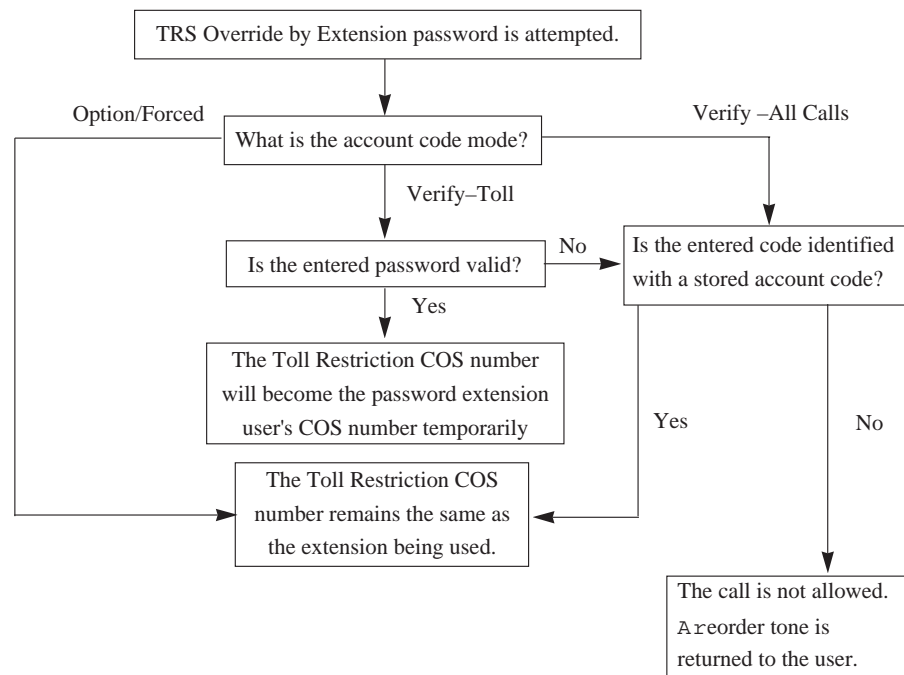

- **Required System Programming**

[605] Account Code Entry Mode

- **Related Feature References**

Account Code Entry, Extension Password/System Password, Station Message Detail Recording (SMDR), Toll Restriction, Walking COS

### ***Toll Restriction — Station Lock Boundary Class***

Allows assigning a toll restriction class for extensions where the Electronic Station Lockout or Remote Station Lock feature has been set.

An extension user usually cannot make an outside call at a locked extension, however if a toll restriction class is assigned in program [312], the user can make an outside call at the locked extension.



- The higher toll restriction class number will take precedence. For example, if toll restriction COS number 3 is assigned to an extension and the station lock boundary class is 4, the extension user is allowed to make a call with toll restriction COS number 4.



- **Required System Program Address**  
[312] Toll Restriction – Station Lock Boundary Class
- **Related Feature References**  
Station Lock, Toll Restriction

### ***Uniform Call Distribution (UCD)***

Distributes incoming calls to one specific extension group called a UCD group assigned in program [520]. Calls to the UCD group hunt for an idle extension in numerical order. The UCD feature is particularly helpful when a certain extension receives a high volume of calls compared with other extensions.



- An optional OGM/FAX Detection Card is required to perform the UCD feature.
- The Log-In or Log-Out status can be set on an extension basis. There should be at least one extension that is in Log -In status in the UCD group.
- An extension which sets the Call Forwarding–All, –Busy or No Answer, or the Do Not Disturb (DND) feature is skipped during circular calling.
- When all extensions in the UCD group are busy, a busy message is heard and then Music on Hold is activated. If any extension in the UCD group is not available within the programmed time period, then (1) an OGM will be heard and the call is disconnected, or (2) the call will be sent to pre-programmed extension(s) in [408]-[410]. System Programming is required for this operation. Refer to the “Flow chart of possible cases and results for UCD calls”.



- **Connection Reference**  
2.15 OGM/FAX Detection Card Installation
- **Required System Programming**  
[111] Hold Music Selection  
[408]-[410] Flexible Ringing Assignment – Day/Night/Lunch  
[414]-[416] Outside (CO) Line Mode — Day/Night/Lunch  
[502] OGM Mode Selection  
[513] Cyclic Tone Detection  
[520] UCD Group

- [521] UCD Busy Waiting Time
- [522] UCD OGM Message Interval Time
- [523] UCD Busy Mode
- [524] UCD Intercept Mode
- [525] UCD Ringing Time before Intercept
- [526] UCD Ringing Time after Intercept
- [600] Extension Group Assignment

• **Related Feature References**

Call Forwarding, Do Not Disturb (DND), Extension Group, Log-In/Log-Out

**Outline of a UCD**

- (1) When a number of calls have arrived at the UCD group, the first call arrives at extension A first.
- (2) When the first call arrives at extension A, the second call arrives at extension B.

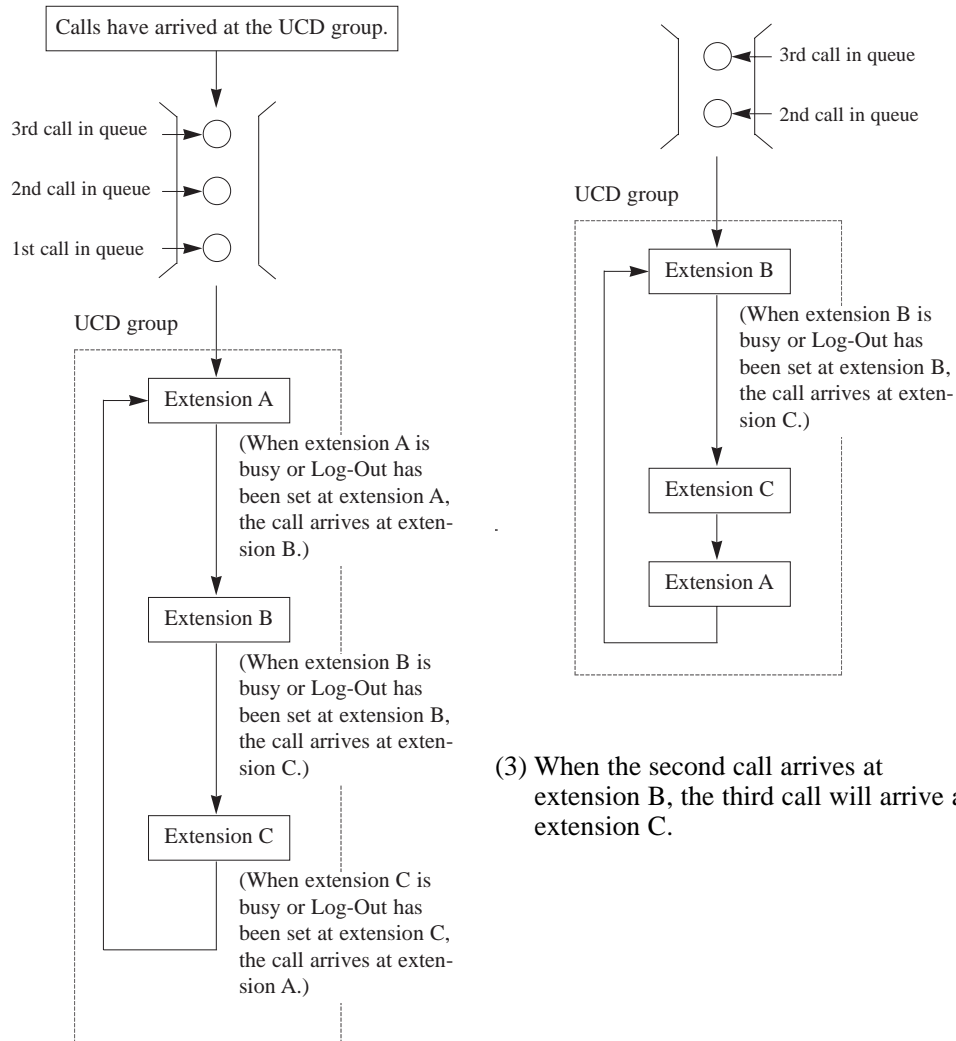

- (3) When the second call arrives at extension B, the third call will arrive at extension C.

*Flow chart of possible cases and results for UCD calls*

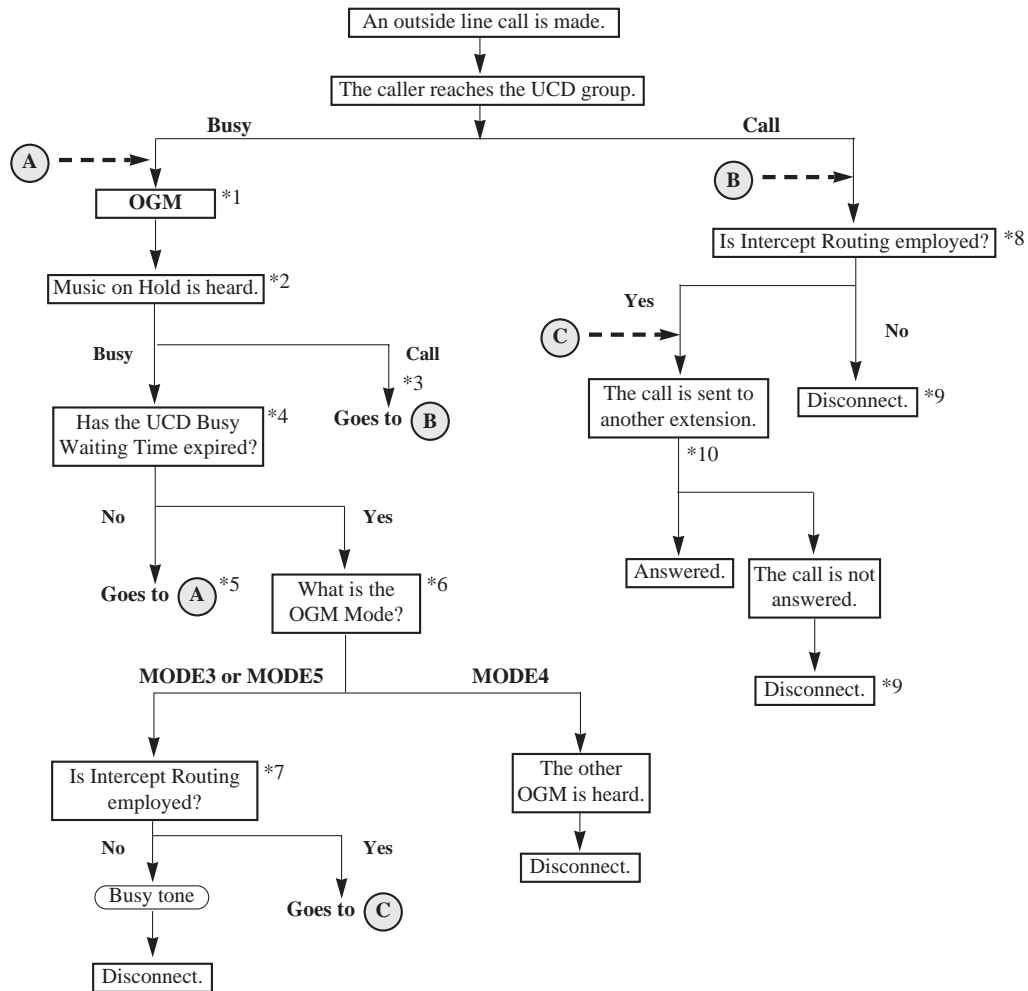

- \*1: An OGM is sent to the caller.  
When the system detects a cyclic tone or CPC signal while the OGM is being sent, the call is disconnected.
- \*2: Music on hold is selected in program [111] as follows.
  - **External** – Uses an external music source, such as radio.
  - **Internal** – Uses the internal music source equipped with the system.
  - **Tone** – Uses the cyclic tone equipped with the system.
- \*3: When an extension in the UCD group is available.
- \*4: The system holds the call until the assigned time in program [521] expires.
- \*5: OGM repeats the assigned time intervals in program [522] within the assigned time in program [521].
- \*6: The other OGM (OGM2) is selected in program [502].
- \*7: The system treats the call according to program [523] as follows when the assigned time in [521] expires.
  - **Disconnect** – the call is disconnected.
  - **Intercept** – the call is sent to the extensions programmed in [408]-[410].
- \*8: The system treats the call according to program [524] as follows when the assigned time in [525] expires.
  - **Disconnect** – the call is disconnected.
  - **Intercept** – the call is sent to the extensions programmed in [408]-[410].
- \*9: If the caller did not hear an OGM, the call will not be disconnected until the caller goes on-hook.
- \*10: The UCD Ring Timer After Intercept starts. The destination telephone(s) will ring for the time programmed in program [526]. If the call is not answered during the programmed time, the call will be disconnected.

## Voice Mail Integration

This system supports Voice Processing System (VPS) equipment by sending DTMF tones described in program [103]. The DTMF tones sent to a VPS indicate the state of a call (busy, answered, ringing, disconnected, etc.). The DTMF tones also inform a VPS of the destination of a call transferred to the VPS by the Call Forwarding or DISA Intercept Routing – No Answer feature. Up to 4 VPSs can be connected to the extension jacks as extensions in the system.

### System Explanation

#### 1. Voice Mail Service

##### 1.1 Call Forwarding to VM

If an extension user sets Call Forwarding (C. FWD) whose destination is the VPS, an incoming call is forwarded to the VPS. The system sends the VPS the extension mailbox number at that time. Therefore, the calling party can leave their message in the mailbox of the desired extension without having to know the mailbox number.

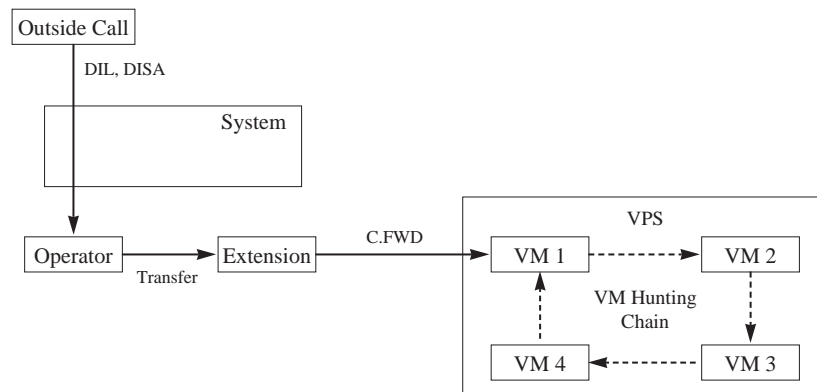
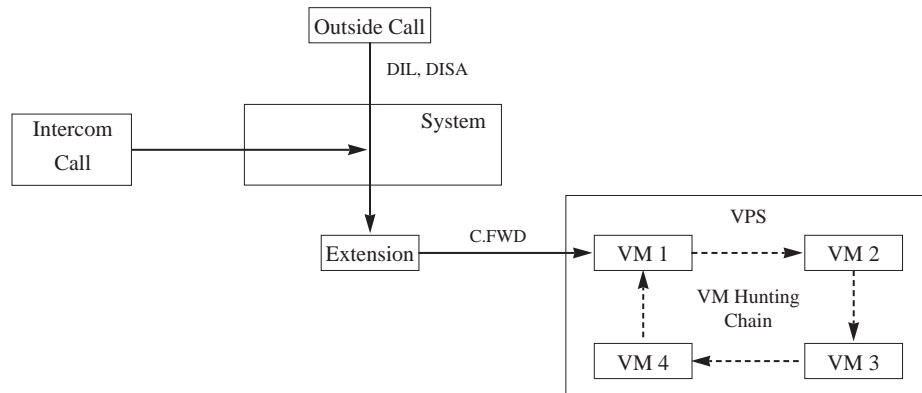

### 1.2 DISA Intercept to VM

If an outside (CO) line is set as the Intercept whose destination is the VPS, an outside call is forwarded to the VPS. The system sends the VPS the extension mailbox number at that time. Therefore, the calling party can leave their message in the mailbox of the desired extension without having to know the mailbox number. If a DISA call is transferred to the VPS by Intercept Routing from a DISA ring group, your system will transmit the mailbox number of the lowest jack number of the DISA ring group. Delayed Ringing must be assigned to VPS extensions in programs [411]-[413].

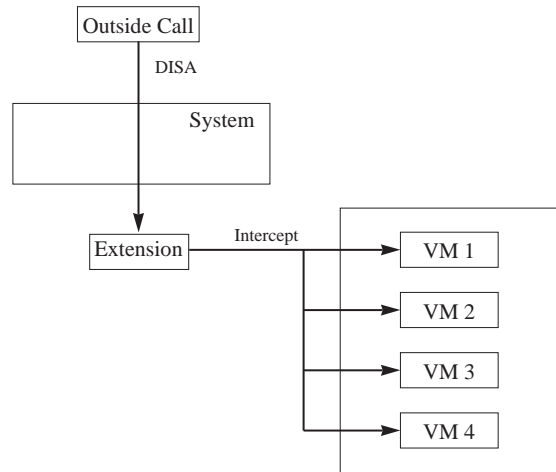

### 1.3 Listening to a Recorded Message

If the VPS receives a message, the VPS can turn on the MESSAGE button indicator on the corresponding proprietary telephone to notify to the user. (Panasonic KX-TVP series can do this.) The VPS notifies the extension user that there is a message waiting in their mailbox. When the MESSAGE button indicator is lit, pressing the button allows the extension user to play back the stored message. A single line telephone user hears dial tone 3 (☞ “Distinctive Dial Tone” in this section) when going off-hook if there are messages in their mailbox. They can call the voice mail extension to listen to their messages. In this case, they must listen to all of the messages. Once they access voice mail, dial tone 3 will be eliminated and not be heard next time they go off-hook. Therefore, they will not know even if there are messages left.

## 2. Automated Attendant (AA) Service

### 2.1 AA to Extension

AA receives and answers outside calls and offers services such as transferring to an extension or mailbox using DTMF signaling, which is sent from the calling party.

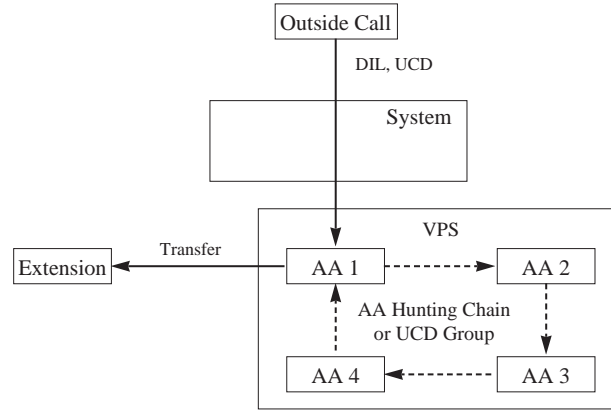

- A VPS can be assigned as the destination for the following features.
  - Call Forwarding – All Calls
  - Call Forwarding – Busy/No Answer
  - DISA Intercept Routing – No Answer

In these functions, the caller does not need to know the mailbox number of the called extension because the code is automatically transmitted to the VPS.

- The mailbox number is the same as its extension number.
- The Voice Mail extension should set Data Line Security to achieve proper recording.
- If your VPS is a Panasonic KX-TVP series and KX-TA308 or KX-TA616 cannot be selected in the PBX type setup menu, select “KX-T1232”. Follow the steps for a KX-T1232.



- **Connection Reference**

- 2.8 Extension Connection

- **Required System Programming**

- [009] Extension Number Assignment
  - [102] Voice Mail Port
  - [103] DTMF Integration
  - [408]-[410] Flexible Ringing Assignment — Day/Night/Lunch
  - [411]-[413] Delayed Ringing Assignment — Day/Night/Lunch
  - [414]-[416] Outside (CO) Line Mode — Day/Night/Lunch
  - [507] DISA Intercept Mode

- **Related Feature References**

- Call Forwarding, Data Line Security, Direct Inward System Access (DISA), Distinctive Dial Tone, Intercept Routing, Station Hunting

- **Operating Instructions Reference**

- 1.7 Useful Features, “Voice Mail Integration”

### ***Volume Control***

Allows a proprietary telephone user to adjust the following volumes, as necessary, by adjusting the corresponding levers or pressing the corresponding buttons.

- Handset receiver volume
- Headset volume
- Ringer volume
- Speaker volume



- **Operating Instructions Reference**

- 1.2 Proprietary Telephone Settings, “Volume Control — Handset Receiver/Headset / Ringer/Speaker”

### ***Walking COS***

Allows an extension user who is not at their own telephone to override the toll restriction COS number of another extension by dialing their extension password. For the duration of the call, the COS of the extension is changed to the COS of their own extension.



- If the extension overriding toll restriction is assigned to “Forced” or “Verify–All”, the user must enter the account code before the line access code.
- When a user makes a call using this feature, the user’s extension number will be displayed on the SMDR, not the extension where the user made the call.



- **Operating Instructions References**

- 1.7 Useful Features, “Calling Using Your Privileges at Another Extension (Walking COS)”

- 1.8 Operator / Manager Service Features, “Extension Password Set (Manager only)”



*Section 4*  
*System Programming*

## 4.1 Before System Programming

---

**NOTE:**

**System data clear should be performed before System Programming.**

(☞ 2.22, Starting the System for the First Time)

### Default Setting

This system has factory default settings (☞ 5.1, Default Values). If any of the programming needs to be changed, you can change the setting by System Programming. **Default** shows you the factory default setting. Any required changes can be written in the Programming Tables listed in section 7, Programming Tables.

### Required Telephone Set

One of the following display proprietary telephones is required for System Programming.

- KX-T7330, KX-T7030, KX-T7130 or KX-T7033

Connect the telephone to the following.

- Jack number 01

### Before entering the programming mode

Before entering the programming mode, confirm that:

- Your telephone is on-hook.
- No calls are on hold at your telephone.

### Placing the Overlay on a Telephone

A programming overlay is packed with the telephone at the factory. This overlay should be used at all times during programming. The functions of the telephone keys change during programming as shown below.

#### Location of Controls with the Overlay

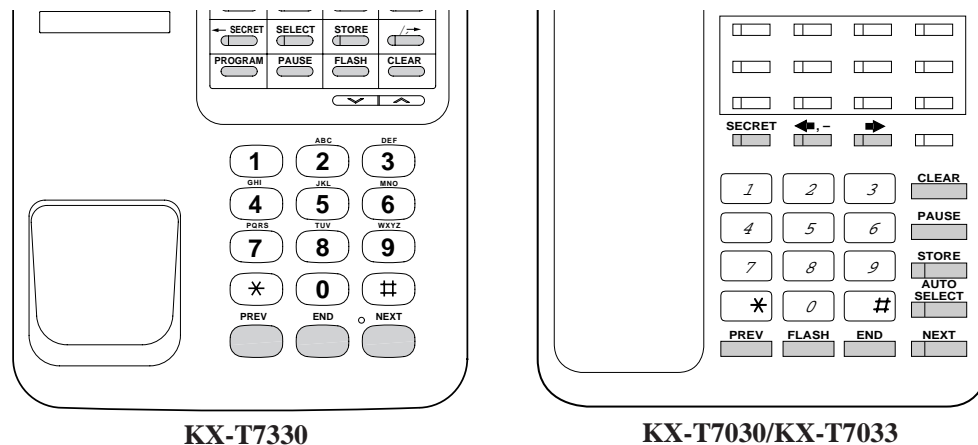

## 4.1 Before System Programming

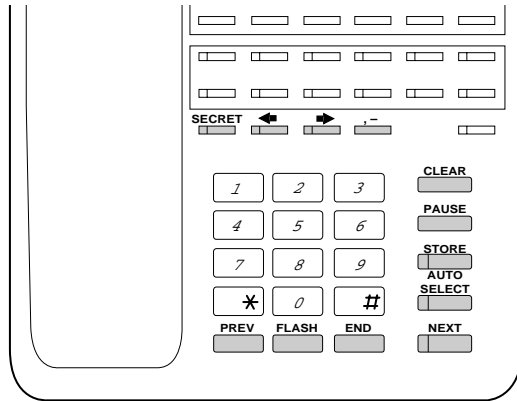

KX-T7130

### To enter the programming mode

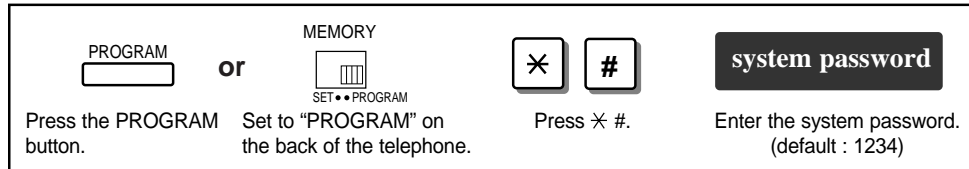

- ! The system password can be changed by program [002] "System Password".
- During the programming mode, your extension is treated as a busy extension.
- If you enter the wrong system password, you will hear an alarm tone (3 beeps). Try again.

### Programming sequence

After entering the programming mode

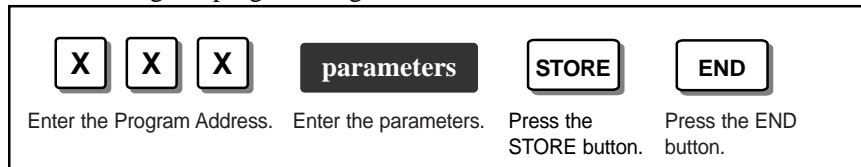

After pressing the STORE button, you will hear one of the following tones.

- Confirmation tone (1 beep):** This informs you that storing is completed. You can continue programming by entering the same or another program address
- (2 beeps):** This informs you that the same parameter has already been stored.
- Alarm tone (3 beeps):** This informs you that the entry is invalid.

### To exit the programming mode

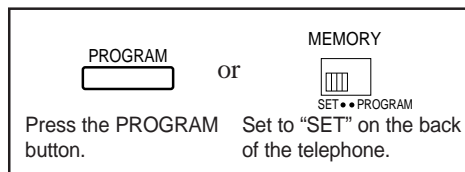

## 4.1 Before System Programming

### Programming example

The following programming instructions assume that you have already entered the programming mode.

Example: Program [404] “Outside (CO) Line Group Assignment”

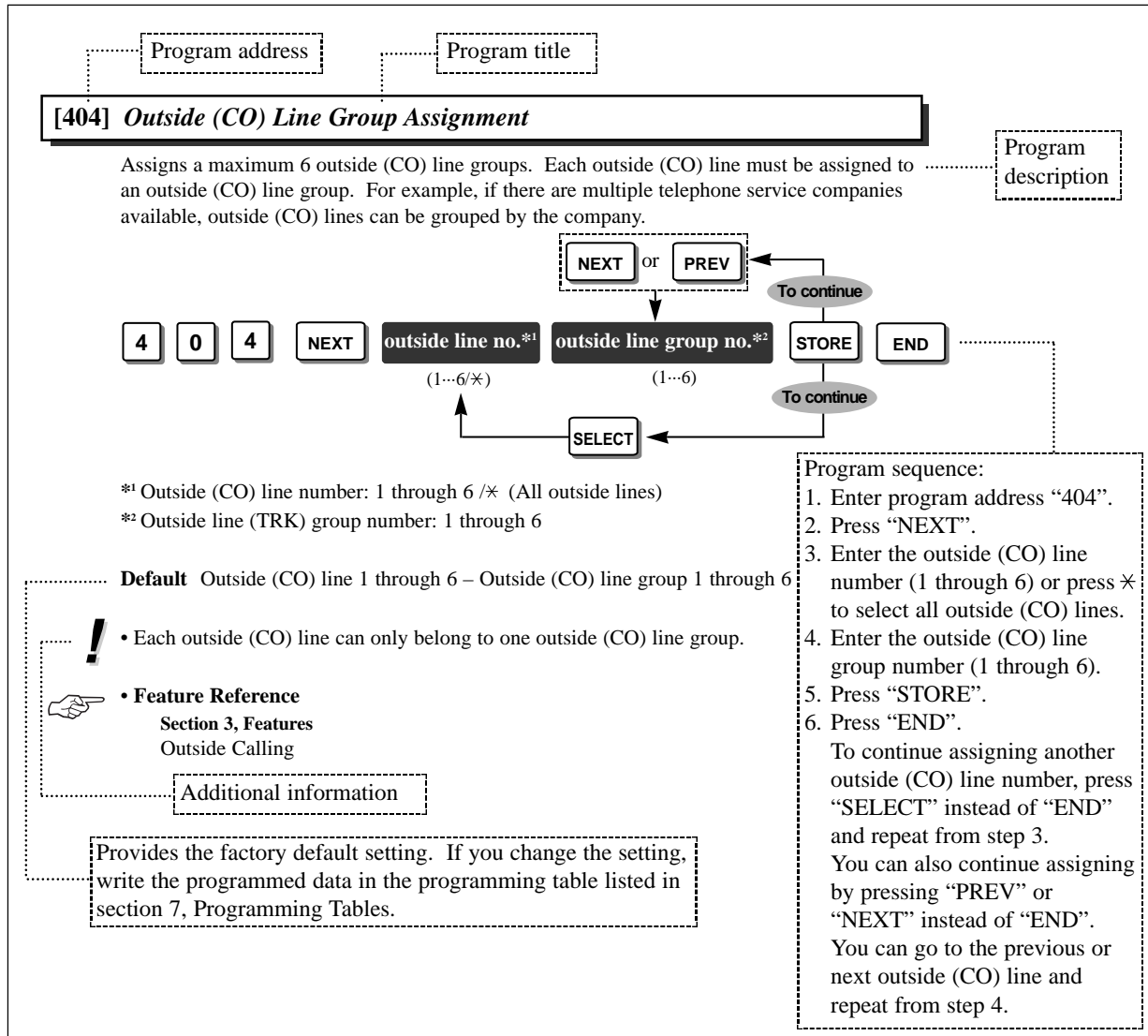

### Additional Information

- When you press \*, for example in step 3 in program [404], if all outside (CO) lines have been assigned as outside (CO) line group 1, “CO \* : TRK GRP – 1” will be displayed. If each outside (CO) line has been assigned to a different outside (CO) line group, “CO \* : Mixed” will be displayed.
- You can press the SELECT button repeatedly to select the desired parameter, if available.
- You can use the or button to move to the next/previous step, if available.

**[000] Date and Time Setting**

Sets the current date and time.

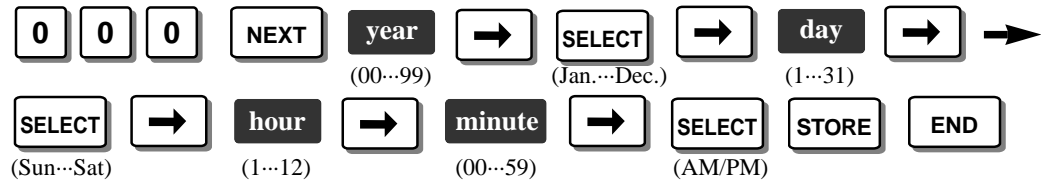

**Default** '98 Jan. 1 Thu 12:00 AM

- ! • To return to the previous programming step, press .
- ! • To correct a wrong entry for the year, day, hour or minute, press the CLEAR button and enter the new one in each step.
- ! • After changing an entry, you can press the STORE button. You do not have to perform the rest of the steps.
- ! • The clock starts immediately after the STORE button is pressed.
- ! • The system supports years from 1998 to 2097.



- **Feature References**  
 Section 3, Features  
 Date and Time Setting, Station Message Detail Recording (SMDR)

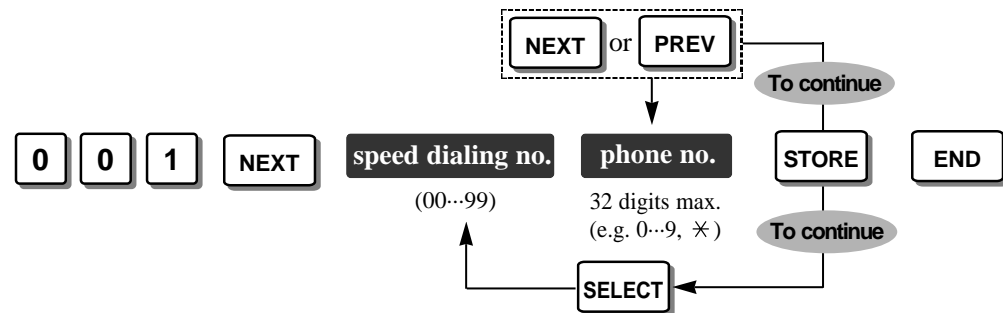

**[001] System Speed Dialing Entry**

Assigns a maximum of 100 System Speed Dialing numbers. To delete a stored phone number, press the CLEAR and STORE buttons after entering the Speed Dialing number.



**Default** Not stored.

- ! • To correct a wrong entry, press the CLEAR button and enter the new one.
- ! • A line access number (9 or 0, 81 through 86) should be included before the phone number.

- Up to 32 digits, consisting of “0 through 9”, “\*”, “#”, “PAUSE”, “—”, “FLASH” and “ICM (Secret)” can be stored.
- If you are storing an account code assigned in [310] “Account Codes”, enter \*\* and the account code after a line access number.
- If you want to conceal all or part of a System Speed Dialing number on the display, enter “[” and “]” (press the ICM button) before and after the part you want to conceal. Do not press the ICM button before and after a line access number (9 or 0, 81 through 86) or an account code. “[” and “]” are counted as one digit.
- Press  or  to scroll the display



- **Feature References**  
Section 3, Features  
Secret Dialing, System Speed Dialing

**[002] System Password**

Assigns the password required for entering the System Programming mode. Also it is used to set an extension password.



**Default** 1234



- To correct a wrong entry, press the CLEAR button and enter the new one.



- **Feature Reference**  
Section 3, Features  
Extension Password / System Password

**[003] DSS Console Port Assignment**

Assigns a maximum of 2 jack numbers to connect the DSS console(s).

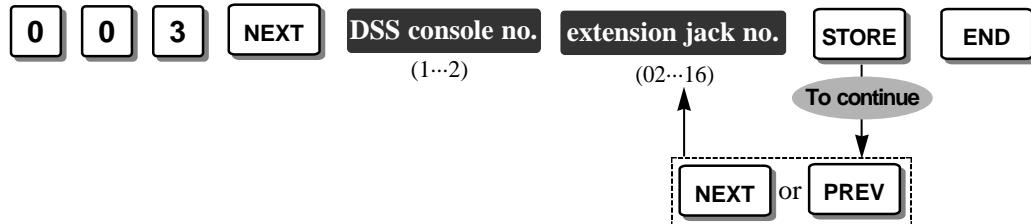

**Default** All DSS consoles – Disable (Not stored)



- Two DSS consoles cannot be assigned to the same jack number.
- Extension jack 01 is the manager extension. So please do not assign extension jack 01 as the DSS console jack.
- To not assign an extension jack number, press the CLEAR button in the extension jack number step.
- The extension jack number which has already been assigned as a paired telephone in program [004] “Paired Telephone Assignment for DSS Console” is not available in this program.



- **Feature Reference**  
Section 3, Features  
DSS Console

**[004] Paired Telephone Assignment for DSS Console**

Assigns a jack number for an extension paired with the DSS console.

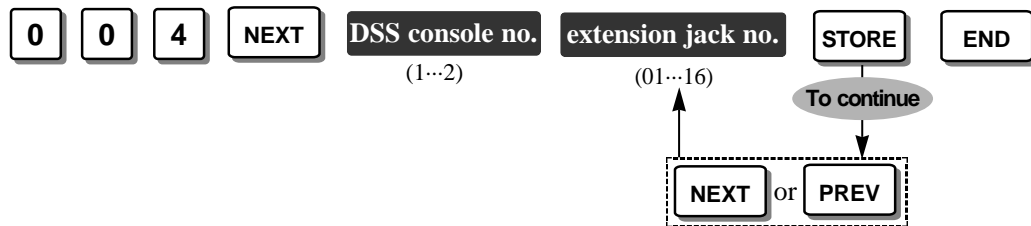

**Default** Extension jack number paired with DSS console 1 – Disable (Not stored)  
Extension jack number paired with DSS console 2 – Disable (Not stored)



- A single line telephone (SLT) cannot be paired with the DSS console.
- To not assign an extension jack number, press the CLEAR button in the extension jack number step.
- The extension jack number which has already been assigned as a DSS console in program [003] “DSS Console Port Assignment” is not available in this program.



- **Feature Reference**  
Section 3, Features  
DSS Console

**[005] *One-Touch Transfer Using a DSS Button***

Selects how an outside call is transferred to any extension using the DSS button.

**With Transfer:** Press the DSS button to transfer an outside call.

**Without Transfer:** Press the TRANSFER button then the DSS button to transfer an outside call.



(With Transfer/  
Without Transfer)

**Default**      With Transfer



- This program is effective for 2 kinds of DSS buttons. One is on the DSS console, and the other is flexible CO button on your proprietary telephone assigned as a DSS button.



- **Operating Instructions References**

- 1.2 Proprietary Telephone Settings, “Customizing the Buttons on Your Telephone”,  
DSS (Direct Station Selection) Button
- 1.9 DSS Console Features, “Initial Settings”, One-Touch Dialing Assignment

**[006] *Time (Day/Night/Lunch) Service Changing Mode***

Selects changing the day, night and lunch service manually or automatically. For manual changing, refer to the Operating Instructions. For automatic changing, set the next program [007] “Time (Day/Night/Lunch) Service Starting Time”.



(Man/Auto)

**Default**      Manual



- **Feature Reference**

- Section 3, Features  
Time (Day/Night/Lunch) Service

**[007] Time (Day/Night/Lunch) Service Start Time**

Sets the starting time on a week day basis, when “Automatic” is selected in program [006] “Time (Day/Night/Lunch) Service Changing Mode”.

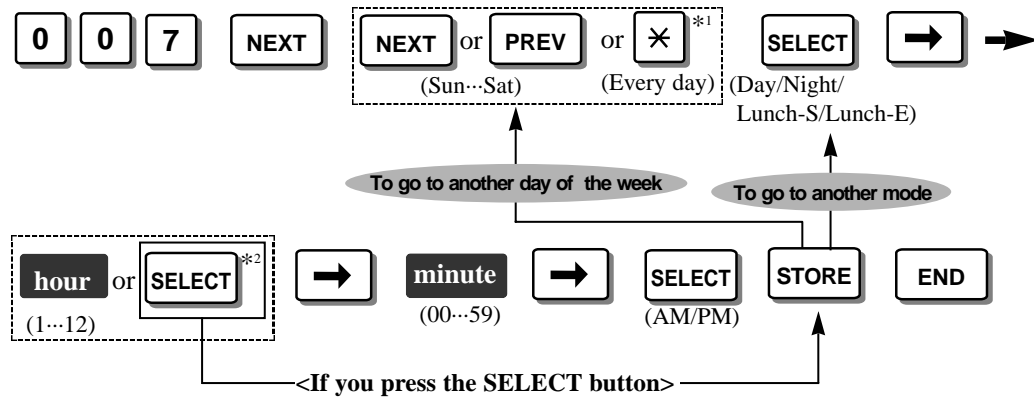

\*1 To assign every day of the week to one selection, press the \* button.

\*2 If the SELECT button is pressed, the display will show the previous entry. If the previous setting was “None”, press the SELECT button to enter the starting time. If you do not need to change the time service, keep pressing the SELECT button until “None” is displayed. For example, if Monday’s day mode is set to “None”, the day mode will not be turned on Monday.

**Default**      Everyday – Day – 9:00 AM / Night – 5:00 PM /  
 Lunch-S (starting) – None / Lunch-E (ending) – None



- **Feature Reference**
- Section 3, Features
- Time (Day/Night/Lunch) Service

**[008] Operator Assignment**

Assigns an extension jack number for the operator.



**Default** Jack-01



- **Feature References**  
Section 3, Features  
Operator / Manager Extension, Operator Call

**[009] Extension Number Assignment**

Assigns an extension number (100 through 199) to each extension.

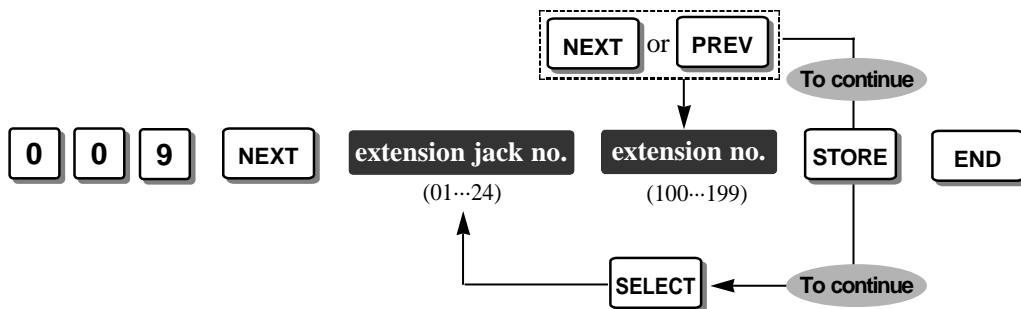

**Default** Extension jacks 01 through 24 – 101 through 124



- A double entry is invalid. If the programmed extension number is the same as a previously stored one, 2 beeps will be heard when the STORE button is pressed. When extension number 103 has already been assigned to jack number 03, to assign extension number 103 to the jack number 05, change the extension number of jack number 03 to another one (100 through 199). Then assign extension number 103 to jack number 05.



- **Feature Reference**  
Section 3, Features  
Intercom Calling

### [010] LCD Time Display Selection

Selects how the current time will be displayed on a proprietary telephone while idle. Either 12 hour or 24 hour (military time) can be selected.

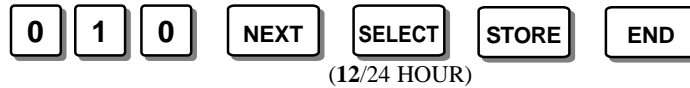

**Display example:**

When “12 HOUR” is selected: Jan 1 11:20PM

When “24 HOUR” is selected: 1 Jan 23:20

**Default** 12 HOUR



- Programs [000] “Date and Time Setting” and [007] “Time (Day/Night/ Lunch) Service Start Time”, and the Timer Reminder feature are assigned using 12-hour time regardless of this program. The SMDR printout is also printed using 12-hour time.

**[100] Hunting Group Set**

Enables or disables automatically locating an idle extension in the same extension group as the dialed extension, when the called extension is busy. If “Enable” is selected, assign the next program [101] “Hunting Type”. The extension group is assigned in program [600] “Extension Group Assignment”.

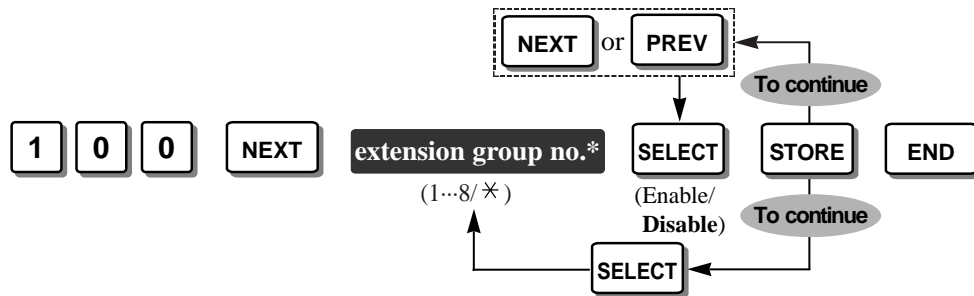

\* Extension group number: 1 through 8 / \* (all extension groups)

**Default** All extension groups – Disable



- **Feature Reference**  
Section 3, Features  
Station Hunting

**[101] Hunting Type**

Assigns the hunting type, **Terminate** or **Circular**, to each extension group when a hunting group is enabled in program [100] “Hunting Group Set”.

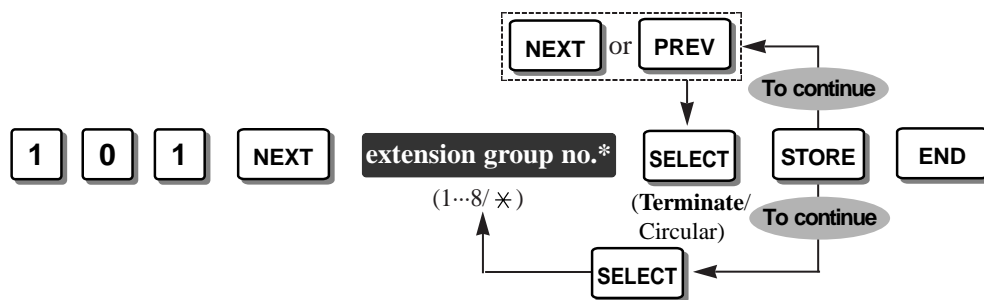

\* Extension group number: 1 through 8 / \* (all extension groups)

**Default** All extension groups – Terminate



- **Feature Reference**  
Section 3, Features  
Station Hunting

**[102] Voice Mail Port**

Assigns the extension jack number(s) connected to a Voice Processing System (VPS). Only extension jacks 07, 08, 15 and 16 are available.

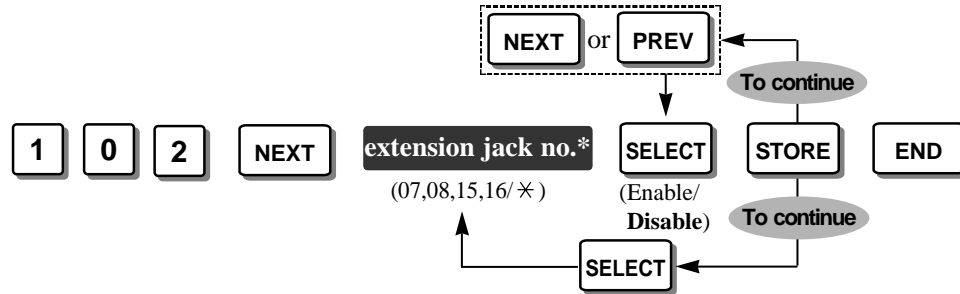

\* Extension jack number: 07, 08, 15 and/or 16 / \*(All 4 extension jacks)

**Default** All extension jacks – Disable



- **Feature Reference**  
Section 3, Features  
Voice Mail Integration

**[103] DTMF Integration**

Enables or disables the system to send codes (DTMF signals) to the extension(s) assigned as the Voice Mail Port in program [102] “Voice Mail Port”. These DTMF signals indicate the state of the call (busy, answered, ringing, disconnected, etc.) in addition to the normal call tones. They also enable the Voice Processing System (VPS) to immediately recognize the current state of the call and speed up the call handling.

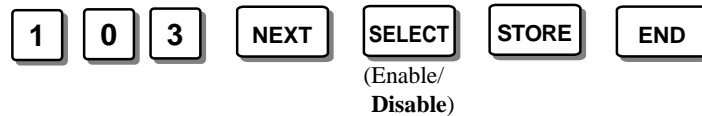

**Default** Disable



- The table on next page describes the codes (DTMF signals), call state and conditions for the DTMF integration operation.
- This feature greatly improves the performance of the Panasonic KX-TVP series: Voice Processing Systems which have been programmed for Inband Signaling. For more information about Inband Signaling, refer to your Voice Processing System manual.



- **Feature Reference**  
Section 3, Features  
Voice Mail Integration

*DTMF signals*

| Code | Call State                                     | Conditions   |
|------|--|--|
| 1    | Ringback Tone                                  | When an extension a VPS has dialed is ringing.   |
| 2    | Busy Tone                                      | When an extension a VPS has dialed is busy.  |
| 3    | Reorder Tone                                   | When a VPS dials an invalid extension number or when a VPS is accidentally connected to another Voice Mail Port.   |
| 4    | DND  | When an extension a VPS has dialed sets the DND (Do Not Disturb) feature.  |
| 5    | Answer   | When an extension which a VPS has dialed answers the call.   |
| 6    | Forwarded to Voice Processing System (Ringing) | When a called extension is forwarded to a VPS, the call can be forwarded to another available VPS. In this way, the first VPS, typically an Auto-Attendant, can release the call to another VPS and receive another incoming call. |
| 7    | Forwarded to Voice Mail (Busy)                 | When a called extension is forwarded to a VPS and no VPSs are available to receive the call.   |
| 8    | Forwarded to Extension                         | When a called extension is forwarded to another, non-VPS extension.  |
| 9    | Confirmation Tone                              | When a VPS has successfully turned a message waiting lamp on or a message waiting lamp off.  |
| #9   | Disconnect                                     | When the calling party disconnects.  |

**[104] Hold Mode Selection**

You can select how to hold a line and transfer a call to another extension with a single line telephone (SLT), **Hold-1**, **Hold-2** or **Hold-3**. If the following occurs frequently with an SLT, select “Hold-2” or “Hold-3”.

- Nobody answers when a call is received.
- A busy tone is heard even though nobody is using the outside (CO) line.

If a call is not terminated after going on-hook, the above cases occur. To avoid these problems, select “Hold-2” or “Hold-3”. Every call will be terminated unless 20 is dialed after flashing the hookswitch in the Hold-2 and Hold-3 modes.

**Hold-1:** To hold a line or transfer a call, flash the hookswitch.

**Hold-2:** To hold a line, flash the hookswitch and dial 20. To transfer a call, flash the hookswitch.

**Hold-3:** To hold a line or transfer a call, flash the hookswitch and dial 20.



(Hold-1/Hold-2  
Hold-3)

**Default** Hold-1



- **Feature Reference**  
Section 3, Features  
Hold

**[105] Conference Tone**

Enables or disables the confirmation tone before starting or ending a conference call established by the Conference feature or Executive Busy Override feature.



(Enable/  
Disable)

**Default** Enable



- **Feature References**  
Section 3, Features  
Conference (3-party), Conference (5-party), Executive Busy Override

**[106] External Paging Access Tone**

Enables or disables the confirmation tone before paging is sent over the external pager.

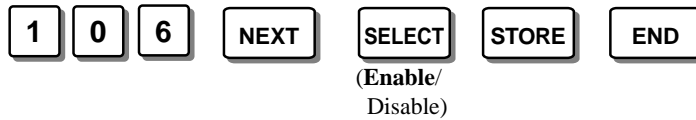

**Default** Enable



- **Feature Reference**  
Section 3, Features  
Paging

**[107] DTMF Receiver Check**

Enables or disables the 6 DTMF receivers to check whether the DTMF receivers are activated normally or not. Refer to the Section 6 Troubleshooting, “While Operating” for further information on checking the DTMF receivers.

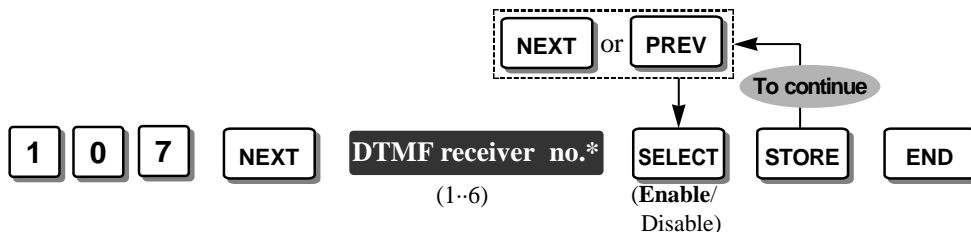

- \* DTMF receiver number: 1 and 2 (for checking extension jacks 01 through 08)/  
3 and 4 (for checking extension jacks 09 through 16)/  
5 and 6 (for checking extension jacks 17 through 24)

**Default** All DTMF receivers – Enable

**[108] Flash Mode for a Station Locked Extension**

Enables or disables a station locked extension to send a flash signal during a conversation with an external party.



**Default** Disable

**[109] CO Indicator Assignment**

Enables or disables an extension which was assigned not to ring in programs [408]-[410] “Flexible Ringing Assignment” to answer an incoming outside call. The CO button indicator will flash when an outside call is received. If enabled, an extension user can answer the call by pressing the flashing CO button. If disabled, the user cannot answer the call even if they press the CO button.

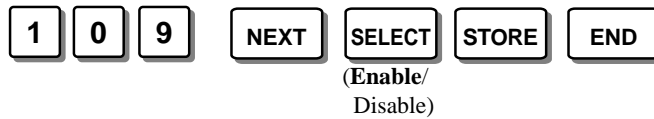

**Default** Enable

-  • The extension must be a proprietary telephone with a CO button and indicator.

**[110] Flash Key Mode**

Assigns the sending the flash signal mode, **MODE 1** or **MODE 2**, when the FLASH button on a proprietary telephone is pressed.

**MODE 1:** The flash signal is sent during the programmed time in [418] “Flash Time”.

**MODE 2:** The flash signal is sent while the FLASH button is pressed if the time the FLASH button was pressed is more than the programmed time in [418]. This will be useful to disconnect the current call and make another call without hanging up. If the time the FLASH button was pressed is less than the programmed time in [418], the flash signal will be sent during the programmed time.

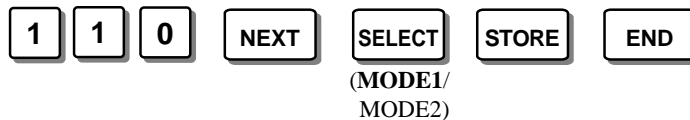

**Default** MODE 1

-  • **Feature Reference**  
Section 3, Features  
Flash

**[111] Hold Music Selection**

Selects the music source, Internal, External or Tone, which an external party will hear when an outside call is on hold.

**External** : Uses an external music source, such as a radio.

**Internal** : Uses the internal music source equipped with the system.

**Tone** : Uses the cyclic tone below equipped with the system.

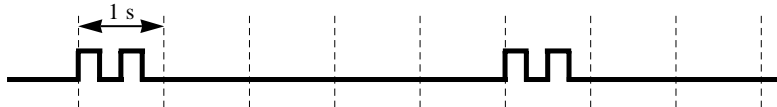

**Default** Internal



- The music source can also be used for BGM.



- **Feature Reference**  
Section 3, Features  
Music on Hold / Background Music (BGM)

**[112] DSS Console Indication Mode**

Enables or disables the Busy Lamp Field (BLF) on the DSS button to indicate the status, Forward (FWD) or Do Not Disturb (DND), of corresponding extensions.



- \* Enable: FWD – Flashing slowly, DND – Flashing moderately
- Disable: FWD – Off, DND – Off

**Default** Enable



- **Feature Reference**  
Section 3, Features  
DSS Console

**[113] Automatic Redial Repeat**

Selects the number of times Automatic Redial is repeated.

(0/3/10/  
15 times)

**Default** 10 times



- **Feature Reference**  
Section 3, Features  
Redial

**[114] Automatic Redial Interval Time**

Selects the interval time between Automatic Redial attempts.

(40/60 sec)

**Default** 60 seconds



- **Feature Reference**  
Section 3, Features  
Redial

**[115] Extension Ringing Pattern Selection**

Selects the extension ringing pattern when an intercom call received, either **Single**, **Double** or **Triple**.

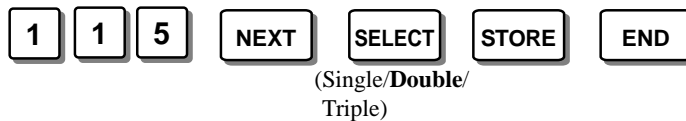
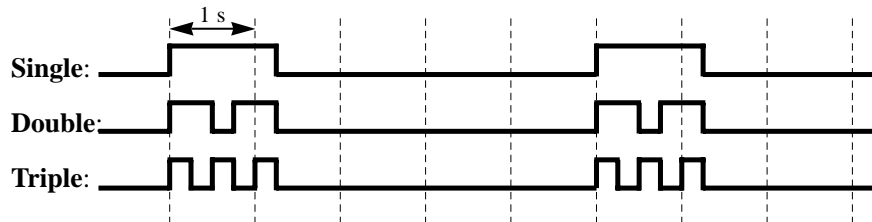

**Default** Double



- The length of the ring cycle for a single line telephone (SLT) is determined in program [124] “SLT Ring Mode Selection”.
- The extension ringback pattern is determined at the same time.



- **Feature Reference**  
Section 3, Features  
Ringing Pattern Selection

**[116] Conference Pattern Selection**

Selects the maximum number of external parties which can attend a conference. The maximum number of conference parties is 5.

**3-party C-0 E-3:** No external parties can attend a 3-party conference.

**3-party C-1 E-3:** One external party can attend a 3-party conference.

**3-party C-2 E-3:** A maximum of 2 external parties can attend a 3-party conference.

**5-party C-2 E-5:** A maximum of 2 external parties can attend a 5-party conference.

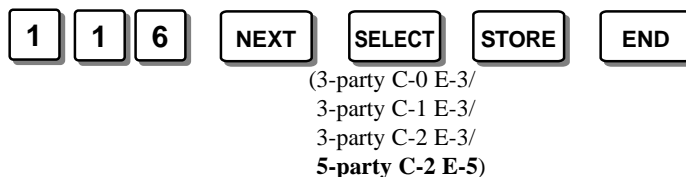

**Default** 5-party C-2 E-5



- **Feature References**  
Section 3, Features  
Conference (3-Party), Conference (5-Party)

**[117] *Call Pickup Tone***

Enables or disables the confirmation tone when the Call Pickup feature is activated.

(Enable/  
Disable)

**Default**    Enable



- **Feature Reference**  
     Section 3, Features  
     Call Pickup

**[118] *Pulse Restriction***

Enables or disables sending pulse dialing to the Central Office during a conversation with an external party when “Pulse Mode” or “Call Block Mode” is selected in program [401] “Dial Mode”.

(Enable/  
Disable)

**Default**    Enable

**[119] *Redialing after Pulse to Tone Conversion***

Enables or disables sending tone dialing to the Central Office when an extension user redial after changing the pulse mode into tone mode by pressing \* and #.

(Enable/  
**Disable**)

**Default**    Disable



- **Feature Reference**  
     Section 3, Features  
     Pulse to Tone Conversion

**[120] Bell Frequency**

Selects the bell frequency sent to a single line telephone (SLT).

1 2 0 NEXT SELECT STORE END  
(20/25 Hz)

**Default** 25 Hz

**[121] Automatic Outside (CO) Line Access Number Selection**

Selects the Automatic Outside (CO) Line Access number ( 0 or 9).

1 2 1 NEXT SELECT STORE END  
(0/9)

**Default** 9



- If you select “0”, the operator call will automatically be “9”. If you select “9”, the operator call will automatically be “0”



- **Feature References**

Section 3, Features

Automatic Outside (CO) Line Access Number, Operator Call

**[122] Automatic Rotation for Outside (CO) Line Access**

Enables or disables the rotation of outside (CO) lines seized for “Automatic Outside (CO) Line Access”.

1 2 2 NEXT SELECT STORE END  
(Enable  
Disable)

**Default** Disable (Does not rotate.)



- **Feature Reference**

Section 3, Features

Automatic Outside (CO) Line Access Number

**[123] Break Ratio**

Selects the pulse break rate, **MODE1** or **MODE 2**, when a Pulse is sent to the Central Office during a conversation.

**MODE 1:** 66 %

**MODE 2:** 60 %

(MODE1/  
MODE2)

**Default**      MODE 2

**[124] SLT Ringing Mode Selection**

Selects the length of the ring cycle for a single line telephone (SLT).

**MODE 1:** 5 second cycle

**MODE 2:** 3 second cycle

(MODE1/  
MODE2)

**Default**      MODE 1

**[125] Toll Restriction Check for \* and #**

Assigns whether the entered "\*" and "#" are checked by toll restriction or not. This assignment is required for certain Central Offices to prevent toll fraud. Some Central Offices ignore the user-dialed "\*" and "#". If your Central Office ignores these symbols, select "Disable".

(Enable/  
Disable)

**Default**      Enable



- **Feature Reference**  
Section 3, Features  
Toll Restriction

**[200] Hold Recall Time**

Assigns the length of the hold recall timer. Hold recall (a ring tone or an alarm tone) is heard when the timer expires. If hold recall is not required, select “Disable”.

**2** **0** **0** **NEXT** **SELECT** **STORE** **END**

(30 sec/  
1/1.5/2/3/4/5/6 min/  
Disable)

**Default** 30 seconds



- **Feature References**  
Section 3, Features  
Call Park, Hold

**[201] Transfer Recall Time**

Assigns the length of the transfer recall timer. If a transferred call is not answered within the programmed time, the call will be returned to the original caller.

**2** **0** **1** **NEXT** **SELECT** **STORE** **END**

(15/30 sec/  
1/2 min)

**Default** 30 seconds



- **Feature Reference**  
Section 3, Features  
Call Transfer – to Extension

**[202] Call Forwarding Start Time**

Assigns time for the Call Forwarding – No Answer feature. If a call is not answered within the programmed time, the call will be forwarded to the destination.

**2** **0** **2** **NEXT** **SELECT** **STORE** **END**

(5/10/15/20  
sec delay)

**Default** 15 seconds delay



- **Feature Reference**  
Section 3, Features  
Call Forwarding

### [203] Pickup Dial Delay Time

Assigns the length of time for the Pickup Dialing feature. If the telephone user lifts the handset, the programmed party is called automatically when the timer expires. This delay gives the user an opportunity to enter numbers before automatic dialing occurs.

(1/2/3/4 sec)

**Default** 3 seconds



- **Feature Reference**  
 Section 3, Features  
 Pickup Dialing

### [204] Call Duration Count Start Time

Assigns the start time of a conversation either immediately after an outside (CO) line is seized or after dialing. This corresponds to the length of the conversation displayed on the LCD and printed on the printer (SMDR).

(5/10/15/20/25/30/  
 35/40/45/50 sec after  
 dial/Instantly)

**Default** 10 seconds after dial



- If reverse signal detection is enabled in program [424] “Reverse (Polarity) Circuit Assignment”, the system will automatically start the timer immediately after an external party answers a call.



- **Feature References**  
 Section 3, Features  
 Polarity Reverse Detection, Station Message Detail Recording (SMDR)

**[205] *Outside-to-Outside (CO-to-CO) Line Duration Time Limit***

Sets the maximum time allowed for a conversation between two external parties using the Call Forwarding – to Outside (CO) Line, Call Transfer – to Outside (CO) Line, Unattended Conference feature, or the DISA feature. When the timer expires, the outside-to-outside line call is disconnected.

**2** **0** **5** **NEXT** **time** **STORE** **END**  
 (1--32 min)

**Default** 10 minutes



- **Feature Reference**  
 Section 3, Features  
 Limited Call Duration

**[206] *Dialing Start Time***

Assigns the minimum length of the pause time the system waits before dialing after seizing an outside (CO) line.

**2** **0** **6** **NEXT** **SELECT** **STORE** **END**  
 (0/250/500/750/  
 1000/1250/1500 ms)

**Default** 0 millisecond



- **Feature Reference**  
 Section 3, Features  
 Outside Calling

**[207] Hookswitch Flash Timing Range Selection**

Sets the hookswitch flash time range sent from an extension to the system.

- MODE 1:** 50 to 180 milliseconds.
- MODE 2:** 80 to 180 milliseconds.
- MODE 3:** 80 to 650 milliseconds.
- MODE 4:** 80 to 1000 milliseconds.
- MODE 5:** 200 to 1000 milliseconds.

**2 0 7**   **NEXT**   **SELECT**   **STORE**   **END**

(MODE1/MODE2/  
MODE3/MODE4/  
MODE5)

**Default**    MODE 4



- **Feature Reference**  
Section 3, Features  
Hookswitch Flash

**[208] Interdigit Time**

Assigns the maximum time allowed between digits for an outgoing outside call.

**2 0 8**   **NEXT**   **SELECT**   **STORE**   **END**

(5/10/15 sec)

**Default**    10 seconds



- The interdigit timer applies until the toll restriction check is completed. When the timer expires, an outgoing outside call will be disconnected while dialing, if “Enable” was selected in program [211] “No Dial Disconnection”.
- For a single line telephone, an outgoing outside call will be released from a DTMF receiver when the interdigit timer expires.



- **Feature Reference**  
Section 3, Features  
Toll Restriction

**[210] *DTMF Time***

Assigns the minimum duration of a DTMF signal sent to an outside (CO) line which is set to the DTMF mode in program [401] “Dial Mode”.

**MODE 1:** 80 milliseconds

**MODE 2:** 160 milliseconds

(MODE1/  
MODE2)

**Default**    MODE 1

**[211] *No Dial Disconnection***

Enables or disables disconnecting an outside (CO) line if an extension user does not dial anything within 10 seconds after an outside (CO) line is seized.

(Enable/  
Disable)

**Default**    Disable (Does not disconnect)

- The interdigit timer assigned in program [208] “Interdigit Time” applies until the toll restriction check is completed. When the timer expires, an outgoing outside call will be disconnected while dialing, if “Enable” was selected in this program.



- **Feature Reference**  
     Section 3, Features  
     Toll Restriction

**[212] *Outside (CO) Line Duration Time Limit***

Sets the maximum time allowed for a conversation with an external party. This program is effective for the extension(s) which assigned “Enable” in program [613] “Outside (CO) Line Duration Limit Selection”.

2
1
2
NEXT
time
STORE
END  
 (1-32 minutes)

**Default**    10 minutes



- A beep sounds at 5-second intervals 15 seconds before the programmed time expires.
- This program is effective only for an outgoing outside call.
- When making a call after an outside (CO) line is seized and transferred to the enabled extension in program [613] by another extension, the timer starts after the call has been transferred.



- **Feature Reference**  
 Section 3, Features  
 Limited Call Duration

**[213] *Bell Off Detection***

Sets the maximum time between detecting one bell signal and the next from the Central Office. In case the next bell signal is not detected within the programmed time, the system recognizes the bell signal has stopped.

2
1
3
NEXT
SELECT
STORE
END  
 (3/6/12 sec)

**Default**    6 seconds

**[300] Carrier Code Assignment**

Assigns up to 20 carrier codes. This allows the system to recognize the special user-dialed carrier code. The system disregards the assigned code and toll restriction is applied to the numbers after the code.

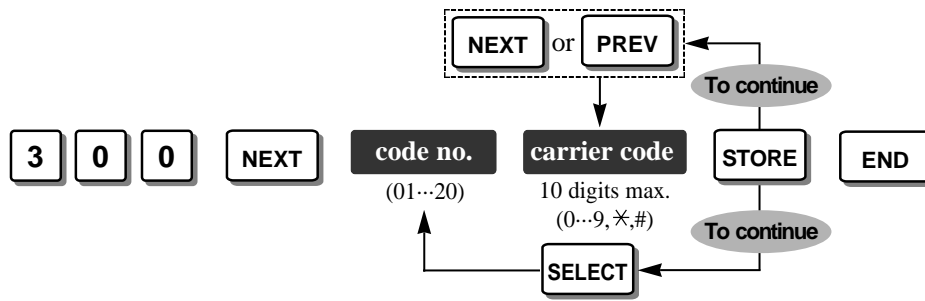

**Default** All codes – Not stored.



- “x” (press the PAUSE button) substitutes any number (= wild card).
- To correct a wrong entry, press the CLEAR button and enter the new one.

**[301] Toll Restriction – System Speed Dialing Boundary Class**

Assigns the toll restriction class for System Speed Dialing numbers. System Speed Dialing numbers can be assigned in program [001] “System Speed Dialing Entry”.

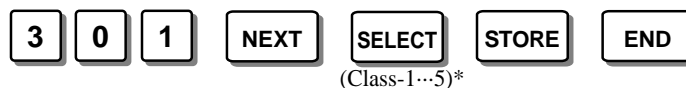

\* Boundary Class: 1 through 5

**Default** Boundary Class -1



- **Feature Reference**  
 Section 3, Features  
 Toll Restriction for System Speed Dialing

**[302]-[305] Toll Restriction – Classes 2 through 5 Denied Codes**

Assigns up to 20 toll call numbers which are restricted to make an outside (CO) calls on a class of service (COS) basis for each program.

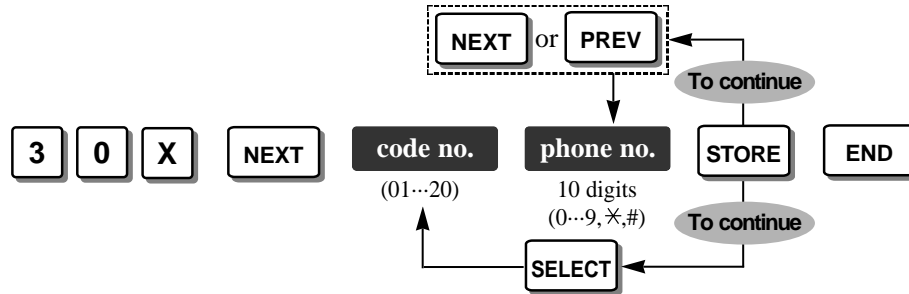

**X** – Program address selection number: 2 ([302] for Class 2) / 3 ([303] for Class 3) / 4 ([304] for Class 4) / 5 ([305] for Class 5)

**Default** All codes – Not stored.



- “x” (press the PAUSE button) substitutes any number (= wild card).
- Each phone number should consist of 10 digits.
- To correct a wrong entry, press the CLEAR button and enter the new one.



- **Feature Reference**  
Section 3, Features  
Toll Restriction

**[306] Toll Restriction – Exception Codes**

Assigns up to 20 exception numbers which are allowed to make an outside (CO) calls on a class of service (COS) basis even when denied codes are programmed in [302]-[305] “Toll Restriction – Classes 2 through 5 Denied Codes”.

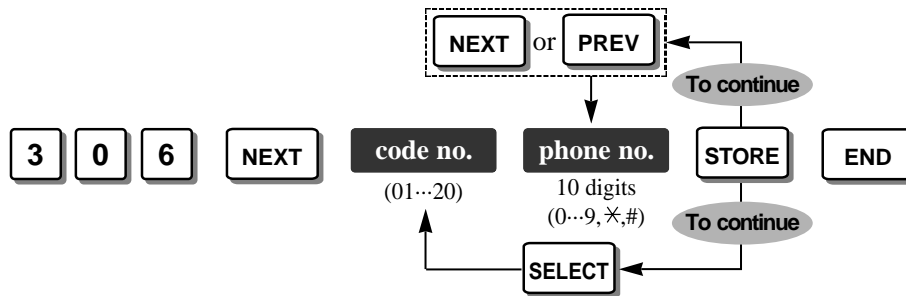

**Default** All codes – Not stored.



- “x” (press the PAUSE button) substitutes any number (= wild card).
- Each phone number should consist of 10 digits.
- To correct a wrong entry, press the CLEAR button and enter the new one.



- **Feature Reference**  
Section 3, Features  
Toll Restriction

**[309] Emergency Dial Number Set**

Assigns up to 5 emergency call numbers, for example, a police station or fire station. These numbers are free from restrictions, for example, toll restriction, Account Code – Forced/Verify mode or Electronic Station Lock.

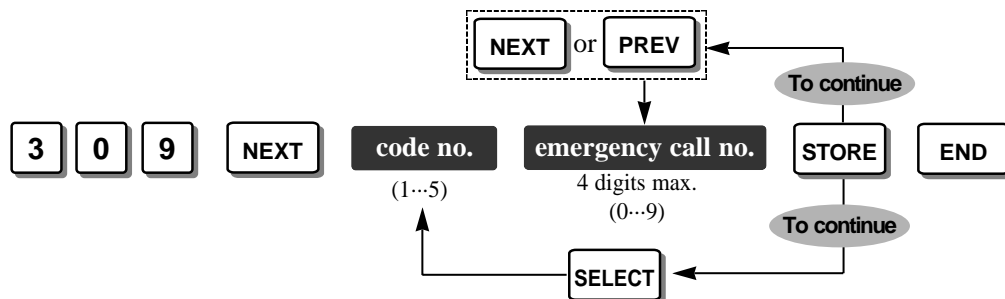

**Default** All codes – Not stored.



- To correct a wrong entry, press the CLEAR button and enter the new one.



- **Feature References**  
Section 3, Features  
Emergency Call, Toll Restriction

**[310] Account Codes**

Assigns up to 24 account codes which are compared with the code entered when “Verify” is selected in program [605] “Account Code Entry Mode”. When one of the account codes is the same as the entered code, an outside call can be made.

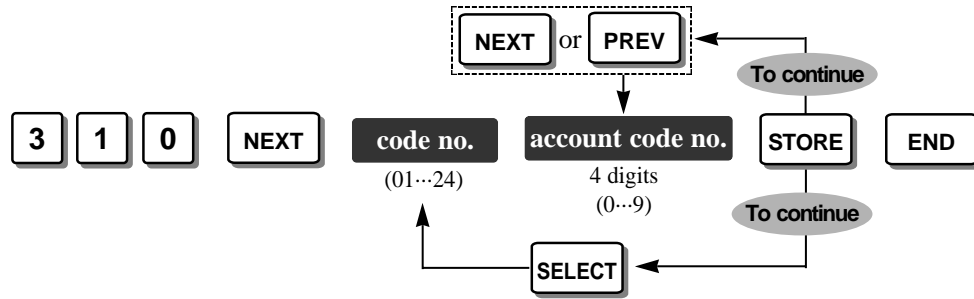

**Default** All codes – Not stored.



- To correct a wrong entry, press the CLEAR button and enter the new one.



**Feature References**

Section 3, Features

Account Code Entry, Toll Restriction Override by Extension Password

**[311] Automatic Pause Insertion Codes**

Assigns up to 40 automatic pause insertion codes which are checked with the outside outgoing call number. When one of the codes is the same as the call number, the pause time assigned in program [417] “Pause Time” is automatically inserted after the code. If a second dial tone is sent from your Central Office, it is convenient to assign the area code as the pause code number.

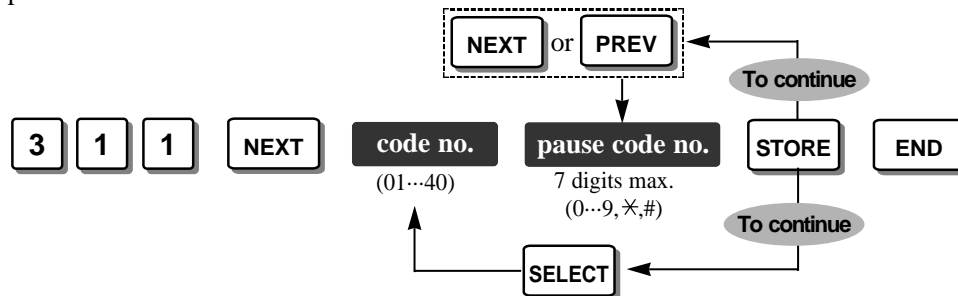

**Default** All codes – Not stored.



- To correct a wrong entry, press the CLEAR button and enter the new one.

**[312] Toll Restriction – Station Lock Boundary Class**

Assigns the Toll Restriction class for an extension which has set the Electronic Station Lockout or Remote Station Lock Control.

**3** **1** **2** **NEXT** **SELECT** **STORE** **END**

(Disable/  
COS-2..5)\*

\* Boundary COS: 2 through 5 / Disable (Disables all outside outgoing calls.)

**Default**    Disable



• **Feature Reference**

**Section 3, Features**

Toll Restriction — Station Lock Boundary Class

**[400] Outside (CO) Line Connection Assignment**

Assigns which outside (CO) line(s) is connected to the system or not.

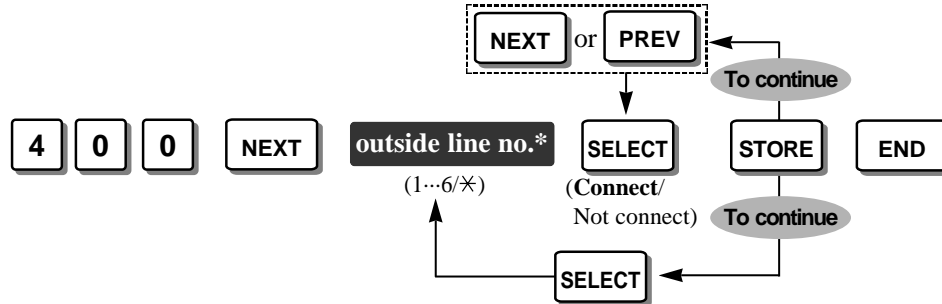

\* Outside (CO) line number: 1 through 6 / \* (All outside lines)

**Default** All outside (CO) lines – Connect



- **Feature Reference**  
Section 3, Features  
Outside Calling

**[401] Dial Mode**

Selects the dialing mode, **DTMF**, **Pulse** or **C. BLK** (Call Blocking), for each outside (CO) line.

**DTMF:** The dialing signals from an extension, either Tone or Pulse, are converted to Tone and transmitted to the Central Office. If the system is connected directly to the Central Office or installed behind a host PBX, which receives both Tone and Pulse, select this mode.

**Pulse :** The dialing signals from an extension, either Tone or Pulse, are converted to Pulse and transmitted to the Central Office.

**C. BLK:** If your Central Office can receive both DTMF and Pulse signals but the user are contracted for Pulse, select this mode. When dialing with a touch tone telephone, only Pulse signals are sent to the Central Office.

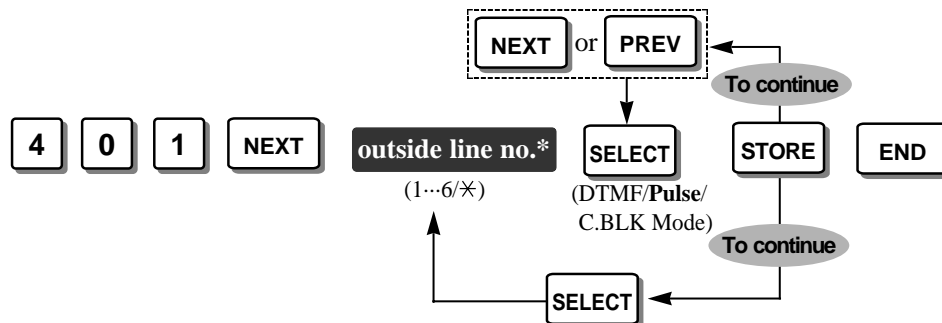

\* Outside (CO) line number: 1 through 6 / \* (All outside lines)

**Default** All outside (CO) lines – Pulse Mode



- **Feature Reference**  
Section 3, Features  
Pulse to Tone Conversion

**[402] Pulse Speed Selection**

Selects a pulse rate for each outside (CO) line which sets “Pulse Mode” or “Call block Mode” in program [401] “Dial Mode”. There are 2 pulse rates, **Low Speed** (10 pps) and **High Speed** (20 pps).

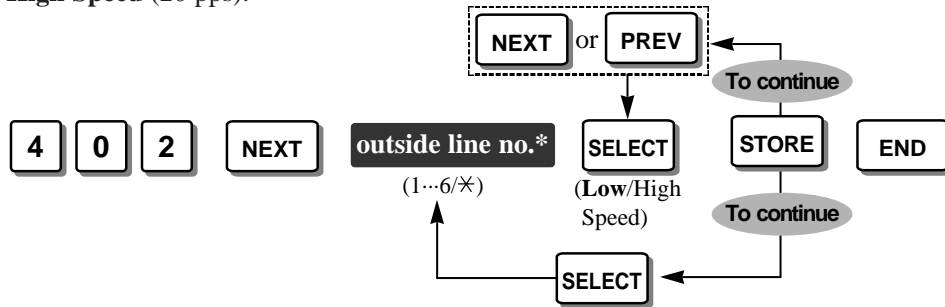

\* Outside (CO) line number: 1 through 6 / \* (All outside lines)

**Default** All outside (CO) lines – Low Speed

**[403] Host PBX Access Codes**

If the system is installed behind a host PBX, each outside (CO) line may require an access code to make an outside call. Up to 8 access codes can be stored for each outside line. When the programmed codes are dialed, the pause time assigned in program [417] “Pause Time” is automatically inserted, and toll restriction is applied after the code.

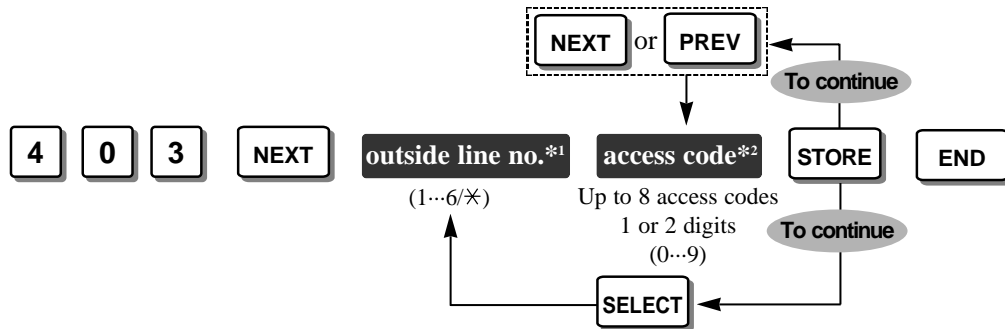

\*1 Outside (CO) line number: 1 through 6 / \* (All outside lines)

\*2 Insert a “,” for each code using the  button on the overlay.

**Example:**

- Access codes 81, 82 on outside (CO) line number 1

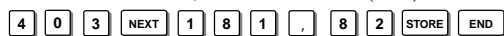

**Default** All outside (CO) lines – Not stored



- To correct a wrong entry, press the CLEAR button and enter the new one.



- **Feature Reference**  
Section 3, Features  
Host PBX Access

**[404] Outside (CO) Line Group Assignment**

Assigns a maximum 6 outside (CO) line groups. Each outside (CO) line must be assigned to an outside (CO) line group. For example, if there are multiple telephone service companies available, outside (CO) lines can be grouped by the company.

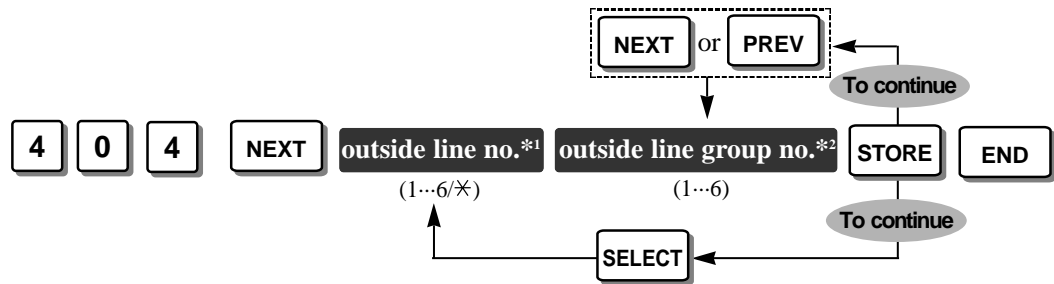

\*1 Outside (CO) line number: 1 through 6 / \* (All outside lines)

\*2 Outside line (TRK) group number: 1 through 6

**Default** Outside (CO) line 1 through 6 – Outside (CO) line group 1 through 6



- Each outside (CO) line can only belong to one outside (CO) line group.



- **Feature Reference**  
Section 3, Features  
Outside Calling

**[405]-[407] Flexible Outward Dialing Assignment —Day/Night/Lunch**

Determines which extension(s) can make an outside call in the day, night and/or lunch modes.

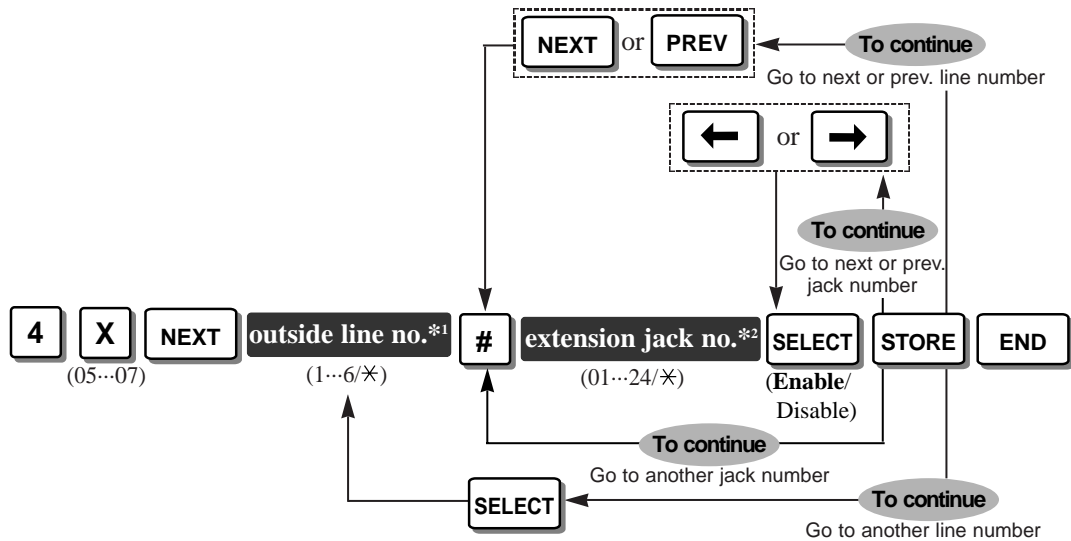

**X** – Program address selection number: 05 ([405] for day) / 06 ([406] for night) / 07 ([407] for lunch)

\*<sup>1</sup> Outside (CO) line number: 1 through 6 / \* (All outside lines)

\*<sup>2</sup> Extension jack number: 01 through 24 / \* (All extension jacks)

**Default** All outside (CO) lines – all extension jacks – Enable



- **Feature Reference**  
Section 3, Features  
Outside Calling

**[408]-[410] Flexible Ringing Assignment —Day/Night/Lunch**

Determines which extension(s) will ring for incoming outside calls in the day, night and/or lunch modes.

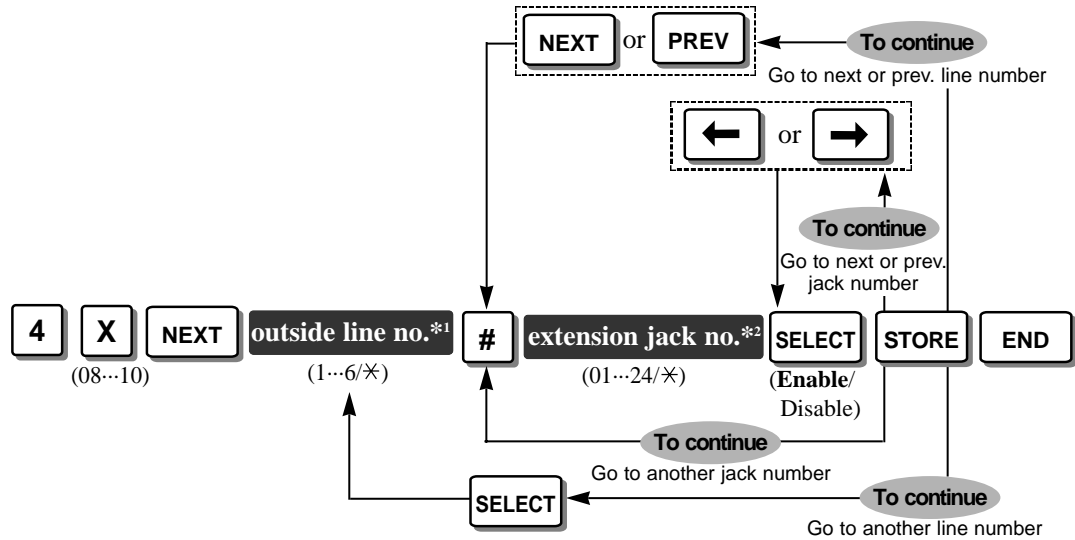

**X** – Program address selection number: 08 ([408] for day) / 09 ([409] for night) / 10 ([410] for lunch)

\*1 Outside (CO) line number: 1 through 6 / \* (All outside lines)

\*2 Extension jack number: 01 through 24 / \* (All extension jacks)

**Default** All outside (CO) lines – all extension jacks – Enable



• **Feature References**

**Section 3, Features**

Outside (CO) Line Ringing Selection, Uniform Call Distribution (UCD), Receiving Calls

**[411]-[413] Delayed Ringing Assignment —Day/Night/Lunch**

Assigns the ringing start time for extension(s) which were selected to ring in programs [408]-[410] “Flexible Ringing Assignment —Day/Night/Lunch” in the day, night and/or lunch modes.

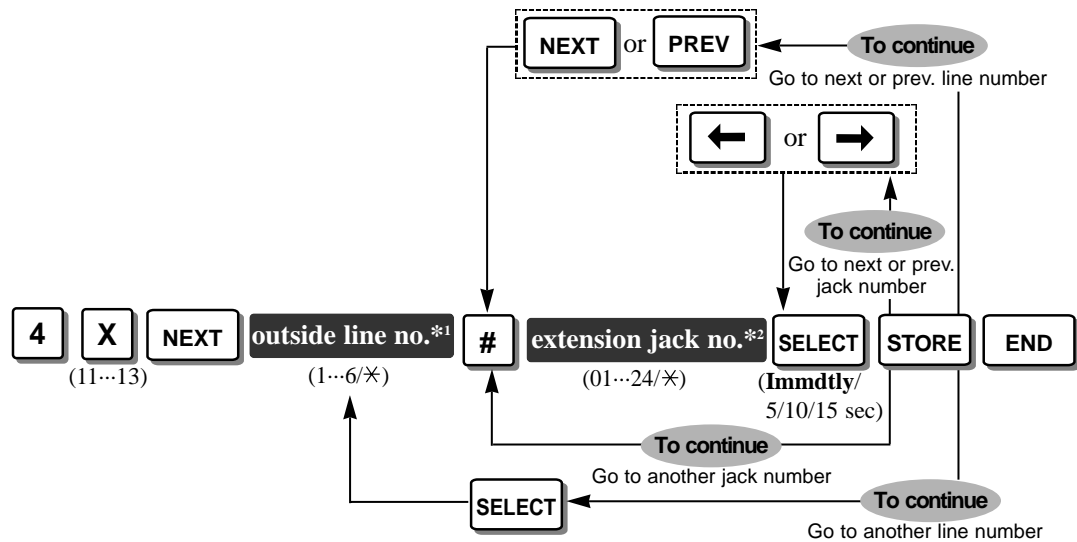

**X** – Program address selection number: 11 ([411] for day) / 12 ([412] for night) / 13 ([413] for lunch)

\*<sup>1</sup> Outside (CO) line number: 1 through 6 / \* (All outside lines)

\*<sup>2</sup> Extension jack number: 01 through 24 / \* (All extension jacks)

**Default** All outside (CO) lines – all extension jacks – Immediately



- **Feature Reference**  
 Section 3, Features  
 Receiving Calls

**[414]-[416] Outside (CO) Line Mode —Day/Night/Lunch**

Selects the mode of an incoming outside call on each outside (CO) line in the day, night and lunch modes. There are the following 5 modes.

- Normal:** An incoming outside call will be received at the extension(s) assigned in programs [408]–[410] “Flexible Ringing Assignment — Day/Night/Lunch”.
- DIL:** An incoming outside call will be received at the assigned extension in this program.
- DISA1:** An incoming outside call will be received at an extension through the DISA feature. A caller will hear a tone or an outgoing message.
- DISA2:** An incoming outside call will be received at an extension through the DISA feature. A caller will hear 2 different messages.
- UCD:** An incoming outside call will be received at an extension through the UCD feature.

< To select Normal, DISA and/or UCD >

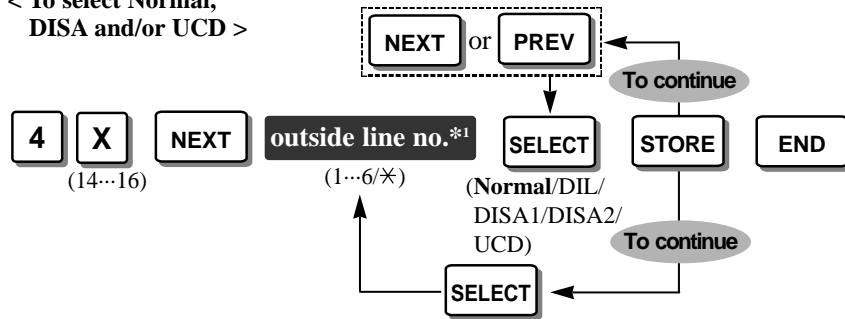

< To select DIL >

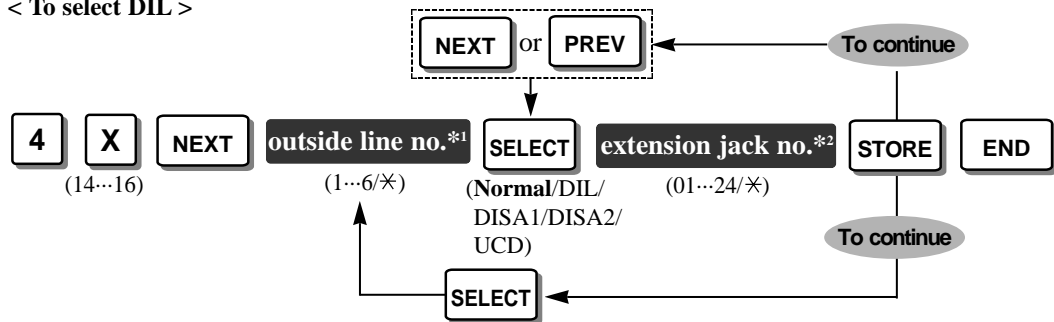

**X** – Program address selection number: 14 ([414] for day) / 15 ([415] for night) / 16 ([416] for lunch)

\*1 Outside (CO) line number: 1 through 6 / \* (All outside lines)

\*2 Extension jack number: 01 through 24 / \* (All extension jacks)

**Default** All outside (CO) lines – Normal



- You must select “DISA1” when the optional OGM/FAX Detection card is not installed and if you want to use the internal DISA.
- When you select “UCD”, assign program [520] “UCD Group” to determine which extension group is assigned to the UCD group.
- When you select “DISA1”, “DISA2” and/or “UCD”, assign program [502] “OGM Selection” to determine which OGM will be used.



• **Feature References**

**Section 3, Features**

Direct In Line (DIL), Direct Inward System Access (DISA),  
Outgoing Message (OGM), Uniform Call Distribution (UCD)

**[417] Pause Time**

Assigns the length of the pause time. The programmed pause time is automatically inserted after a line access code, a host PBX access code programmed in [403] “Host PBX Access Codes” or a pause code assigned in [311] “Automatic Pause Insertion Codes” or can be manually inserted by the user using the PAUSE button.

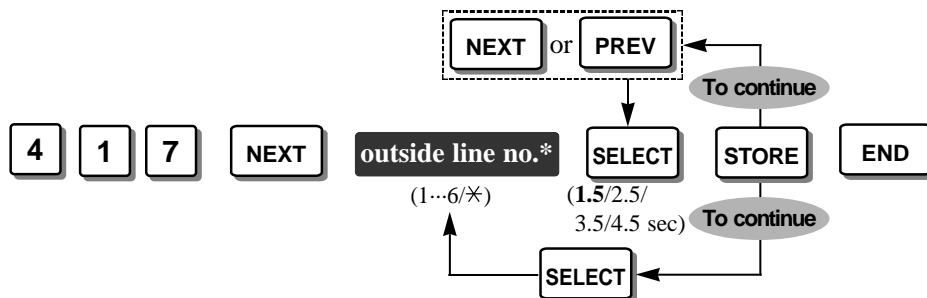

\* Outside (CO) line number: 1 through 6 / \* (All outside lines)

**Default** All outside (CO) lines – 1.5 seconds



• **Feature Reference**

**Section 3, Features**  
Host PBX Access

**[418] Flash Time**

Assigns the length of the flash time. If your system is installed behind a host PBX, External Feature Access is necessary to obtain its services. To enable it, select the required flash signal sending time for an outside (CO) line.

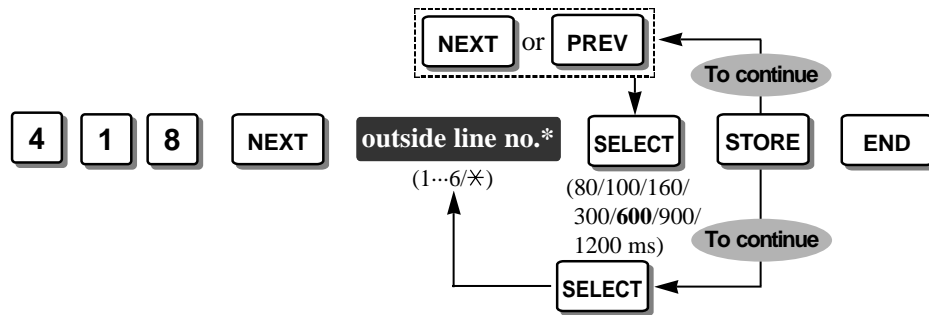

\* Outside (CO) line number: 1 through 6 / \* (All outside lines)

**Default** All outside (CO) lines – 600 milliseconds



- **Feature References**  
Section 3, Features  
External Feature Access, Flash

**[419] Automatic Designated Outside (CO) Line Access**

Selects which outside (CO) line is seized automatically when an extension user dial the Automatic Line Access number (0 or 9) assigned in program [121] “Automatic Outside (CO) Line Access Number Selection”.

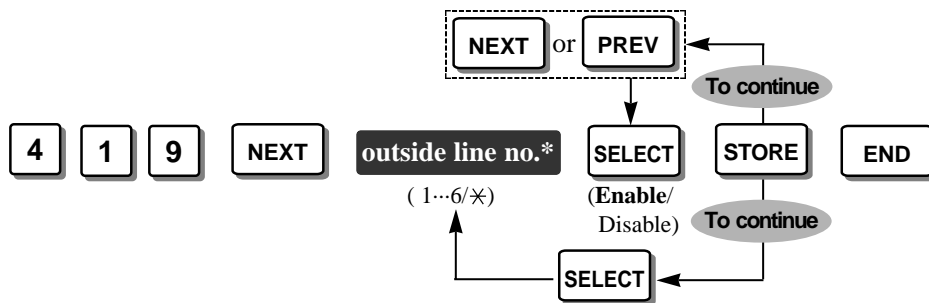

\* Outside (CO) line number: 1 through 6 / \* (All outside lines)

**Default** All outside (CO) lines – Enable



- **Feature References**  
Section 3, Features  
Automatic Outside (CO) Line Access Number, Outside Calling

[420] Calling Party Control (CPC) Signal

Assigns the required minimum duration of the Calling Party Control (CPC) signal from the Central Office for incoming outside calls. If programmed, the system disconnects the line when the CPC signal is detected.

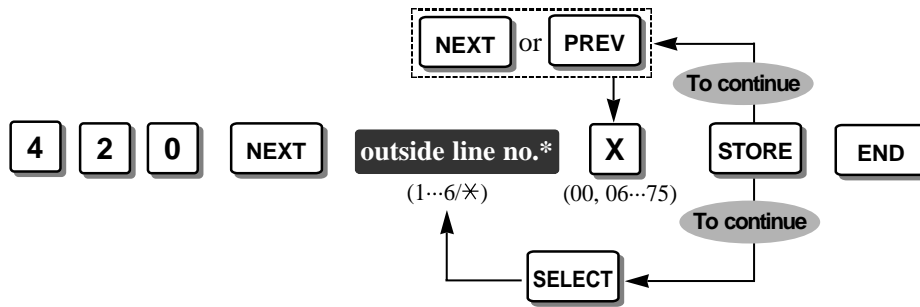

\* Outside (CO) line number: 1 through 6 / \* (All outside lines)

X – CPC signal detect time selection number: No. = selection number  
Detect time (milliseconds)

| No.     | Detect time | No. | Detect time | No. | Detect time | No. | Detect time |
|---------|-------------|-----|-------------|-----|-------------|-----|-------------|
| 00      | Disable     | 23  | 198         | 42  | <b>350</b>  | 61  | 502         |
| 01 - 05 | Cannot use  | 24  | 206         | 43  | 358         | 62  | 510         |
| 06      | 62          | 25  | 214         | 44  | 366         | 63  | 518         |
| 07      | 70          | 26  | 222         | 45  | 374         | 64  | 526         |
| 08      | 78          | 27  | 230         | 46  | 382         | 65  | 534         |
| 09      | 86          | 28  | 238         | 47  | 390         | 66  | 542         |
| 10      | 94          | 29  | 246         | 48  | 398         | 67  | 550         |
| 11      | 102         | 30  | 254         | 49  | 406         | 68  | 558         |
| 12      | 110         | 31  | 262         | 50  | 414         | 69  | 566         |
| 13      | 118         | 32  | 270         | 51  | 422         | 70  | 574         |
| 14      | 126         | 33  | 278         | 52  | 430         | 71  | 582         |
| 15      | 134         | 34  | 286         | 53  | 438         | 72  | 590         |
| 16      | 142         | 35  | 294         | 54  | 446         | 73  | 598         |
| 17      | 150         | 36  | 302         | 55  | 454         | 74  | 606         |
| 18      | 158         | 37  | 310         | 56  | 462         | 75  | 614         |
| 19      | 166         | 38  | 318         | 57  | 470         |     |             |
| 20      | 174         | 39  | 326         | 58  | 478         |     |             |
| 21      | 182         | 40  | 334         | 59  | 486         |     |             |
| 22      | 190         | 41  | 342         | 60  | 494         |     |             |

**Default** All outside (CO) lines – 350 milliseconds (No. 42)



• Feature Reference

Section 3, Features

Calling Party Control (CPC) Signal Detection

**[421] CPC Detection for Outgoing Calls**

Enables or disables the CPC signal detection during an outgoing outside call. If disabled, the CPC signal detection is only activated during an incoming outside call or after call hold.

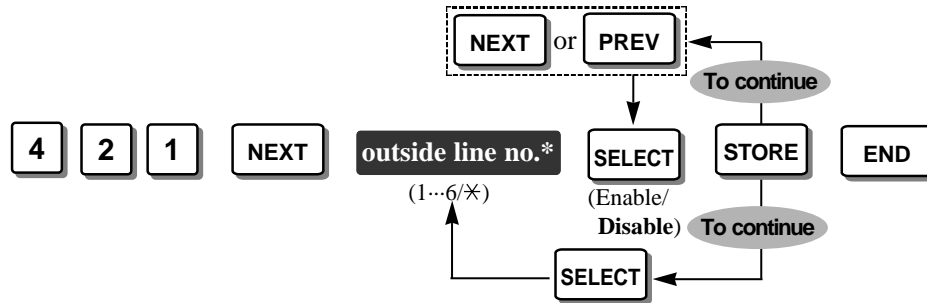

\* Outside (CO) line number: 1 through 6 / \* (All outside lines)

**Default** All outside (CO) lines – Disable



- **Feature Reference**  
Section 3, Features  
Calling Party Control (CPC) Signal Detection

**[422] Disconnect Time**

Determines the amount of time to send the disconnect signal from the system to the Central Office or host PBX. The time you select must be longer than the requirements of your Central Office or host PBX.

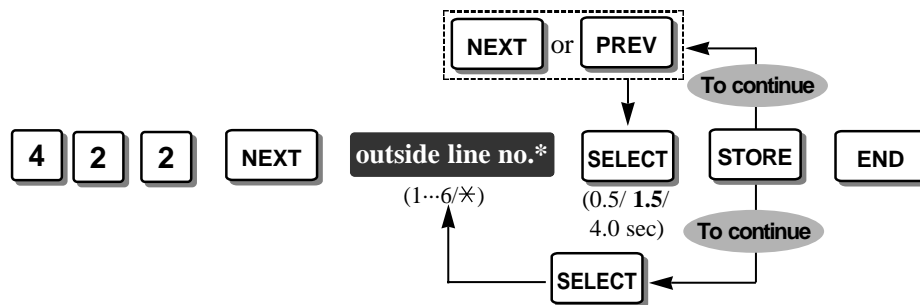

\* Outside (CO) line number: 1 through 6 / \* (All outside lines)

**Default** All outside (CO) lines – 1.5 seconds



- **Feature Reference**  
Section 3, Features  
Flash

[423] Outside (CO) Line Ringing Pattern Selection

Selects the incoming outside call ringing pattern, **Single**, **Double** or **Triple**, for each outside (CO) line. This is useful for distinguishing private calls from business calls.

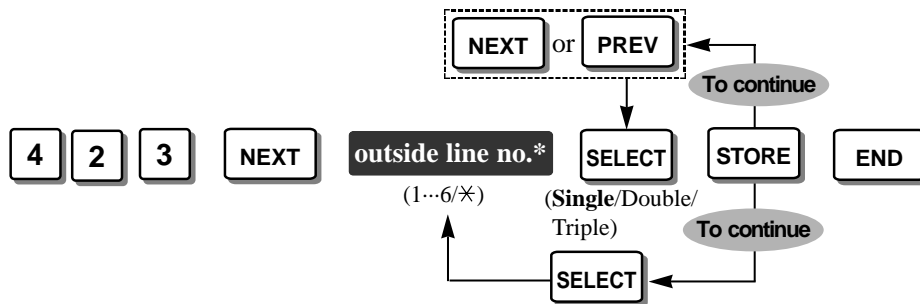
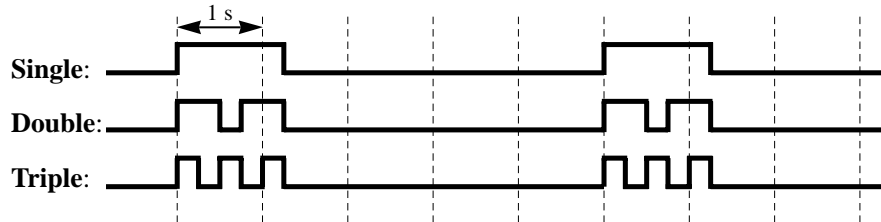

\* Outside (CO) line number: 1 through 6 / \* (All outside lines)

**Default** All outside (CO) lines – Single

- ! We recommend assigning this program regarding the extension ringing pattern assigned in program [115] “Extension Ringing Pattern Selection” and doorphone ringing pattern assigned in program [706] “Doorphone Ringing Tone Selection”



- **Feature Reference**  
Section 3, Features  
Ringing Pattern Selection

**[424] Reverse (Polarity) Circuit Assignment**

Enables or disables detecting the reverse signal for each outside (CO) line's polarity from the Central Office when making a call. If enabled, the outside call duration can be determined.

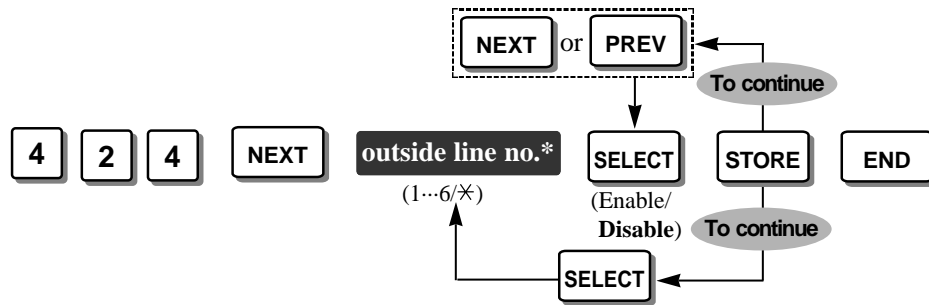

\* Outside (CO) line number: 1 through 6 / × (All outside lines)

**Default** All outside (CO) lines – Disable



- **Feature Reference**  
 Section 3, Features  
 Polarity Reverse Detection

**[500] DISA Incoming Dialing Mode Selection**

Selects the destination of an incoming outside call via the DISA feature when you select “DISA 1” or “DISA 2” in programs [414]-[416] “Outside (CO) Line Mode –Day/Night/Lunch”, **Without AA** (auto attendant) or **With AA** . If you select “With AA”, assign the next program [501] “DISA Built-in Auto Attendant”.

**Without AA:** Available destinations are: extension numbers assigned in program [009] “Extension Number Assignment”, line access numbers (0 or 9, 81 through 86) and the operator number (0 or 9).

**With AA:** Available destinations are: numbers available in the “Without AA” mode, and numbers (0 through 9) assigned in program [501].



(Without AA/  
With AA)

**Default** Without AA



- For example: in the “With AA” mode, if a number is not dialed within the programmed time in [517] “DISA AA Wait Time” after dialing 1, the call is received at the DISA built-in auto attendant number 1.
- In the “With AA” mode, if 0 and/or 9 are not assigned in program [501], the system recognizes them as a line access number and/or operator number.



- **Feature Reference**

Section 3, Features

Direct Inward System Access (DISA)

**[501] DISA Built-in Auto Attendant**

Assigns a maximum of 10 DISA built-in auto attendant numbers when “With AA” is selected in program [500] “DISA Incoming Dialing Mode Selection”. The extension numbers assigned in program [009] “Extension Number Assignment”, and the extension group numbers assigned in program [600] “Extension Group Assignment” can be assigned as a 1 digit number and used as DISA built-in auto attendant numbers.

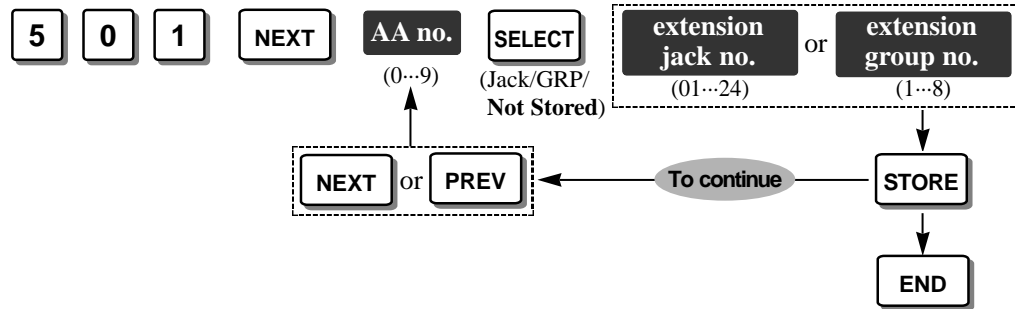

**Default** All auto attendant numbers – Not stored



- If you would like to use a line access number and/or operator number in the “With AA” mode, do not assign auto attendant number(s) which correspond to a line access number and/or operator number (0 and/or 9).



- **Feature Reference**  
 Section 3, Features  
 Direct Inward System Access (DISA)

**[502] OGM Mode Selection**

Selects how the 2 outgoing messages (OGM1 and OGM2) are used, **MODE1** through **MODE5**.

| Mode | OGM1  | OGM2    | Description  |
|------|-------|---------|--|
| 1    | DISA1 | DISA1   | The system can receive 2 incoming calls via the DISA feature at the same time. This is useful when receiving many calls.             |
| 2    | DISA1 | DISA2   | An example: DISA1 is used in the day mode and DISA2 is used in the night mode.   |
| 3    | UCD   | UCD     | The system can hold up to 2 incoming calls via the UCD feature at the same time until any extension is available.                    |
| 4    | UCD   | UCD-END | The system disconnects an incoming call via the UCD feature when the assigned waiting time in [521] “UCD Busy Waiting Time” expires. |
| 5    | UCD   | DISA1   | An example: UCD is used in the day mode and DISA1 is used in the night mode.   |



**Default** MODE1



- Programs [414]-[416] “Outside (CO) Line Mode – Day/Night/Lunch” are used to assign “DISA1”, “DISA2” or “UCD” to each outside (CO) line according to this assignment. UCD-END is used automatically when UCD is assigned in programs [414]-[416], “Disconnect” is selected in program [523] “UCD Busy Mode”, and “MODE4” is selected in this program.
- If the optional OGM/FAX Detection card is not installed, this assignment should be “MODE1”.



• **Feature References**

**Section 3, Features**

Direct Inward System Access (DISA), Outgoing Message (OGM),  
Uniform Call Distribution (UCD)

### [503] FAX Connection \*1

Assigns one extension which can receive facsimile data when the system receives a FAX (CNG) tone via the DISA feature.

(01...24)

**Default**    Disable (Not assigned)



- The assigned extension will automatically have the Data Line Security feature set.
- To not assign an extension jack number, press the CLEAR button in the extension jack number step.



- **Feature References**  
 Section 3, Features  
 Data Line Security, Direct Inward System Access (DISA)

### [504] DISA Delayed Answer Time

Sets the time from a call being received and answered with the DISA feature.

(0/3/6/12 sec)

**Default**    3 seconds



- **Feature Reference**  
 Section 3, Features  
 Direct Inward System Access (DISA)

### [505] DISA Waiting Time after OGM \*1

Assigns the length of time the system keeps detecting the DTMF signals or FAX (CNG) tone after the DISA outgoing message is completed.

(0/5/10/15 sec)

**Default**    5 seconds



- **Feature Reference**  
 Section 3, Features  
 Direct Inward System Access (DISA)

\*1: Required only when the optional OGM/FAX Detection Card is installed.

**[506] DISA Busy Mode**

Selects the operation when a called extension or all called extensions in an extension group enabled in program [100] “Hunting Group Set” via the DISA feature is/are busy.

**Disconnect**, **Call Waiting** or **DISA2** is available.

**Disconnect:** The call is disconnected after the busy tone.

**Call Waiting:** A call waiting tone is sent to the called extension or first called extension in the hunting group.

**DISA2:** OGM2 is sent to the caller and the system waits for another destination when the first destination is busy.



(Disconnect/  
Call Waiting/  
DISA2)

**Default**    Disconnect



- Program [502] “OGM Mode Selection” should be “MODE2”, if “DISA2” was selected in this program.



• **Feature References**

Section 3, Features

Direct Inward System Access (DISA), Outgoing Message (OGM)

**[507] DISA Intercept Mode**

Selects the operation when a called extension or extension group via the DISA feature does not answer a call within the length of time programmed in [508] “DISA Ringing Time before Intercept”. **Intercept** or **Disconnect** is available.

**Intercept:** The call is redirected depending on [408]-[410] “Flexible Ringing Assignment–Day/Night/Lunch” (Intercept Routing – No Answer feature). This is useful for business use. For example, the call is forwarded to the operator or a Voice Processing System automatically.

**Disconnect:** The call is disconnected. This is useful for users who do not want to forward the call, for example, to a home.



(Intercept/  
Disconnect)

**Default**    Intercept



• **Feature References**

Section 3, Features

Direct Inward System Access (DISA), Intercept Routing, Voice Mail Integration

### [508] *DISA Ringing Time before Intercept*

Assigns the length of time for the Intercept Routing – No Answer feature (☞ [507] “DISA Intercept Mode”, Intercept). When the time expires the system starts to redirect the call to the programmed extension(s).

**5** **0** **8** **NEXT** **SELECT** **STORE** **END**

(10/20/30/  
40/60/120 sec)

**Default** 20 seconds



• **Feature References**

Section 3, Features

Direct Inward System Access (DISA), Intercept Routing

### [509] *DISA Ringing Time after Intercept*

Assigns the length of time to call the extension(s) where a call is redirected by the Intercept Routing – No Answer feature (☞ [507] “DISA Intercept Mode”, Intercept) after the time programmed in [508] “DISA Ringing Time before Intercept” expires. If the call is not answered within the programmed time, the call will be disconnected.

**5** **0** **9** **NEXT** **SELECT** **STORE** **END**

(10/20/30/  
40/60/120 sec)

**Default** 20 seconds



• **Feature References**

Section 3, Features

Direct Inward System Access (DISA), Intercept Routing

**[510] DISA No Dial Mode**

Selects the operation when the system does not receive either DTMF signals or a FAX (CNG) tone after a specified length of time programmed. If the optional card is installed, then use program [505] “DISA Waiting Time after OGM”. If the optional card is not installed, then use program [515] “Intercept Time for Internal DISA”. **Intercept** or **Disconnect** is available.

**Intercept:** The call is directed depending on programs [408]-[410] “Flexible Ringing Assignment–Day/Night/Lunch” (Intercept Routing – No Answer feature). The destination telephone(s) will ring for the time programmed in [509] “DISA Ringing Time after Intercept”.

**Disconnect:** The call is disconnected.

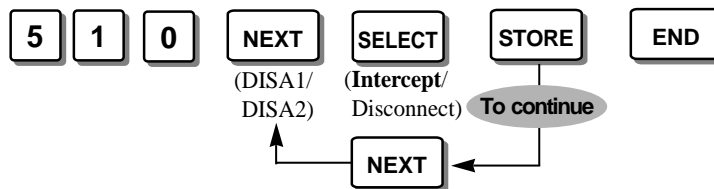

**Default** DISA 1 and DISA 2 – Intercept



- **Feature References**

Section 3, Features

Direct Inward System Access (DISA), Intercept Routing

**[511] DISA Security Type**

Selects the security mode for making calls attempted by a DISA caller. **Trunk Security** (outside (CO) line security), **All Security** or **None Security** is available.

**Trunk Security:** Requires the caller to enter a DISA security code assigned in program [512] “DISA Security Codes” before making an outside call.

**All Security:** Requires the caller to enter a DISA security code before making either an outside or intercom call.

**None Security:** Allows the caller to make both an outside and intercom call without entering a DISA security code.

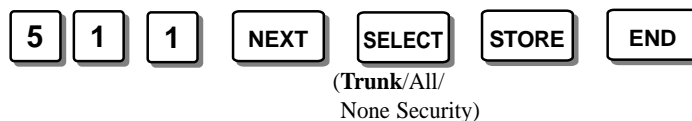

**Default** Trunk Security



- **Feature Reference**

Section 3, Features

Direct Inward System Access (DISA)

**[512] DISA Security Codes**

Assigns a maximum of 4 required DISA security codes if “Trunk Security” or “All Security” is selected in program [511] “DISA Security Type”.

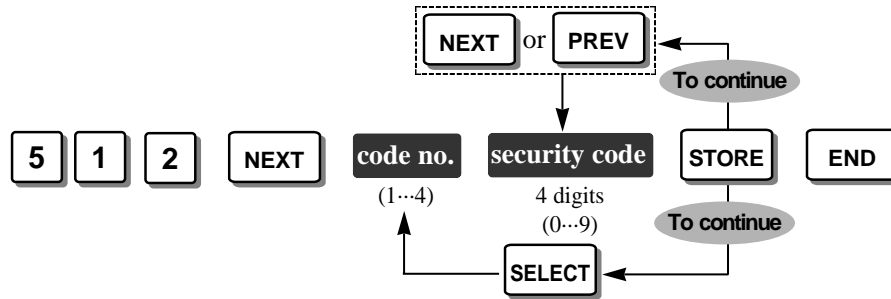

**Default** All DISA security codes – 0000

- ! • The used security codes are printed on the SMDR.
- ☞ • **Feature Reference**  
Section 3, Features  
Direct Inward System Access (DISA)

**[513] Cyclic Tone Detection\*<sup>1</sup>**

Assigns the number of times a cyclic tone is detected while the DISA outgoing message is sent so that the system can recognize the end of the DISA call.

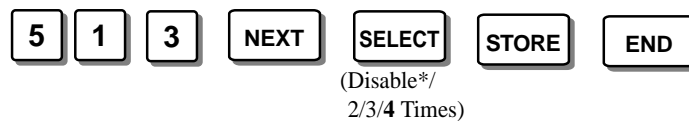

\* Disable (Does not detect)

**Default** 4 Times

- ☞ • **Feature References**  
Section 3, Features  
Direct Inward System Access (DISA), Uniform Call Distribution (UCD)

\*1: Required only when the optional OGM/FAX Detection Card is installed.

**[514] FAX Tone Detection\*<sup>1</sup>**

Sets the number of times the FAX (CNG) tone must be detected while the DISA outgoing message is sent before the system recognizes the incoming signal as facsimile data.

**5** **1** **4** **NEXT** **SELECT** **STORE** **END**  
 (1 Time/2 Times)

**Default** 1 Time



- The extension which can receive facsimile data must be assigned in program [503] "FAX Connection"



- **Feature Reference**  
 Section 3, Features  
 Direct Inward System Access (DISA)

**[515] Intercept Time for Internal DISA**

Assigns the length of time the system keeps detecting DTMF signals after a call is received at the internal DISA. If the system does not receive DTMF signals within the programmed time, the call will be intercepted or disconnected according to program [510] "DISA No Dial Mode".

**5** **1** **5** **NEXT** **SELECT** **STORE** **END**  
 (3/6/9 sec)

**Default** 3 seconds



- A cyclic tone and FAX (CNG) tone cannot be detected by the internal DISA.



- **Feature Reference**  
 Section 3, Features  
 Direct Inward System Access (DISA)

**[516] DISA Incoming Assignment**

Enables or disables each extension to receive an outside call via the DISA feature. If a DISA call is received at a disabled extension, the DISA caller will hear a reorder tone and the call will be disconnected automatically. For example, it may be convenient to disable the president’s extension.

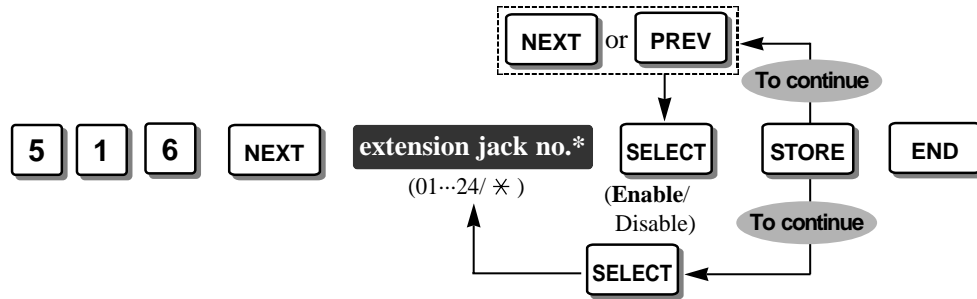

\* Extension jack number: 01 through 24 / ✕ (All extension jacks)

**Default** All extension jacks – Enable



• If a call via the DISA feature is received by an extension group, this program will not work for extensions in that extension group.



- **Feature Reference**  
Section 3, Features  
Direct Inward System Access (DISA)

**[517] DISA AA Wait Time**

Selects the time that the system waits for a second digit entry. If the programmed time expires, the system will assume that the first digit is a DISA built-in auto attendant number, if a number is assigned in program [501] “DISA Built-in Auto Attendant. For example, if a number is not dialed within the programmed time after dialing 1, the system will assume that “1” is the auto attendant number.

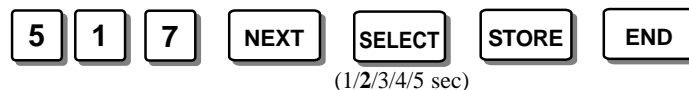

**Default** 2 seconds



- **Feature Reference**  
Section 3, Features  
Direct Inward System Access (DISA)

**[518] DISA Tone Selection after the Security Code**

Enables or disables sending a beep after entering the security code. If “Enable” is selected, a beep is sent when the number entered is the same as one of the security codes assigned in program [512] “DISA Security Codes”.

5 1 8 NEXT SELECT STORE END  
(Enable/Disable)

Default Enable



- **Feature Reference**  
Section 3, Features  
Direct Inward System Access (DISA)

**[519] DISA OGM Mute Time**

Assigns the length of time from answering a call with the DISA feature and sending the DISA outgoing message or a beep. During the assigned length of time, the system will not receive DTMF signals.

5 1 9 NEXT SELECT STORE END  
(0/2/4/6 sec)

Default 0 second



- **Feature Reference**  
Section 3, Features  
Direct Inward System Access (DISA)

### [520] UCD Group\*<sup>1</sup>

Assigns one extension group which works as the UCD group.

(1...8)

**Default** Extension group number 1



- **Feature Reference**  
Section 3, Features  
Uniform Call Distribution (UCD)

### [521] UCD Busy Waiting Time\*<sup>1</sup>

Assigns the length of time the system holds an incoming outside call via the UCD feature when all extensions in the UCD group are busy. When the programmed time expires, the call will be intercepted or disconnected according to program [523] "UCD Busy Mode".

(1...32 minutes)

**Default** 10 minutes



- **Feature Reference**  
Section 3, Features  
Uniform Call Distribution (UCD)

### [522] UCD OGM Message Interval Time\*<sup>1</sup>

Assigns interval time between sending UCD outgoing messages to an incoming outside call via the UCD feature when all extensions in the UCD group are busy. The UCD outgoing message is repeated during the time programmed in [521] "UCD Busy Waiting Time".

(30 sec/1/  
1.5/2 min)

**Default** 1 minute



- **Feature Reference**  
Section 3, Features  
Uniform Call Distribution (UCD)

\*<sup>1</sup>: Required only when the optional OGM/FAX Detection Card is installed.

**[523] UCD Busy Mode\*<sup>1</sup>**

Selects the operation when the length of time programmed in [521] “UCD Busy Waiting Time” expires. **Intercept** or **Disconnect** is available.

**Intercept:** The call will be redirected depending on programs [408]-[410] “Flexible Ringing Assignment–Day/Night/Lunch” (Intercept Routing feature). The extension which receives a redirected call rings during the length of time programmed in [526] “UCD Ringing Time after Intercept”.

**Disconnect:** The call will be disconnected immediately.



**Default** Intercept



- This program is effective only when “MODE 3” or “MODE 5” is selected in program [502] “OGM Mode Selection”. If “MODE 4” is selected, the call will be disconnected after the UCD-END outgoing message.



- **Feature References**  
Section 3, Features  
Intercept Routing, Uniform Call Distribution (UCD)

**[524] UCD Intercept Mode\*<sup>1</sup>**

Selects the operation when all extensions in the UCD group do not answer an outside call via the UCD feature within the length of time programmed in [525] “UCD Ringing Time before Intercept”. **Intercept** or **Disconnect** is available.

**Intercept:** The call is redirected depending on programs [408]-[410] “Flexible Ringing Assignment–Day/Night/Lunch” (Intercept Routing – No Answer feature).

**Disconnect:** The call is disconnected.



**Default** Intercept



- **Feature References**  
Section 3, Features  
Intercept Routing, Uniform Call Distribution (UCD)

**[525] UCD Ringing Time before Intercept\*<sup>1</sup>**

Assigns the length of time for the Intercept Routing – No Answer feature (☞ [524] “UCD Intercept Mode”, Intercept). When the time expires, the system starts to redirect the call to the programmed extension(s).

5 2 5 NEXT SELECT STORE END  
 (10/20/30/  
 40/60/120 sec)

**Default** 20 seconds



- **Feature References**  
 Section 3, Features  
 Intercept Routing, Uniform Call Distribution (UCD)

**[526] UCD Ringing Time after Intercept\*<sup>1</sup>**

Assigns the length of time to call the extension(s) where a call is redirected by the Intercept Routing – No Answer feature (☞ [524] “DISA Intercept Mode”, Intercept) after the time programmed in [525] “UCD Ringing Time before Intercept” expires.

5 2 6 NEXT SELECT STORE END  
 (10/20/30/  
 40/60/120 sec)

**Default** 20 seconds



- **Feature References**  
 Section 3, Features  
 Intercept Routing, Uniform Call Distribution (UCD)

\*<sup>1</sup>: Required only when the optional OGM/FAX Detection Card is installed.

**[600] Extension Group Assignment**

Assigns an extension group for each extension. For example: by department or floor.

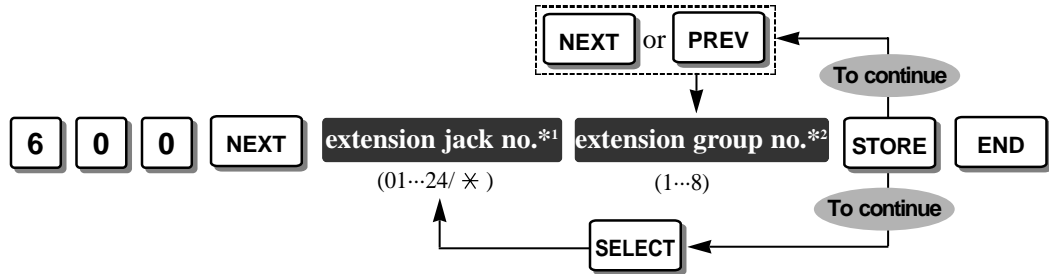

\*1 Extension jack number: 01 through 24 / \* (All extension jacks)

\*2 Extension group number: 1 through 8

**Default** All extension jacks – Extension group 1



- Every extension should belong to an extension group, but cannot belong to more than one group.



- **Feature References**  
Section 3, Features  
Extension Group, Station Hunting

**[601]-[603] TRS – Class of Service Assignment —Day/Night/Lunch**

Programs a class of service (COS) in the day, night and/or lunch modes for each extension. There are 5 class of services available for each extension.

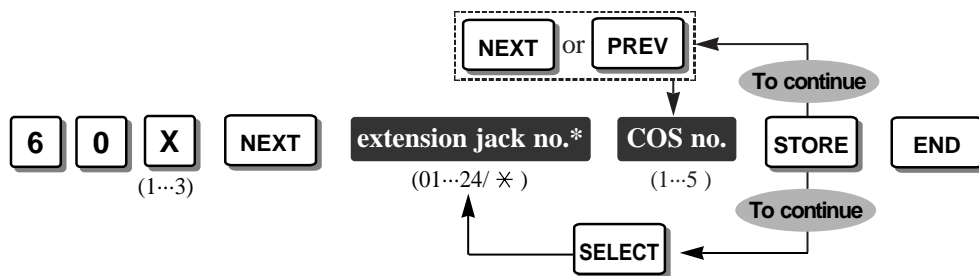

X – Program address selection number: 1 ([601] for day) / 2 ([602] for night) / 3 ([603] for lunch)

\* Extension jack number: 01 through 24 / \* (All extension jacks)

**Default** All extension jacks – COS-1



- **Feature Reference**  
Section 3, Features  
Toll Restriction

**[604] Extension Name Setting**

Assigns a name to each extension which will be displayed when making or receiving an intercom call.

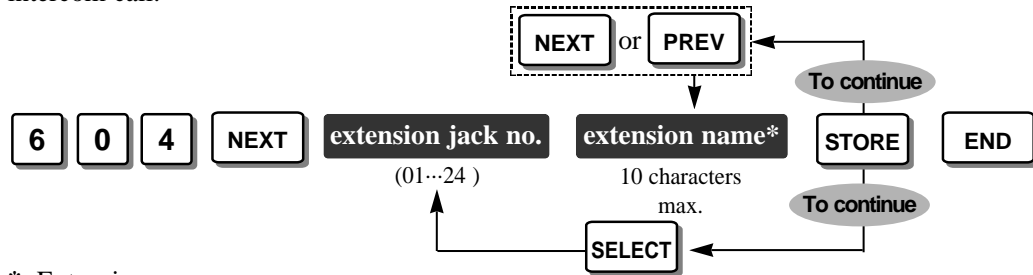

\* Extension name:  
Combination Table

| Keys \ Pressing SELECT (Times) | Pressing SELECT (Times) |    |   |   |   |   |   |  |
|--------------------------------|-------------------------|----|---|---|---|---|---|--|
|                                | 0                       | 1  | 2 | 3 | 4 | 5 | 6 |  |
| 1                              | 1                       | Q  | q | Z | z | ! | ? |  |
| 2                              | 2                       | A  | a | B | b | C | c |  |
| 3                              | 3                       | D  | d | E | e | F | f |  |
| 4                              | 4                       | G  | g | H | h | I | i |  |
| 5                              | 5                       | J  | j | K | k | L | l |  |
| 6                              | 6                       | M  | m | N | n | O | o |  |
| 7                              | 7                       | P  | p | R | r | S | s |  |
| 8                              | 8                       | T  | t | U | u | V | v |  |
| 9                              | 9                       | W  | w | X | x | Y | y |  |
| 0                              | 0                       |    | . | , | ' | : | ; |  |
| *                              | *                       | "  | + | - | = | < | > |  |
| #                              | #                       | \$ | % | & | @ | ( | ) |  |

<Example>

— To enter “Mike;

1. Press 6 and then press the SELECT button once to enter “M.”
2. Press 4 and then press the SELECT button 6 times to enter “i.”
3. Press 5 and then press the SELECT button 4 times to enter “k.”
4. Press 3 and then press the SELECT button 4 times to enter “e.”

**Default** All extension jacks – Not stored.

- ! To erase all letters, press the CLEAR button. To erase 1 letter, press .
- Each name has a maximum of 10 characters.

[605] Account Code Entry Mode

Selects the account code input mode, **Option**, **Forced**, **Verify-All** or **Verify-Toll**, for each extension jack. This feature displays the account code of the called or calling party on the SMDR.

- Option:** The user can enter any account code, if needed.
- Forced:** The user must always enter an account code. The code can be any number.
- Verify-All:** The user must always enter an assigned account code in program [310] "Account Codes" to make an outside call.
- Verify-Toll:** The user must enter an assigned account code in program [310] to make an outside call. If the user enters their extension password, they can override toll restriction and make a call with their COS number.

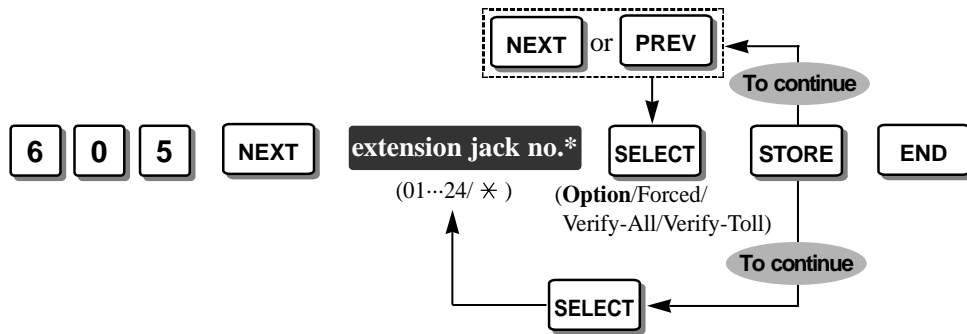

\* Extension jack number: 01 through 24 / \* (All extension jacks)

**Default** All extension jacks – Option



- **Feature References**
  - Section 3, Features
  - Account Code Entry, Toll Restriction Override by Extension Password

**[606] Call Transfer to an Outside (CO) Line**

Enables or disables transferring an intercom or outside call to any outside (CO) line manually for each extension.

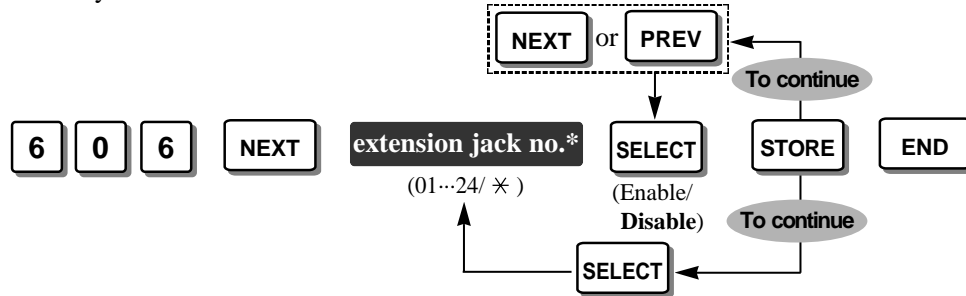

\* Extension jack number: 01 through 24 / \* (All extension jacks)

**Default** All extension jacks – Disable



• **Feature References**

Section 3, Features

Call Transfer – to Outside (CO) Line, Conference (3-party)

**[607] Call Forwarding to an Outside (CO) Line**

Enables or disables automatically forwarding an incoming intercom or outside call to any outside (CO) line for each extension.

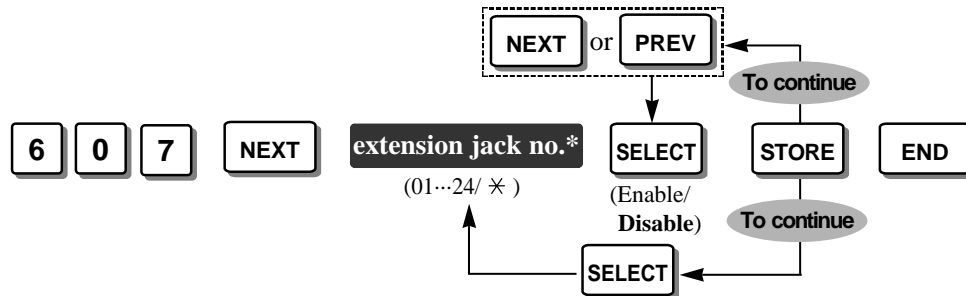

\* Extension jack number: 01 through 24 / \* (All extension jacks)

**Default** All extension jacks – Disable



• **Feature Reference**

Section 3, Features

Call Forwarding

**[608] Executive Busy Override**

Enables or disables using the Executive Busy Override feature at each extension. If enabled, an extension user can interrupt an established call.

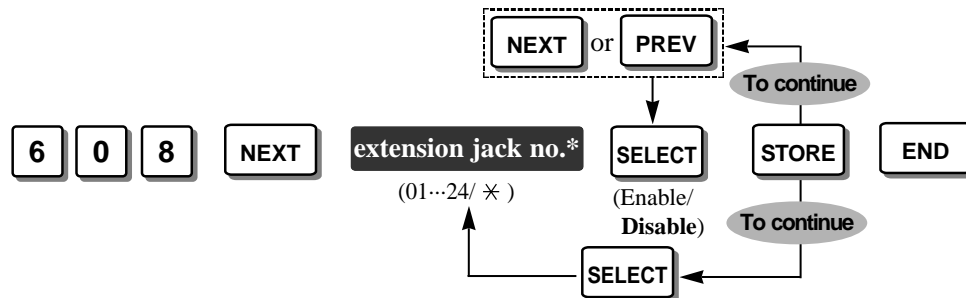

\* Extension jack number: 01 through 24 /\* (All extension jacks)

**Default** All extension jacks – Disable



- **Feature Reference**  
Section 3, Features  
Executive Busy Override

**[609] Do Not Disturb Override**

Enables or disables using the Do Not Disturb Override feature at each extension. If enabled, an extension user can ring an extension which has set the Do Not Disturb feature.

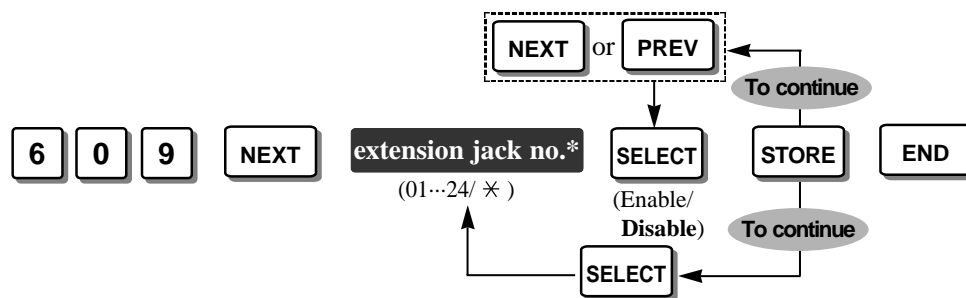

\* Extension jack number: 01 through 24 /\* (All extension jacks)

**Default** All extension jacks – Disable



- **Feature Reference**  
Section 3, Features  
Do Not Disturb (DND)

**[610] Paralleled Telephone Connection**

Enables or disables a single line telephone (SLT) to be connected in parallel with a proprietary telephone.

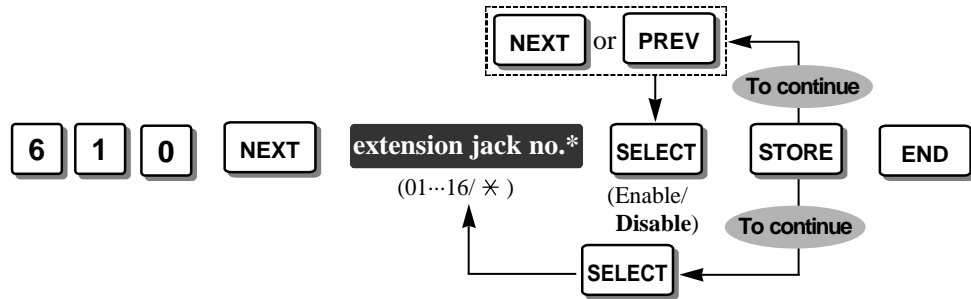

\* Extension jack number: 01 through 16 / \* (All extension jacks)

**Default** All extension jacks – Disable



- **Feature Reference**  
Section 3, Features  
Paralleled Telephone Connection

**[611] TAM (Telephone Answering Machine) Extension**

Assigns the jack number of an extension connected to a telephone answering machine (TAM) to activate the Call Retrieving from TAM feature.

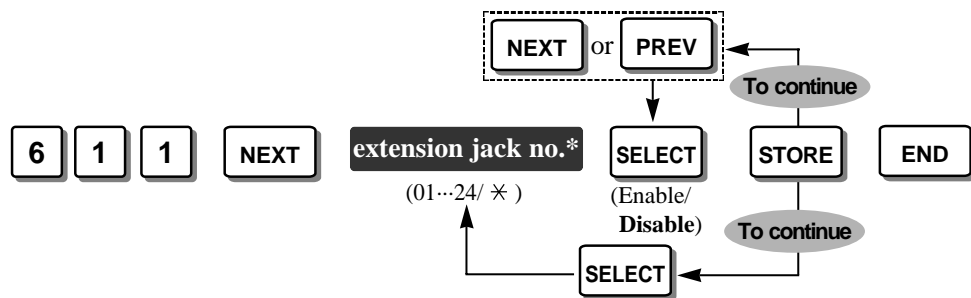

\* Extension jack number: 01 through 24 / \* (All extension jacks)

**Default** All extension jacks – Disable (not connected)



- **Feature Reference**  
Section 3, Features  
Call Pickup

**[612] Room Monitor Assignment**

Enables or disables which extension can be monitored using the Room Monitor feature.

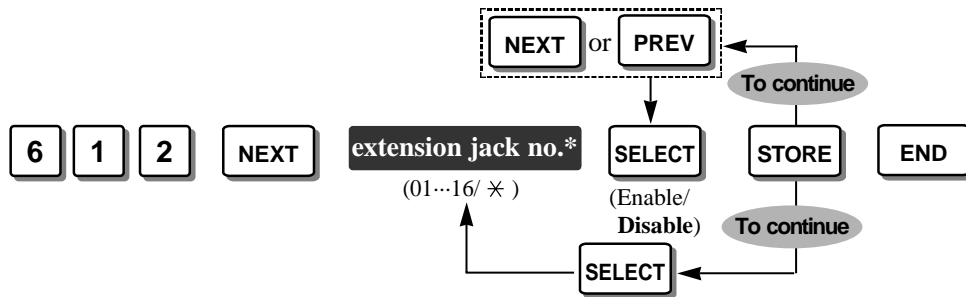

\* Extension jack number: 01 through 16 / \* (All extension jacks)

**Default** All extension jacks – Disable (Cannot be monitored.)



- **Feature Reference**  
Section 3, Features  
Room Monitor

**[613] Outside (CO) Line Duration Time Limit Selection**

Enables or disables the time limit programmed in [212] “Outside (CO) Line Duration Time Limit” for each extension.

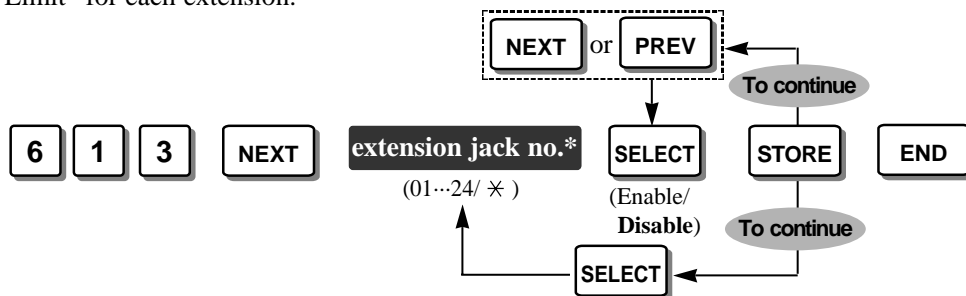

\* Extension jack number: 01 through 24 / \* (All extension jacks)

**Default** All extension jacks – Disable



- **Feature Reference**  
Section 3, Features  
Limited Call Duration

**[614] Internal Pulse Detection**

Enables or disables connecting a single line telephone (SLT) to receive pulse signals for each extension.

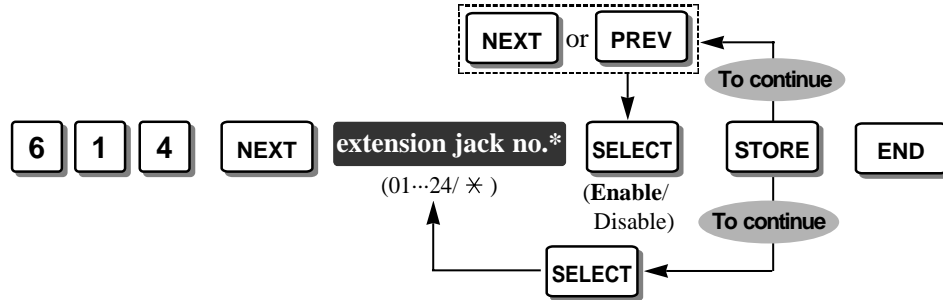

\* Extension jack number: 01 through 24 / \* (All extension jacks)

**Default** All extension jacks – Enable



- If you select “MODE 1” in program [207] “Hookswitch Flash Timing Range Selection” and “Enable” in this program, the system will distinguish between a pulse signal and hooking depending on the situation. When you select “Disable” in this program, if “1” is dialed during the pulse mode, the system will regard it as hooking and all other numbers will be disregarded.



- **Feature Reference**  
Section 3, Features  
Hookswitch Flash

**[615] LCD Language Assignment**

Selects the language, **English, Spanish, Portuguese** or **Russian**, shown on the LCD display of a proprietary telephone on an extension basis. The selected language is shown during operation and Proprietary Telephone Settings.

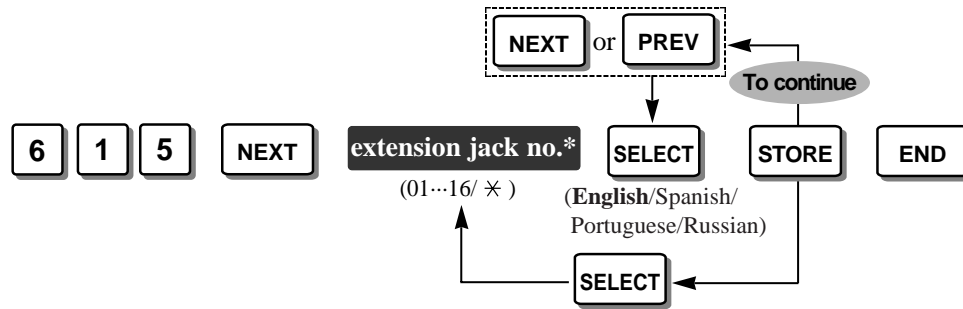

\* Extension jack number: 01 through 16 / \* (All extension jacks)

**Default**    English



- For intercom calls —  
When “Russian” is selected in this program, the calling extension’s name assigned in program [616] “Extension Name Setting in Russian” is displayed at the called extension. When another language is selected in this program, the calling extension’s name assigned in program [604] “Extension Name Setting” is displayed.
- The Russian display is only available for the KX-T7330RU.



- **Feature Reference**  
Section 3, Features  
Language Selection

**[616] Extension Name Setting in Russian**

Assigns a name to each extension in Russian which will be displayed when making or receiving an intercom call. Refer to program [604] “Extension Name Setting” for how to enter a name.

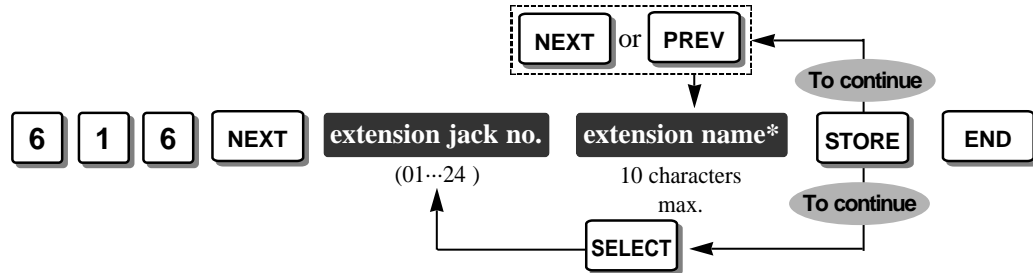

\* Extension name:  
Combination Table

| Pressing SELECT (Times)<br>Keys | 0 | 1  | 2 | 3 | 4 | 5 | 6 |
|---------------------------------|---|----|---|---|---|---|---|
| 1                               | 1 | Q  | Б | Z | Г | ! | Д |
| 2                               | 2 | A  | Ё | B | Ж | С | З |
| 3                               | 3 | D  | И | E | Й | F | Л |
| 4                               | 4 | G  | П | H | У | I | Ф |
| 5                               | 5 | J  | Ц | K | Ч | L | Ш |
| 6                               | 6 | M  | Щ | N | Ъ | O | Ы |
| 7                               | 7 | P  | Ь | R | Э | S | Ю |
| 8                               | 8 | T  | Я | U |   | V |   |
| 9                               | 9 | W  |   | X |   | Y |   |
| 0                               | 0 |    | . | , | ' | : | ; |
| *                               | * | ”  | + | - | = | < | > |
| #                               | # | \$ | % | & | @ | ( | ) |

**Default** All extension jacks – Not stored.



- The Russian display is only available for the KX-T7330RU.
- The name assigned in this program cannot be printed out by program [804] “System Data Dump”.

**[700]-[702] Doorphone Ringing Assignment — Day/Night/Lunch**

Enables or disables receiving a call from up to 4 doorphones in the day, night and/or lunch modes for each extension.

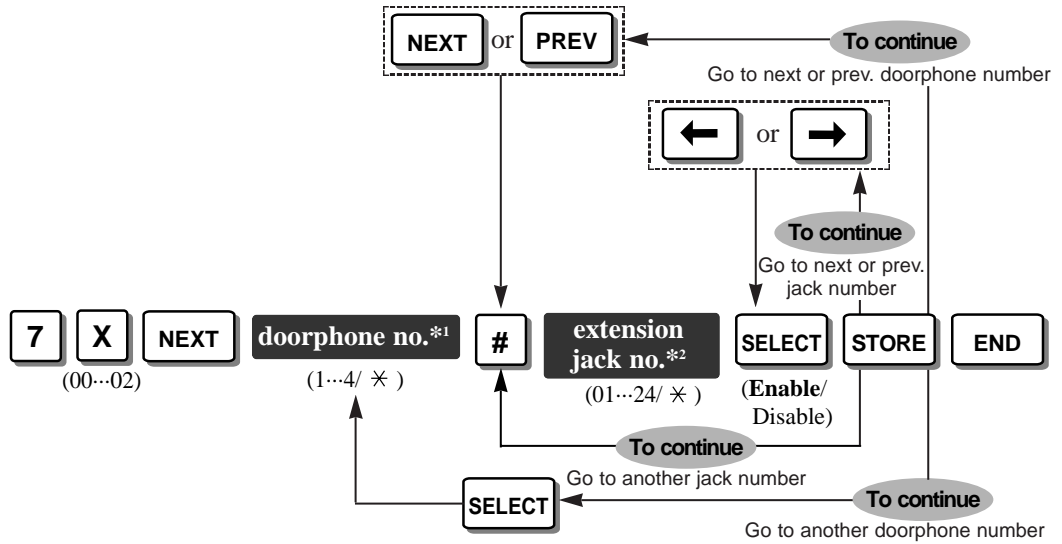

**X** – Program address selection number: 00 ([700] for day) / 01 ([701] for night) / 02 ([702] for lunch)

\*<sup>1</sup> Doorphone number: 1 through 4 / \* (All doorphones)

\*<sup>2</sup> Extension jack number: 01 through 24 / \* (All extension jacks)

**Default** All doorphones – all extension jacks – Enable



- Feature Reference  
Section 3, Features  
Doorphone Call

**[703]-[705] Door Opener Assignment — Day/Night/Lunch**

Enables or disables accessing to up to 4 door openers in the day, night and/or lunch modes for each extension.

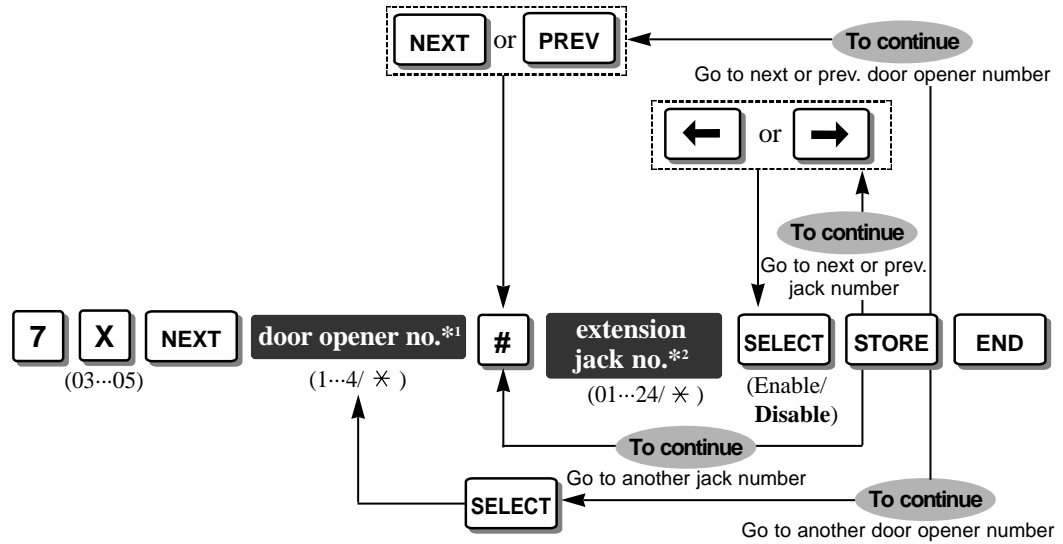

**X** – Program address selection number: 03 ([703] for day) / 04 ([704] for night) / 05 ([705] for lunch)

\*<sup>1</sup> Door opener number: 1 through 4 / \* (All door openers)

\*<sup>2</sup> Extension jack number: 01 through 24 / \* (All extension jacks)

**Default** All door openers – all extension jacks – Disable



• **Feature Reference**

Section 3, Features

Door Opener

**[706] Doorphone Ringing / Tone Pattern Selection**

Selects the doorphone ringing pattern, **Single**, **Double**, **Triple** or **S-Double**.

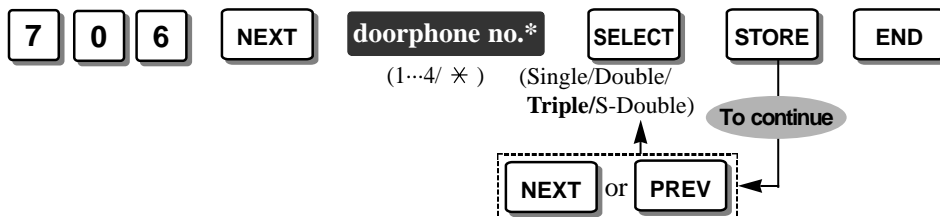
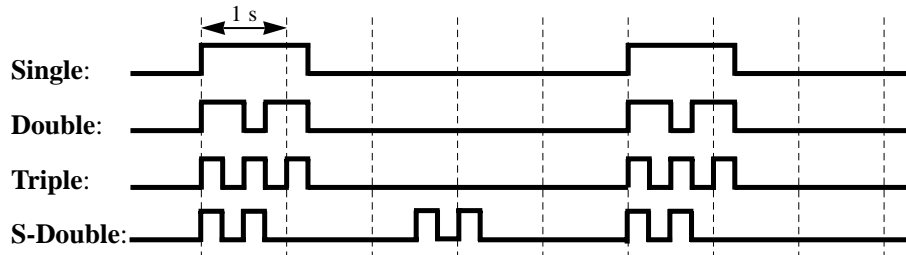

\* Doorphone number: 1 through 4 / \* (All doorphones)

**Default** All doorphones – Triple



• When a doorphone call is received at a proprietary telephone, a tone is heard instead of ringing.



- **Feature References**  
Section 3, Features  
Doorphone Call, Ringing Pattern Selection

**[707] Doorphone Access Tone Selection**

Enables or disables sending a doorphone access tone to a monitored doorphone. If enabled, the access tone is heard from the doorphone when monitoring from a telephone starts.

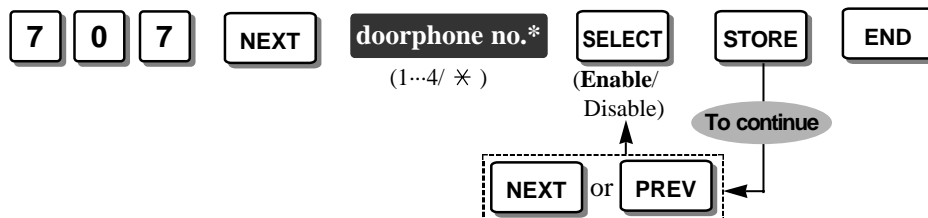

\* Doorphone number: 1 through 4 / \* (All doorphones)

**Default** All doorphones – Enable



- **Feature References**  
Section 3, Features  
Doorphone Call, Room Monitor

**[708] Doorphone Ringing Time**

Sets the ringing time when making an intercom call from a doorphone.

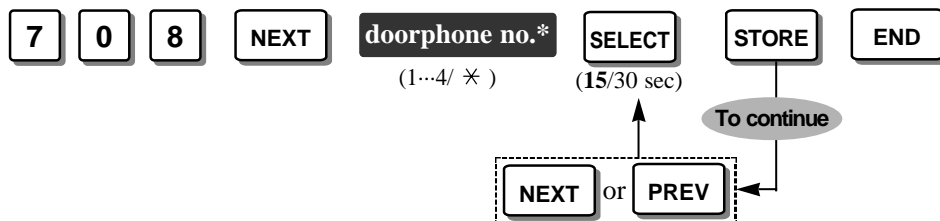

\* Doorphone number: 1 through 4 / \* (All doorphones)

**Default** All doorphones – 15 seconds



- **Feature Reference**  
Section 3, Features  
Doorphone Call

**[709] Door Opener Time**

Assigns the length of the door opener time. The door is unlocked for the assigned period of time.

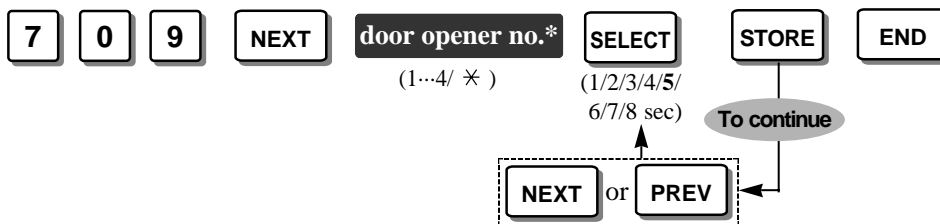

\* Door opener number: 1 through 4 / \* (All door openers)

**Default** All door openers – 5 seconds



- **Feature Reference**  
Section 3, Features  
Door Opener



**[801] SMDR Parameter**

Assigns the following 2 printing codes to match the SMDR output with the paper size used in the printer.

**Page Length:** Determines the number of lines per page.

**Skip Perf:** (Perforation) Determines the number of lines to be skipped at the end of every page.

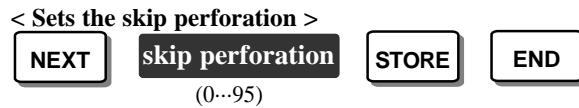
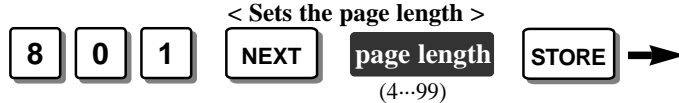

**Default** Page length – 66 lines  
Skip perforation – 0 line

- ! The page length should be at least 4 lines longer than the skip perforation length.
- To correct a wrong entry, press the CLEAR button and enter the new one.



- **Feature Reference**  
Section 3, Features  
Station Message Detail Recording (SMDR)

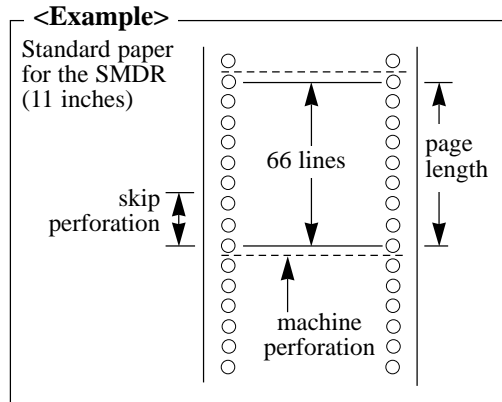

**[802] Incoming/Outgoing Call Selection for Printing**

Determines which calls will produce an SMDR printout.



\*1 Outgoing: On (Print all calls) / Off (No printing) / Toll (Print toll calls only)

\*2 Incoming: On (Print all calls) / Off (No printing)

**Default** Outgoing calls / Incoming calls – On



- If “Outgoing; Toll” is selected, only calls which are checked in programs [302]–[305] “Toll Restriction – Classes 2 through 5 Denied Codes” and are allowed, are printed out.



- **Feature Reference**  
Section 3, Features  
Station Message Detail Recording (SMDR)

**[803] Secret Speed Dialing / One-Touch Dialing Printing**

Selects to print out secret dialing numbers stored in program [001] “System Speed Dialing Entry” and/or stored in One-Touch Dialing, or not to print them out on SMDR even though secret dialing numbers are not displayed on the LCD.

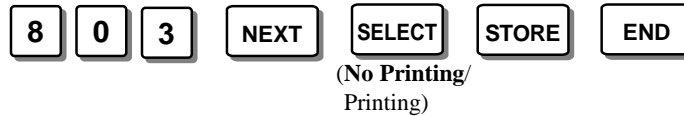

**Default**    No printing



- **Feature References**

Section 3, Features

Secret Dialing, Station Message Detail Recording (SMDR)

**[804] System Data Dump**

Starts and stops printing the assigned data. All or a specific area of current system-programmed data is printed out. The areas are as follows.

**All Para:** Prints out all data.

**System Para:** Prints out all data except for the following 4 parameters.

**CO Para:** Prints out programs [400] through [403] and [405] through [424].

**Ext Para:** If the extension is a proprietary telephone, programs [102], [516] [600] through [613] and [615] will be printed out. The assigned data on the PF (Programmable Feature) buttons and CO buttons will also be printed out. If the extension is a single line telephone, programs [102], [516] and [600] through [614] will be printed out. The assigned Personal Speed Dialing numbers are also printed out.

**DSS Para:** Prints out the assigned data in the DSS buttons and PF buttons on the DSS console.

**Speed Dial:** Prints out the System Speed Dialing numbers (00 through 99) assigned in program [001].

**Stop Output :** Stops printing.

< To select All parameters, System parameter,  
Speed dial and/or Stop output. >

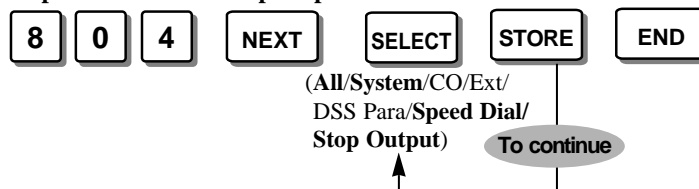

< To select the CO (outside line) parameter. >

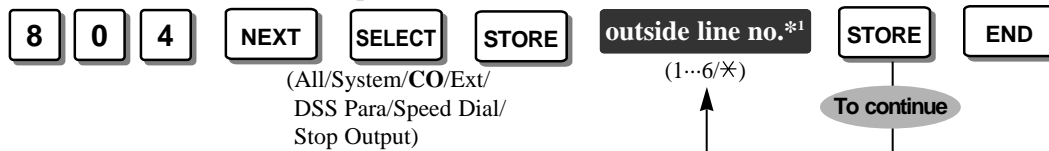

< To select the Extension parameter. >



< To select the DSS parameter. >



\*1 Outside (CO) line number: 1 through 6 / \* (All outside lines)

\*2 Extension jack number: 01 through 24 / \* (All extension jacks)

\*3 DSS console number: 1 through 2 / \* (Both DSS console numbers)



- This program and [999] “System Data Clear” are not included.



• **Feature Reference**

Section 3, Features

Station Message Detail Recording (SMDR)

**[805] SMDR Account Code Selection**

Selects printing out the account code stored in program [310] “Account Codes”, or just the index of the account code on SMDR printout.

**8** **0** **5** **NEXT** **SELECT** **STORE** **END**  
(CODE/  
INDEX)

Default CODE



- **Feature References**

Section 3, Features

Account Code Entry, Station Message Detail Recording (SMDR)

**[998] ROM Version**

Confirms the system ROM version.

**9** **9** **8** **NEXT** **END**

**Display example:**

Y501C 98XXXX (RU)  
|           |  
Version    Date

[999] System Data Clear

Resets all or a specific area of the current assigned data to the default settings. The areas are as follows.

- All Para :** Resets all data to the default settings.
- System Para:** Resets all data to the default settings except for the data of the following 4 parameters.
- CO Para:** Resets programs [400] through [403] and [405] through [424] to the default settings on an outside (CO) line basis.
- Ext Para:** Resets programs [102], [516] and [600] through [615] to the default settings on an extension basis.
- DSS Para:** Resets the assigned data on the DSS buttons and PF buttons on the DSS console.
- Speed Dial :** Resets the System Speed Dialing numbers (00 through 99) assigned in program [001].

< To select All, System parameter and/or Speed Dial. >

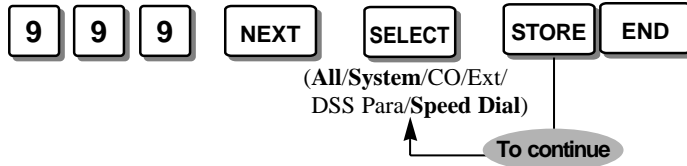

< To select the CO (outside line) parameter. >



< To select the Extension parameter. >



< To select the DSS parameter. >



- \*1 Outside (CO) line number: 1 through 6 / \* (All outside lines)
- \*2 Extension jack number: 01 through 24 / \* (All extension jacks)
- \*3 DSS console number: 1 through 2 / \* (Both DSS console numbers)



• This program and [804] “System Data Dump” are not included.

• **Feature Reference**

Section 3, Features  
System Data Default Set



*Section 5*  
*Appendix*

## 5.1 *Default Values*

| <b>Address</b> | <b>Program</b>                               | <b>Default</b>  |
|----------------|--|---|
| [000]          | Date and Time Setting                        | '98 Jan. 1 Thu 12:00 AM   |
| [001]          | System Speed Dialing Entry                   | All speed dialing numbers – Not stored  |
| [002]          | System Password                              | 1234  |
| [003]          | DSS Console Port Assignment                  | All DSS Consoles — Disable  |
| [004]          | Paired Telephone Assignment for DSS Console  | DSS1 – Disable, DSS2 – Disable  |
| [005]          | One-Touch Transfer Using a DSS Button        | With Transfer   |
| [006]          | Time (Day/Night/Lunch) Service Changing Mode | Manual  |
| [007]          | Time (Day/Night/Lunch) Service Start Time    | Every day of the week<br>— Day – 9:00 AM / Night – 5:00 PM /<br>Lunch-S – None / Lunch-E – None |
| [008]          | Operator Assignment                          | Jack-01   |
| [009]          | Extension Number Assignment                  | Jack 01 through 24 = Extn. 101 through 124  |
| [010]          | LCD Time Display Selection                   | 12 HOUR   |
| [100]          | Hunting Group Set                            | All extension groups — Disable  |
| [101]          | Hunting Type                                 | All extension groups – Terminate  |
| [102]          | Voice Mail Part                              | All extension jacks — Disable   |
| [103]          | DTMF Integration                             | Disable   |
| [104]          | Hold Mode Selection                          | Hold-1  |
| [105]          | Conference Tone                              | Enable  |
| [106]          | External Paging Access Tone                  | Enable  |
| [107]          | DTMF Receiver Check                          | All DTMF receivers — Enable   |
| [108]          | Flash Mode for a Station Locked Extension    | Disable   |
| [109]          | CO Indicator Assignment                      | Enable  |
| [110]          | Flash Key Mode                               | MODE 1  |
| [111]          | Hold Music Selection                         | Internal  |
| [112]          | DSS Console Indication Mode                  | Enable  |
| [113]          | Automatic Redial Repeat                      | 10 times  |
| [114]          | Automatic Redial Interval Time               | 60 seconds  |
| [115]          | Extension Ringing Pattern Selection          | Double  |
| [116]          | Conference Pattern Selection                 | 5-party C-2 E-5   |

## 5.1 *Default Values*

| Address     | Program  | Default                |
|-------------|--|------------------------|
| [117]       | Call Pickup Tone                                       | Enable                 |
| [118]       | Pulse Restriction                                      | Enable                 |
| [119]       | Redialing after Pulse to Tone Conversion               | Disable                |
| [120]       | Bell Frequency   | 25 Hz                  |
| [121]       | Automatic Outside (CO) Line Access Number Selection    | 9                      |
| [122]       | Automatic Rotation for Outside (CO) Line Access        | Disable                |
| [123]       | Break Ratio  | MODE 2                 |
| [124]       | SLT Ringing Mode Selection                             | MODE 1                 |
| [125]       | Toll Restriction Check for * and #                     | Enable                 |
| [200]       | Hold Recall Time                                       | 30 seconds             |
| [201]       | Transfer Recall Time                                   | 30 seconds             |
| [202]       | Call Forwarding Start Time                             | 15 seconds delay       |
| [203]       | Pickup Dial Delay Time                                 | 3 seconds              |
| [204]       | Call Duration Count Start Time                         | 10 seconds after dial  |
| [205]       | Outside-to-Outside (CO-to-CO) Line Duration Time Limit | 10 minutes             |
| [206]       | Dialing Start Time                                     | 0 millisecond          |
| [207]       | Hookswitch Flash Timing Range Selection                | MODE 4                 |
| [208]       | Interdigit Time  | 10 seconds             |
| [210]       | DTMF Time  | MODE 1                 |
| [211]       | No Dial Disconnection                                  | Disable                |
| [212]       | Outside (CO) Line Duration Time Limit                  | 10 minutes             |
| [213]       | Bell Off Detection                                     | 6 seconds              |
| [300]       | Carrier Code Assignment                                | All codes – Not stored |
| [301]       | Toll Restriction — System Speed Dialing Boundary Class | Boundary Class-1       |
| [302]–[305] | Toll Restriction — Classes 2 through 5 Denied Codes    | All codes – Not stored |
| [306]       | Toll Restriction — Exception Codes                     | All codes – Not stored |
| [309]       | Emergency Dial Number Set                              | All codes – Not stored |
| [310]       | Account Codes  | All codes – Not stored |

## 5.1 *Default Values*

| Address     | Program   | Default   |
|-------------|---|---|
| [311]       | Automatic Pause Insertion Codes                       | All codes – Not stored  |
| [312]       | Toll Restriction — Station Lock Boundary Class        | Disable   |
| [400]       | Outside (CO) Line Connection Assignment               | All outside (CO) lines – Connect  |
| [401]       | Dial Mode   | All outside (CO) lines — Pulse Mode   |
| [402]       | Pulse Speed Selection                                 | All outside (CO) lines – Low Speed  |
| [403]       | Host PBX Access Codes                                 | All outside (CO) lines – Not stored   |
| [404]       | Outside (CO) Line Group Assignment                    | CO1 — TRK GRP-1; CO2 — TRK GRP-2; CO3 — TRK GRP-3; CO4 — TRK GRP-4; CO5 — TRK GRP-5; CO6 — TRK GRP-6; |
| [405]–[407] | Flexible Outward Dialing Assignment — Day/Night/Lunch | All outside (CO) lines – all extension jacks – Enable — Day/Night/Lunch                               |
| [408]–[410] | Flexible Ringing Assignment — Day/Night/Lunch         | All outside (CO) lines – all extension jacks – Enable — Day/Night/Lunch                               |
| [411]–[413] | Delayed Ringing Assignment — Day/Night/Lunch          | All outside (CO) lines – all extension jacks – Immdtly — Day/Night/Lunch                              |
| [414]–[416] | Outside (CO) Line Mode — Day/Night/Lunch              | All outside (CO) lines — Normal — Day/Night/Lunch   |
| [417]       | Pause Time  | All outside (CO) lines — 1.5 seconds  |
| [418]       | Flash Time  | All outside (CO) lines – 600 milliseconds   |
| [419]       | Automatic Designated Outside (CO) Line Access         | All outside (CO) lines — Enable   |
| [420]       | Calling Party Control (CPC) Signal                    | All outside (CO) lines – 42 (350 milliseconds)  |
| [421]       | CPC Detection for Outgoing Calls                      | All outside (CO) lines – Disable  |
| [422]       | Disconnect Time                                       | All outside (CO) lines – 1.5 seconds  |
| [423]       | Outside (CO) Line Ringing Pattern Selection           | All outside (CO) lines – Single   |
| [424]       | Reverse (Polarity) Circuit Assignment                 | All outside (CO) lines – Disable  |
| [500]       | DISA Incoming Dialing Mode Selection                  | Without AA  |
| [501]       | DISA Built-in Auto Attendant                          | All numbers — Not Stored  |
| [502]       | OGM Mode Selection                                    | MODE 1  |
| [503]       | FAX Connection  | Disable   |
| [504]       | DISA Delayed Answer Time                              | 3 seconds   |
| [505]       | DISA Waiting Time after OGM                           | 5 seconds   |
| [506]       | DISA Busy Mode  | Disconnect  |

## 5.1 *Default Values*

| Address     | Program  | Default  |
|-------------|--|--|
| [507]       | DISA Intercept Mode                                    | Intercept  |
| [508]       | DISA Ringing Time before Intercept                     | 20 seconds   |
| [509]       | DISA Ringing Time after Intercept                      | 20 seconds   |
| [510]       | DISA No Dial Mode                                      | DISA1 and DISA2 — Intercept  |
| [511]       | DISA Security Type                                     | Trunk Security   |
| [512]       | DISA Security Codes                                    | CODE-01 = 0000 / CODE-02 = 0000<br>CODE-03 = 0000 / CODE-04 = 0000 |
| [513]       | Cyclic Tone Detection                                  | 4 Times  |
| [514]       | Fax Tone Detection                                     | 1 Time   |
| [515]       | Intercept Time for Internal DISA                       | 3 seconds  |
| [516]       | DISA Incoming Assignment                               | All extension jacks — Enable                                       |
| [517]       | DISA AA Wait Time                                      | 2 seconds  |
| [518]       | DISA Tone Selection after the Security Code            | Enable   |
| [519]       | DISA OGM Mute Time                                     | 0 second   |
| [520]       | UCD Group  | Group – 1  |
| [521]       | UCD Busy Waiting Time                                  | 10 minutes   |
| [522]       | UCD OGM Message Interval Time                          | 1 minute   |
| [523]       | UCD Busy Mode  | Intercept  |
| [524]       | UCD Intercept Mode                                     | Intercept  |
| [525]       | UCD Ringing Time Before Intercept                      | 20 seconds   |
| [526]       | UCD Ringing Time After Intercept                       | 20 seconds   |
| [600]       | Extension Group Assignment                             | All extension jacks — EXT GRP-1                                    |
| [601]–[603] | TRS – Class of Service Assignment<br>— Day/Night/Lunch | All extension jacks — COS-1  |
| [604]       | Extension Name Setting                                 | All extension jacks – Not stored                                   |
| [605]       | Account Code Entry Mode                                | All extension jacks – Option                                       |
| [606]       | Call Transfer to an Outside (CO) Line                  | All extension jacks – Disable                                      |
| [607]       | Call Forwarding to an Outside (CO) Line                | All extension jacks – Disable                                      |
| [608]       | Executive Busy Override                                | All extension jacks – Disable                                      |
| [609]       | Do Not Disturb Override                                | All extension jacks – Disable                                      |
| [610]       | Paralleled Telephone Connection                        | All extension jacks – Disable                                      |

## 5.1 *Default Values*

---

| Address     | Program   | Default   |
|-------------|---|---|
| [611]       | TAM (Telephone Answering Machine) Extension     | All extension jacks – Disable   |
| [612]       | Room Monitor Assignment                         | All extension jacks – Disable   |
| [613]       | Outside (CO) Line Duration Time Limit Selection | All extension jacks – Disable   |
| [614]       | Internal Pulse Detection                        | All extension jacks – Enable  |
| [615]       | LCD Language Assignment                         | English   |
| [616]       | Extension Name Setting in Russian               | All extension jacks – Not stored  |
| [700]–[702] | Doorphone Ringing Assignment — Day/Night/Lunch  | All doorphones — all extension jacks – Enable — Day/Night/Lunch                           |
| [703]–[705] | Door Opener Assignment — Day/Night/Lunch        | All door openers – all extension jacks – Disable  |
| [706]       | Doorphone Ringing/Tone Pattern Selection        | All doorphones — Triple   |
| [707]       | Doorphone Access Tone Selection                 | All doorphones — Enable   |
| [708]       | Doorphone Ringing Time                          | All doorphones — 15 seconds   |
| [709]       | Door Opener Time                                | All door openers — 5 seconds  |
| [800]       | SMDR RS-232C Communication Parameters           | New line code = CR+LF; Baud rate = 9600; Word length = 8; Parity bit = Mark; Stop bit = 1 |
| [801]       | SMDR Parameter                                  | Page length – 66; Skip perforation – 0  |
| [802]       | Incoming/Outgoing Call Selection for Printing   | Outgoing calls – On; Incoming calls – On  |
| [803]       | Secret Speed Dialing/One Touch Dialing Printing | No printing   |
| [805]       | SMDR Account Code Selection                     | CODE  |

## 5.2 Specifications

|  |  |   |
|--|--|---|
| System Capacity                                | KX-TA308   | Outside (CO) Lines: 3 max. (6 max. with 3-CO Line & 8 Ext Expansion Card)<br>Extensions : 8 max. (24 max. with 3-CO Line & 8 Ext Expansion Card and 8 SLT Extension Expansion Card) |
|  | KX-TA616   | Outside (CO) Lines: 6 max.<br>Extensions : 16 max. (24 max. with 8 SLT Extension Expansion Card)  |
| Control Method                                 | CPU: 16 bit CPU<br>Control ROM: 4 MB, Control RAM: 512 KB  |   |
| Switching                                      | Space Division CMOS Crosspoint Switch  |   |
| Power Supplies                                 | Primary: 110 – 240 VAC, 50/60 Hz (1.0 – 0.5 A)<br>Secondary: Circuit Volt (+5V, +26V)  |   |
| Dialing  | Dial Pulse (DP):10 pps, 20pps<br>Tone (DTMF) Dialing, DTMF–DP  |   |
| Intercom Paths                                 | 4  |   |
| Connector                                      | Outside (CO) Lines : 2-pin Modular Connector (RJ11)<br>Extensions/Doorphone: 4-pin Modular Connector<br>Pager/Music Source : EIAJ RC-6701 A plug (two-conductor, ø 3.5 mm in diameter)                                   |   |
| Extension Connection Cable                     | KX-T7320 / KX-T7330 / KX-T7350 /<br>KX-T7020 / KX-T7030 / KX-T7033 /<br>KX-T7050 / KX-T7055 / KX-T7130 . . . . . 2 pair wire (T, R, H, L)<br>Single Line Telephones . . . . . 1 pair wire (T, R)                         |   |
| SMDR (Station Message Detail Recording)        | Interface : Serial Interface (RS-232C) (D-SUB, 9-pin)<br>Output Equipment: Printer<br>Detail Recording : Date, Time, Extension Number, Outside (CO) Line Number, Dialed Number, Call Duration, Account Code              |   |
| Station Loop Limit                             | KX-T7320 / KX-T7330 / KX-T7350 /<br>KX-T7020 / KX-T7030 / KX-T7033 /<br>KX-T7050 / KX-T7055 / KX-T7130 . . . . . 40 ohms<br>Single Line Telephones . . . . . 600 ohms including set<br>Doorphones . . . . . 20 ohms      |   |
| Minimum Leakage Resistance                     | 15,000 ohms  |   |
| Maximum Number of Station Instruments per Line | 1 for a KX-T7320 / KX-T7330 / KX-T7350 / KX-T7020 / KX-T7030 / KX-T7033 / KX-T7050 / KX-T7055 / KX-T7130 or single line telephone<br>2 for by parallel connection of a proprietary telephone and a single line telephone |   |
| Ring Voltage                                   | 80 Vrms at 25 Hz depending on the Ringing Load   |   |
| Central Office Loop Limit                      | 1,600 ohms max.  |   |
| Environmental Requirements                     | 0 – 40 °C, 10 – 90% relative humidity  |   |
| Hookswitch Flash Timing Range                  | 80 – 1,000 milliseconds  |   |

## 5.2 Specifications

---

### *Lines, Cards, Station Equipment*

| <b>Item</b>                        | <b>Max. Quantity</b> |
|------------------------------------|----------------------|
| Service Units                      | 1                    |
| Outside (CO) lines                 | 6                    |
| Extension Jacks                    | 24                   |
| Station Terminals                  | 40                   |
| 3-CO Line and 8 Ext Expansion Card | 1 (KX-TA308 only)    |
| 8 SLT Extension Expansion Card     | 1                    |
| OGM/FAX Detection Card             | 1                    |
| Doorphone/Door Opener Card         | 1                    |
| Doorphones                         | 4                    |
| Door Openers                       | 4                    |
| External Pager                     | 1                    |
| External Music Source              | 1                    |
| DSS Consoles                       | 2                    |

### *System Data*

| <b>Item</b>              | <b>Max. Quantity</b>                        |
|--------------------------|---|
| Operator                 | 1   |
| System Speed Dialing     | 100   |
| One Touch Dialing        | 24 per extension<br>(Proprietary telephone) |
| Personal Speed Dialing   | 10 per extension                            |
| Call Park areas          | 10  |
| Absent Messages          | 6   |
| Toll Restriction Classes | 5   |
| Extension Groups         | 8   |
| Message Waitings         | 8 per extension                             |

*Section 6*  
*TroubleShooting*

## 6.1 *While Installing*

| PROBLEM   | PROBABLE CAUSE   | POSSIBLE SOLUTION   |
|---|--|---|
| Extension does not operate.   | <p>Something is wrong with the printed circuit board (Extension Card).</p> <p>Something is wrong with the connection between the system and extension.</p> <p>A telephone with an A-A1 relay is connected.</p> <p>Something is wrong with the extension.</p> | <p>Exchange the printed circuit board with another printed circuit board.</p> <p>Take the extension and plug it into the same extension port using a short telephone cord. If the telephone does not work, the connection between the system and the extension must be repaired.</p> <p>Use a 2 wire cord.<br/>Set the A-A1 relay switch on the telephone to the “OUT” or “OFF” position.</p> <p>Take the extension and plug it into another extension port that is working. If the telephone does not work, replace the phone.</p> |
| Improper reset operation.   |  | Turn the Power Switch “OFF” and then “ON”.  |
| Noise during external paging.   | Induced noise on the wire between the system and the amplifier.  | Use a shielded cable as the connection wire between the system and amplifier. A short shielded cable is recommended.  |
| Volume distortion from external music source.   | Excessive input level from external music source.  | Decrease the output level of the external music source by using the volume control on the music source.   |
| Speed Dialing or One-Touch Dialing does not function.   | Wrong programming.   | Enter an outside line access number (9 or 0, 81 through 86) in programming.   |
| A proprietary telephone connected to extension jacks 01 through 08 or 09 through 16 does not operate, but a single line telephone operates. | An extension (H, L) jack 01 through 08 or 09 through 16 may have been shorted.   | Turn the Power Switch “OFF”.<br>Fix the shorted part, then turn the Power Switch “ON”.  |

## 6.2 While Connecting

Connection between the system and a proprietary telephone:

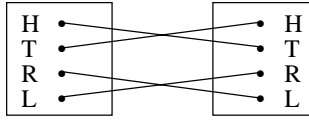
| CAUSE   |  | SOLUTION  |
|---|--|---|
| T/R is connected to H/L.<br><br>KX-TA308 or<br>KX-TA616      Extension |  | Use the correct cord (the inner 2 wires are for T/R and the outer 2 wires are for H/L). |

Connection between the system and a single line telephone:

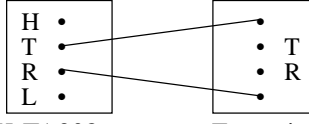
| CAUSE   |  | SOLUTION  |
|---|--|---|
| T/R is connected to H/L.<br><br>KX-TA308 or<br>KX-TA616      Extension |  | Use the correct cord (the inner 2 wires are for T/R). |

Connection between the system and a single line telephone that is polarity-sensitive:

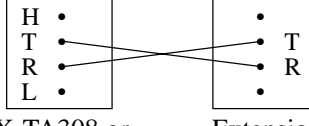
| CAUSE   |  | SOLUTION                        |
|---|--|---------------------------------|
| "T" is connected to "R".<br><br>KX-TA308 or<br>KX-TA616      Extension |  | Reverse the connections of T/R. |

Connection between the Central Office and the system:

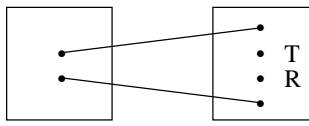
| CAUSE   |  | SOLUTION  |
|---|--|---|
| Outside lines are connected to H/L.<br><br>Outside line      KX-TA308 or<br>KX-TA616 |  | Reconnect the outside (CO) lines to T/R using 2-conductor wiring. |

Can you dial an extension?

No

Yes

Can you dial out using an outside (CO) line?

No

## 6.3 While Operating

| PROBLEM   | PROBABLE CAUSE   | POSSIBLE SOLUTION   |
|---|--|---|
| When using the speakerphone with a proprietary telephone, KX-T7030, KX-T7130, KX-T7330 or KX-T7033, nothing is heard. | The HANDSET/HEADSET selector on the KX-T7030, KX-T7130, KX-T7330 or KX-T7033 is set to the "HEADSET" position. | When the headset is not used, set the HANDSET/HEADSET selector to the "HANDSET" position.   |
| The unit does not ring.   | The Ringer Volume Selector is set to "OFF".  | Set to "HIGH" or "LOW".   |
| During a power failure, the extension connected to jack number 01 or 09 does not operate.                             | A proprietary telephone is connected to the jack.  | Disconnect the proprietary telephone and connect a single line telephone.   |
| Making an outside call cannot be performed.   | The corresponding CO button does not exist on the proprietary telephone.                                       | Program the CO button. See the Flexible Button Assignment. (☞ Operating Instructions, 1.2 Proprietary Telephone Settings, "Customizing the Buttons on Your Telephone")  |
| A tone type single line telephone (SLT) user cannot make a call.  | There may be something wrong with a DTMF receiver.   | <ol style="list-style-type: none"> <li>1. Select "Enable" for DTMF receiver 1 and "Disable" for DTMF receiver 2 in program [107].</li> <li>2. Make a call using a tone type SLT connected to one of extension jacks 01–08.</li> <li>3. If you cannot make the call, the problem may have been caused by DTMF receiver 1. If the call can be made, go to step 4.</li> <li>4. Try DTMF receiver 2. Select "Disable" for DTMF receiver 1 and "Enable" for DTMF receiver 2 in program [107], and make another call. If you cannot make the call, the problem may have been caused by DTMF receiver 2. If the call can be made, go to step 5.</li> <li>5. Check the other 4 DTMF receivers in the same way. Refer to program [107].</li> </ol> |

*Section 7*  
*Programming Tables*

# 7 Programming Tables

| [000] Date and Time Setting |                   |                        |                 |                                |                  |                     |         |
|-----------------------------|-------------------|------------------------|-----------------|--------------------------------|------------------|---------------------|---------|
|                             | Year<br>(00 – 99) | Month<br>(Jan. – Dec.) | Day<br>(1 – 31) | Day of the week<br>(Sun – Sat) | Hour<br>(1 – 12) | Minute<br>(00 – 59) | AM / PM |
| Default                     | '98               | Jan.                   | 1               | Thu                            | 12               | 00                  | AM      |
| Change                      |                   |                        |                 |                                |                  |                     |         |

| [002] System Password |   |   |   |                            |
|-----------------------|---|---|---|----------------------------|
| Default               |   |   |   | Parameter: 4 digits, 0 – 9 |
| 1                     | 2 | 3 | 4 |                            |

|           | [003]<br>DSS Console Port Assignment     | [004]<br>Paired Telephone Assignment for DSS Console |
|-----------|--|--|
| Selection | DSS console jack no. (02...16) / Disable | Paired telephone jack no. (01...16) / Disable        |
| Default   | All: Disable                             | DSS 1 – Disable / DSS 2 – Disable                    |
| DSS 1     |  |  |
| DSS 2     |  |  |

| [005] One-Touch Transfer Using a DSS Button |         |           |
|---|---------|-----------|
|   | Default | Selection |
| With Transfer                               | ✓       |           |
| Without Transfer                            |         |           |

| [006] Time (Day/Night/Lunch) Service Changing Mode |         |           |
|--|---------|-----------|
|  | Default | Selection |
| Manually   | ✓       |           |
| Automatically                                      |         |           |

| [007] Time (Day/Night/Lunch) Service Start Time |           |           |      |      |      |      |      |      |      |
|---|-----------|-----------|------|------|------|------|------|------|------|
|   | Default   | Change    |      |      |      |      |      |      |      |
|   | Every day | Every day | Sun. | Mon. | Tue. | Wed. | Thu. | Fri. | Sat. |
| Day   | 9:00 AM   |           |      |      |      |      |      |      |      |
| Night   | 5:00 PM   |           |      |      |      |      |      |      |      |
| Lunch-S   | None      |           |      |      |      |      |      |      |      |
| Lunch-E   | None      |           |      |      |      |      |      |      |      |

| [008] Operator Assignment |         |          |
|---------------------------|---------|----------|
|                           | Default | Jack no. |
| Operator                  | Jack-01 |          |

| [010] LCD Time Display Selection |         |           |
|----------------------------------|---------|-----------|
|                                  | Default | Selection |
| 12 HOUR                          | ✓       |           |
| 24 HOUR                          |         |           |

# 7 *Programming Tables*

| <b>[001] System Speed Dialing Entry</b> |                                   |         |                                   |
|---|-----------------------------------|---------|-----------------------------------|
| SPD no.                                 | Telephone number (32 digits max.) | SPD no. | Telephone number (32 digits max.) |
| Default                                 | All: Not stored                   |         |                                   |
| 00                                      |                                   | 40      |                                   |
| 01                                      |                                   | 41      |                                   |
| 02                                      |                                   | 42      |                                   |
| 03                                      |                                   | 43      |                                   |
| 04                                      |                                   | 44      |                                   |
| 05                                      |                                   | 45      |                                   |
| 06                                      |                                   | 46      |                                   |
| 07                                      |                                   | 47      |                                   |
| 08                                      |                                   | 48      |                                   |
| 09                                      |                                   | 49      |                                   |
| 10                                      |                                   | 50      |                                   |
| 11                                      |                                   | 51      |                                   |
| 12                                      |                                   | 52      |                                   |
| 13                                      |                                   | 53      |                                   |
| 14                                      |                                   | 54      |                                   |
| 15                                      |                                   | 55      |                                   |
| 16                                      |                                   | 56      |                                   |
| 17                                      |                                   | 57      |                                   |
| 18                                      |                                   | 58      |                                   |
| 19                                      |                                   | 59      |                                   |
| 20                                      |                                   | 60      |                                   |
| 21                                      |                                   | 61      |                                   |
| 22                                      |                                   | 62      |                                   |
| 23                                      |                                   | 63      |                                   |
| 24                                      |                                   | 64      |                                   |
| 25                                      |                                   | 65      |                                   |
| 26                                      |                                   | 66      |                                   |
| 27                                      |                                   | 67      |                                   |
| 28                                      |                                   | 68      |                                   |
| 29                                      |                                   | 69      |                                   |
| 30                                      |                                   | 70      |                                   |
| 31                                      |                                   | 71      |                                   |
| 32                                      |                                   | 72      |                                   |
| 33                                      |                                   | 73      |                                   |
| 34                                      |                                   | 74      |                                   |
| 35                                      |                                   | 75      |                                   |
| 36                                      |                                   | 76      |                                   |
| 37                                      |                                   | 77      |                                   |
| 38                                      |                                   | 78      |                                   |
| 39                                      |                                   | 79      |                                   |

# 7 *Programming Tables*

| <b>(Continued)</b> |                                |         |                                |
|--------------------|--------------------------------|---------|--------------------------------|
| SPD no.            | Telephone no. (32 digits max.) | SPD no. | Telephone no. (32 digits max.) |
| 80                 |                                | 90      |                                |
| 81                 |                                | 91      |                                |
| 82                 |                                | 92      |                                |
| 83                 |                                | 93      |                                |
| 84                 |                                | 94      |                                |
| 85                 |                                | 95      |                                |
| 86                 |                                | 96      |                                |
| 87                 |                                | 97      |                                |
| 88                 |                                | 98      |                                |
| 89                 |                                | 99      |                                |

| Extension jack no. | <b>[009] Extension Number Assignment</b> |                        | <b>[600] Extension Group Assignment</b> |   |   |   |   |   |   |                           | <b>[604] Extension Name Setting</b> | <b>[616] Extension Name Setting in Russian</b> |
|--------------------|--|------------------------|---|---|---|---|---|---|---|---------------------------|-------------------------------------|--|
|                    | Extension no. (100...199)                |                        | Extension group no. (1...8)             |   |   |   |   |   |   |                           | Extension name (10 character max.)  | Extension name (10 character max.)             |
| Default            | Change                                   | Default: All – Group 1 |   |   |   |   |   |   |   | Default: All – Not stored |                                     |  |
|                    |  |                        | 1                                       | 2 | 3 | 4 | 5 | 6 | 7 | 8                         |                                     |  |
| 01                 | 101                                      |                        |   |   |   |   |   |   |   |                           |                                     |  |
| 02                 | 102                                      |                        |   |   |   |   |   |   |   |                           |                                     |  |
| 03                 | 103                                      |                        |   |   |   |   |   |   |   |                           |                                     |  |
| 04                 | 104                                      |                        |   |   |   |   |   |   |   |                           |                                     |  |
| 05                 | 105                                      |                        |   |   |   |   |   |   |   |                           |                                     |  |
| 06                 | 106                                      |                        |   |   |   |   |   |   |   |                           |                                     |  |
| 07                 | 107                                      |                        |   |   |   |   |   |   |   |                           |                                     |  |
| 08                 | 108                                      |                        |   |   |   |   |   |   |   |                           |                                     |  |
| 09                 | 109                                      |                        |   |   |   |   |   |   |   |                           |                                     |  |
| 10                 | 110                                      |                        |   |   |   |   |   |   |   |                           |                                     |  |
| 11                 | 111                                      |                        |   |   |   |   |   |   |   |                           |                                     |  |
| 12                 | 112                                      |                        |   |   |   |   |   |   |   |                           |                                     |  |
| 13                 | 113                                      |                        |   |   |   |   |   |   |   |                           |                                     |  |
| 14                 | 114                                      |                        |   |   |   |   |   |   |   |                           |                                     |  |
| 15                 | 115                                      |                        |   |   |   |   |   |   |   |                           |                                     |  |
| 16                 | 116                                      |                        |   |   |   |   |   |   |   |                           |                                     |  |
| 17                 | 117                                      |                        |   |   |   |   |   |   |   |                           |                                     |  |
| 18                 | 118                                      |                        |   |   |   |   |   |   |   |                           |                                     |  |
| 19                 | 119                                      |                        |   |   |   |   |   |   |   |                           |                                     |  |
| 20                 | 120                                      |                        |   |   |   |   |   |   |   |                           |                                     |  |
| 21                 | 121                                      |                        |   |   |   |   |   |   |   |                           |                                     |  |
| 22                 | 122                                      |                        |   |   |   |   |   |   |   |                           |                                     |  |
| 23                 | 123                                      |                        |   |   |   |   |   |   |   |                           |                                     |  |
| 24                 | 124                                      |                        |   |   |   |   |   |   |   |                           |                                     |  |
| *                  |  |                        |   |   |   |   |   |   |   |                           |                                     |  |

# 7 Programming Tables

| [100] Hunting Group Set |         |                                     |   |   |   |   |   |   |   |   |
|-------------------------|---------|-------------------------------------|---|---|---|---|---|---|---|---|
| Selection               | Default | Extension group no. (1...8, *: all) |   |   |   |   |   |   |   |   |
|                         | All     | 1                                   | 2 | 3 | 4 | 5 | 6 | 7 | 8 | * |
| Disable                 | ✓       |                                     |   |   |   |   |   |   |   |   |
| Enable                  |         |                                     |   |   |   |   |   |   |   |   |

| [101] Hunting Type |         |                                     |   |   |   |   |   |   |   |   |
|--------------------|---------|-------------------------------------|---|---|---|---|---|---|---|---|
| Selection          | Default | Extension group no. (1...8, *: all) |   |   |   |   |   |   |   |   |
|                    | All     | 1                                   | 2 | 3 | 4 | 5 | 6 | 7 | 8 | * |
| Terminate          | ✓       |                                     |   |   |   |   |   |   |   |   |
| Circular           |         |                                     |   |   |   |   |   |   |   |   |

|         | [102] Voice Mail Port |   |    |    |    |   | [107] DTMF Receiver Check |                           |   |   |   |   |   |  |
|---------|-----------------------|---|----|----|----|---|---------------------------|---------------------------|---|---|---|---|---|--|
|         | Default               | Extn. jack no. (07, 08, 15, 16, *: all) |    |    |    |   | Default                   | DTMF receiver no. (1...6) |   |   |   |   |   |  |
|         | All                   | 07                                      | 08 | 15 | 16 | * | All                       | 1                         | 2 | 3 | 4 | 5 | 6 |  |
| Disable | ✓                     |   |    |    |    |   |                           |                           |   |   |   |   |   |  |
| Enable  |                       |   |    |    |    |   | ✓                         |                           |   |   |   |   |   |  |

|        | [103] DTMF Integration |         | [104] Hold Mode Selection |        |        | [105] Conference Tone |         | [106] External Paging Access Tone |         |
|--------|------------------------|---------|---------------------------|--------|--------|-----------------------|---------|-----------------------------------|---------|
|        | Enable                 | Disable | Hold-1                    | Hold-2 | Hold-3 | Enable                | Disable | Enable                            | Disable |
|        | Default                |         | ✓                         | ✓      |        |                       | ✓       |                                   | ✓       |
| Change |                        |         |                           |        |        |                       |         |                                   |         |

|        | [108] Flash Mode for a Station Locked Extension |         | [109] CO Indicator Assignment |         | [110] Flash Key Mode |        | [111] Hold Music Selection |          |      |
|--------|---|---------|-------------------------------|---------|----------------------|--------|----------------------------|----------|------|
|        | Enable  | Disable | Enable                        | Disable | MODE 1               | MODE 2 | Internal                   | External | Tone |
|        | Default   |         | ✓                             | ✓       |                      | ✓      |                            | ✓        |      |
| Change |   |         |                               |         |                      |        |                            |          |      |

|        | [112] DSS Console Indication Mode |         | [113] Automatic Redial Repeat |         |          |          | [114] Automatic Redial Interval Time |        |
|--------|-----------------------------------|---------|-------------------------------|---------|----------|----------|--------------------------------------|--------|
|        | Enable                            | Disable | 0 time                        | 3 times | 10 times | 15 times | 40 sec                               | 60 sec |
|        | Default                           | ✓       |                               |         |          | ✓        |                                      |        |
| Change |                                   |         |                               |         |          |          |                                      |        |

# 7 Programming Tables

|           | [115] Extension Ringing Pattern Selection |        |        | [116] Conference Pattern Selection |                 |                 |                 |
|-----------|---|--------|--------|------------------------------------|-----------------|-----------------|-----------------|
|           | Single                                    | Double | Triple | 3-Party C-0 E-3                    | 3-Party C-1 E-3 | 3-Party C-2 E-3 | 5-Party C-2 E-5 |
| Selection |   |        |        |                                    |                 |                 |                 |
| Default   |   | ✓      |        |                                    |                 |                 | ✓               |
| Change    |   |        |        |                                    |                 |                 |                 |

|           | [117] Call Pickup Tone |         | [118] Pulse Restriction |         | [119] Redialing after Pulse to Tone Conversion |         | [120] Bell Frequency |       |
|-----------|------------------------|---------|-------------------------|---------|--|---------|----------------------|-------|
|           | Enable                 | Disable | Enable                  | Disable | Enable   | Disable | 20 Hz                | 25 Hz |
| Selection |                        |         |                         |         |  |         |                      |       |
| Default   | ✓                      |         | ✓                       |         |  | ✓       |                      | ✓     |
| Change    |                        |         |                         |         |  |         |                      |       |

|           | [121] Automatic Outside (CO) Line Access Number Selection |   | [122] Automatic Rotation for Outside (CO) Line Access |         |
|-----------|---|---|---|---------|
|           | 0   | 9 | Enable  | Disable |
| Selection |   |   |   |         |
| Default   |   | ✓ |   | ✓       |
| Change    |   |   |   |         |

|           | [123] Break Ratio |        | [124] SLT Ringing Mode Selection |        | [125] Toll Restriction Check for * and # |         |
|-----------|-------------------|--------|----------------------------------|--------|--|---------|
|           | MODE 1            | MODE 2 | MODE 1                           | MODE 2 | Enable                                   | Disable |
| Selection |                   |        |                                  |        |  |         |
| Default   |                   | ✓      | ✓                                |        | ✓  |         |
| Change    |                   |        |                                  |        |  |         |

| [200] Hold Recall Time |        |       |         |       |       |       |       |       |         |
|------------------------|--------|-------|---------|-------|-------|-------|-------|-------|---------|
| Selection              | 30 sec | 1 min | 1.5 min | 2 min | 3 min | 4 min | 5 min | 6 min | Disable |
| Default                | ✓      |       |         |       |       |       |       |       |         |
| Change                 |        |       |         |       |       |       |       |       |         |

|           | [201] Transfer Recall Time |        |       |       | [202] Call Forwarding Start Time |        |        |        | [203] Pickup Dial Delay Time |       |       |       |
|-----------|----------------------------|--------|-------|-------|----------------------------------|--------|--------|--------|------------------------------|-------|-------|-------|
|           | 15 sec                     | 30 sec | 1 min | 2 min | 5 sec                            | 10 sec | 15 sec | 20 sec | 1 sec                        | 2 sec | 3 sec | 4 sec |
| Selection |                            |        |       |       |                                  |        |        |        |                              |       |       |       |
| Default   |                            | ✓      |       |       |                                  |        | ✓      |        |                              |       | ✓     |       |
| Change    |                            |        |       |       |                                  |        |        |        |                              |       |       |       |

| [204] Call Duration Count Start Time |       |        |        |        |        |        |        |        |        |        |           |
|--------------------------------------|-------|--------|--------|--------|--------|--------|--------|--------|--------|--------|-----------|
| Selection                            | 5 sec | 10 sec | 15 sec | 20 sec | 25 sec | 30 sec | 35 sec | 40 sec | 45 sec | 50 sec | Instantly |
| Default                              |       | ✓      |        |        |        |        |        |        |        |        |           |
| Change                               |       |        |        |        |        |        |        |        |        |        |           |

# 7 Programming Tables

|           | [205] Outside to Outside (CO to CO) Line Duration Time Limit | [206] Dialing Start Time |        |        |        |         |         |         |
|-----------|--|--------------------------|--------|--------|--------|---------|---------|---------|
|           |  | 0 ms                     | 250 ms | 500 ms | 750 ms | 1000 ms | 1250 ms | 1500 ms |
| Selection | 1...32 minutes   |                          |        |        |        |         |         |         |
| Default   | 10 minutes   | ✓                        |        |        |        |         |         |         |
| Change    |  |                          |        |        |        |         |         |         |

|           | [207] Hookswitch Flash Timing Range Selection |        |        |        |        | [208] Interdigit Time |        |        |
|-----------|---|--------|--------|--------|--------|-----------------------|--------|--------|
|           | MODE 1  | MODE 2 | MODE 3 | MODE 4 | MODE 5 | 5 sec                 | 10 sec | 15 sec |
| Selection |   |        |        | ✓      |        |                       | ✓      |        |
| Default   |   |        |        | ✓      |        |                       | ✓      |        |
| Change    |   |        |        |        |        |                       |        |        |

|           | [210] DTMF Time |        | [211] No Dial Disconnection |         | [212] Outside (CO) Line Duration Time Limit | [213] Bell Off Detection |       |        |
|-----------|-----------------|--------|-----------------------------|---------|---|--------------------------|-------|--------|
|           | MODE 1          | MODE 2 | Enable                      | Disable | 1...32 minutes                              | 3 sec                    | 6 sec | 12 sec |
| Selection | ✓               |        |                             | ✓       | 10 minutes                                  |                          | ✓     |        |
| Default   | ✓               |        |                             | ✓       | 10 minutes                                  |                          | ✓     |        |
| Change    |                 |        |                             |         |   |                          |       |        |

| [300] Carrier Code Assignment |                               |              |                               |
|-------------------------------|-------------------------------|--------------|-------------------------------|
| Location no.                  | Carrier code (10 digits max.) | Location no. | Carrier code (10 digits max.) |
| Default: All                  |                               | Not stored   |                               |
| 01                            |                               | 11           |                               |
| 02                            |                               | 12           |                               |
| 03                            |                               | 13           |                               |
| 04                            |                               | 14           |                               |
| 05                            |                               | 15           |                               |
| 06                            |                               | 16           |                               |
| 07                            |                               | 17           |                               |
| 08                            |                               | 18           |                               |
| 09                            |                               | 19           |                               |
| 10                            |                               | 20           |                               |

| [301] Toll Restriction — System Speed Dialing Boundary Class |         |         |         |         |         |
|--|---------|---------|---------|---------|---------|
| Selection  | Class-1 | Class-2 | Class-3 | Class-4 | Class-5 |
| Default  | ✓       |         |         |         |         |
| Change   |         |         |         |         |         |

# 7 *Programming Tables*

|          | [302] Toll Restriction –<br>for Class 2 Denied Codes | [303] Toll Restriction –<br>for Class 3 Denied Codes | [304] Toll Restriction –<br>for Class 4 Denied Codes | [305] Toll Restriction –<br>for Class 5 Denied Codes |
|----------|--|--|--|--|
| CODE no. | Telephone no. (10 digits)                            |  |  |  |
| Default  | All: Not stored                                      |  |  |  |
| 01       |  |  |  |  |
| 02       |  |  |  |  |
| 03       |  |  |  |  |
| 04       |  |  |  |  |
| 05       |  |  |  |  |
| 06       |  |  |  |  |
| 07       |  |  |  |  |
| 08       |  |  |  |  |
| 09       |  |  |  |  |
| 10       |  |  |  |  |
| 11       |  |  |  |  |
| 12       |  |  |  |  |
| 13       |  |  |  |  |
| 14       |  |  |  |  |
| 15       |  |  |  |  |
| 16       |  |  |  |  |
| 17       |  |  |  |  |
| 18       |  |  |  |  |
| 19       |  |  |  |  |
| 20       |  |  |  |  |

| <b>[306] Toll Restriction – Exception Codes</b> |                           |          |                           |
|---|---------------------------|----------|---------------------------|
| CODE no.  | Telephone no. (10 digits) | CODE no. | Telephone no. (10 digits) |
| Default   | All: Not stored           |          |                           |
| 01  |                           | 11       |                           |
| 02  |                           | 12       |                           |
| 03  |                           | 13       |                           |
| 04  |                           | 14       |                           |
| 05  |                           | 15       |                           |
| 06  |                           | 16       |                           |
| 07  |                           | 17       |                           |
| 08  |                           | 18       |                           |
| 09  |                           | 19       |                           |
| 10  |                           | 20       |                           |

## 7 *Programming Tables*

---

| <b>[309] Emergency Dial Number Set</b> |                                    |
|--|------------------------------------|
| CODE no.                               | Emergency call no. (4 digits max.) |
| Default                                | All: Not stored                    |
| 1                                      |                                    |
| 2                                      |                                    |
| 3                                      |                                    |
| 4                                      |                                    |
| 5                                      |                                    |

| <b>[310] Account Codes</b> |                             |          |                             |
|----------------------------|-----------------------------|----------|-----------------------------|
| CODE no.                   | Account code no. (4 digits) | CODE no. | Account code no. (4 digits) |
| Default                    | All: Not stored             |          |                             |
| 01                         |                             | 13       |                             |
| 02                         |                             | 14       |                             |
| 03                         |                             | 15       |                             |
| 04                         |                             | 16       |                             |
| 05                         |                             | 17       |                             |
| 06                         |                             | 18       |                             |
| 07                         |                             | 19       |                             |
| 08                         |                             | 20       |                             |
| 09                         |                             | 21       |                             |
| 10                         |                             | 22       |                             |
| 11                         |                             | 23       |                             |
| 12                         |                             | 24       |                             |

# 7 *Programming Tables*

| <b>[311] Automatic Pause Insertion Codes</b> |                                |                 |                                |
|--|--------------------------------|-----------------|--------------------------------|
| CODE no.                                     | Pause code no. (7 digits max.) | CODE no.        | Pause code no. (7 digits max.) |
| Default                                      |                                | All: Not stored |                                |
| 01   |                                | 21              |                                |
| 02   |                                | 22              |                                |
| 03   |                                | 23              |                                |
| 04   |                                | 24              |                                |
| 05   |                                | 25              |                                |
| 06   |                                | 26              |                                |
| 07   |                                | 27              |                                |
| 08   |                                | 28              |                                |
| 09   |                                | 29              |                                |
| 10   |                                | 30              |                                |
| 11   |                                | 31              |                                |
| 12   |                                | 32              |                                |
| 13   |                                | 33              |                                |
| 14   |                                | 34              |                                |
| 15   |                                | 35              |                                |
| 16   |                                | 36              |                                |
| 17   |                                | 37              |                                |
| 18   |                                | 38              |                                |
| 19   |                                | 39              |                                |
| 20   |                                | 40              |                                |

| <b>[312] Toll Restriction – Station Lock Boundary Class</b> |         |        |
|---|---------|--------|
|   | Default | Change |
| Disable   | ✓       |        |
| COS-2   |         |        |
| COS-3   |         |        |
| COS-4   |         |        |
| COS-5   |         |        |

|                  | <b>[400] Outside (CO) Line Connection Assignment</b> |            | <b>[401] Dial Mode</b> |       |               | <b>[402] Pulse Speed Selection</b> |            |
|------------------|--|------------|------------------------|-------|---------------|------------------------------------|------------|
|                  | Selection  |            | Selection              |       |               | Selection                          |            |
| Outside line no. | Connect  | No Connect | DTMF                   | Pulse | Call Blocking | Low Speed                          | High Speed |
| Default: All     | ✓  |            |                        | ✓     |               | ✓                                  |            |
| 1                |  |            |                        |       |               |                                    |            |
| 2                |  |            |                        |       |               |                                    |            |
| 3                |  |            |                        |       |               |                                    |            |
| 4                |  |            |                        |       |               |                                    |            |
| 5                |  |            |                        |       |               |                                    |            |
| 6                |  |            |                        |       |               |                                    |            |
| *                |  |            |                        |       |               |                                    |            |

# 7 Programming Tables

|                  | [403] Host PBX Access Code                             | [404] Outside (CO) Line Group Assignment |        |
|------------------|--|--|--------|
| Outside line no. | Access code<br>(1 or 2 digits, 8 different codes max.) | Outside line group no.<br>(1...6)        |        |
| Default          | All: Not stored  | Default                                  | Change |
| 1                |  | 1  |        |
| 2                |  | 2  |        |
| 3                |  | 3  |        |
| 4                |  | 4  |        |
| 5                |  | 5  |        |
| 6                |  | 6  |        |
| *                |  | —  |        |

| [405] Flexible Outward Dialing Assignment — Day |                |                |                |                |                |                |         |         |        |         |        |         |        |         |
|---|----------------|----------------|----------------|----------------|----------------|----------------|---------|---------|--------|---------|--------|---------|--------|---------|
| Extension jack no.                              | Outside line 1 | Outside line 2 | Outside line 3 | Outside line 4 | Outside line 5 | Outside line 6 | * (All) |         |        |         |        |         |        |         |
|   | Selection      |                |                |                |                |                |         |         |        |         |        |         |        |         |
|   | Enable         | Disable        | Enable         | Disable        | Enable         | Disable        | Enable  | Disable | Enable | Disable | Enable | Disable | Enable | Disable |
| Default: All                                    | ✓              |                | ✓              |                | ✓              |                | ✓       |         | ✓      |         | ✓      |         | ✓      |         |
| 01  |                |                |                |                |                |                |         |         |        |         |        |         |        |         |
| 02  |                |                |                |                |                |                |         |         |        |         |        |         |        |         |
| 03  |                |                |                |                |                |                |         |         |        |         |        |         |        |         |
| 04  |                |                |                |                |                |                |         |         |        |         |        |         |        |         |
| 05  |                |                |                |                |                |                |         |         |        |         |        |         |        |         |
| 06  |                |                |                |                |                |                |         |         |        |         |        |         |        |         |
| 07  |                |                |                |                |                |                |         |         |        |         |        |         |        |         |
| 08  |                |                |                |                |                |                |         |         |        |         |        |         |        |         |
| 09  |                |                |                |                |                |                |         |         |        |         |        |         |        |         |
| 10  |                |                |                |                |                |                |         |         |        |         |        |         |        |         |
| 11  |                |                |                |                |                |                |         |         |        |         |        |         |        |         |
| 12  |                |                |                |                |                |                |         |         |        |         |        |         |        |         |
| 13  |                |                |                |                |                |                |         |         |        |         |        |         |        |         |
| 14  |                |                |                |                |                |                |         |         |        |         |        |         |        |         |
| 15  |                |                |                |                |                |                |         |         |        |         |        |         |        |         |
| 16  |                |                |                |                |                |                |         |         |        |         |        |         |        |         |
| 17  |                |                |                |                |                |                |         |         |        |         |        |         |        |         |
| 18  |                |                |                |                |                |                |         |         |        |         |        |         |        |         |
| 19  |                |                |                |                |                |                |         |         |        |         |        |         |        |         |
| 20  |                |                |                |                |                |                |         |         |        |         |        |         |        |         |
| 21  |                |                |                |                |                |                |         |         |        |         |        |         |        |         |
| 22  |                |                |                |                |                |                |         |         |        |         |        |         |        |         |
| 23  |                |                |                |                |                |                |         |         |        |         |        |         |        |         |
| 24  |                |                |                |                |                |                |         |         |        |         |        |         |        |         |
| *   |                |                |                |                |                |                |         |         |        |         |        |         |        |         |

# 7

## Programming Tables

| [406] Flexible Outward Dialing Assignment — Night |                |         |                |         |                |         |                |         |                |         |                |         |         |         |
|---|----------------|---------|----------------|---------|----------------|---------|----------------|---------|----------------|---------|----------------|---------|---------|---------|
| Extension<br>jack no.                             | Outside line 1 |         | Outside line 2 |         | Outside line 3 |         | Outside line 4 |         | Outside line 5 |         | Outside line 6 |         | * (All) |         |
|   | Selection      |         |                |         |                |         |                |         |                |         |                |         |         |         |
|   | Enable         | Disable | Enable         | Disable | Enable         | Disable | Enable         | Disable | Enable         | Disable | Enable         | Disable | Enable  | Disable |
| Default: All                                      | ✓              |         | ✓              |         | ✓              |         | ✓              |         | ✓              |         | ✓              |         | ✓       |         |
| 01  |                |         |                |         |                |         |                |         |                |         |                |         |         |         |
| 02  |                |         |                |         |                |         |                |         |                |         |                |         |         |         |
| 03  |                |         |                |         |                |         |                |         |                |         |                |         |         |         |
| 04  |                |         |                |         |                |         |                |         |                |         |                |         |         |         |
| 05  |                |         |                |         |                |         |                |         |                |         |                |         |         |         |
| 06  |                |         |                |         |                |         |                |         |                |         |                |         |         |         |
| 07  |                |         |                |         |                |         |                |         |                |         |                |         |         |         |
| 08  |                |         |                |         |                |         |                |         |                |         |                |         |         |         |
| 09  |                |         |                |         |                |         |                |         |                |         |                |         |         |         |
| 10  |                |         |                |         |                |         |                |         |                |         |                |         |         |         |
| 11  |                |         |                |         |                |         |                |         |                |         |                |         |         |         |
| 12  |                |         |                |         |                |         |                |         |                |         |                |         |         |         |
| 13  |                |         |                |         |                |         |                |         |                |         |                |         |         |         |
| 14  |                |         |                |         |                |         |                |         |                |         |                |         |         |         |
| 15  |                |         |                |         |                |         |                |         |                |         |                |         |         |         |
| 16  |                |         |                |         |                |         |                |         |                |         |                |         |         |         |
| 17  |                |         |                |         |                |         |                |         |                |         |                |         |         |         |
| 18  |                |         |                |         |                |         |                |         |                |         |                |         |         |         |
| 19  |                |         |                |         |                |         |                |         |                |         |                |         |         |         |
| 20  |                |         |                |         |                |         |                |         |                |         |                |         |         |         |
| 21  |                |         |                |         |                |         |                |         |                |         |                |         |         |         |
| 22  |                |         |                |         |                |         |                |         |                |         |                |         |         |         |
| 23  |                |         |                |         |                |         |                |         |                |         |                |         |         |         |
| 24  |                |         |                |         |                |         |                |         |                |         |                |         |         |         |
| *   |                |         |                |         |                |         |                |         |                |         |                |         |         |         |

# 7

## Programming Tables

| [407] Flexible Outward Dialing Assignment — Lunch |                |         |                |         |                |         |                |         |                |         |                |         |         |         |
|---|----------------|---------|----------------|---------|----------------|---------|----------------|---------|----------------|---------|----------------|---------|---------|---------|
| Extension<br>jack no.                             | Outside line 1 |         | Outside line 2 |         | Outside line 3 |         | Outside line 4 |         | Outside line 5 |         | Outside line 6 |         | * (All) |         |
|   | Selection      |         |                |         |                |         |                |         |                |         |                |         |         |         |
|   | Enable         | Disable | Enable         | Disable | Enable         | Disable | Enable         | Disable | Enable         | Disable | Enable         | Disable | Enable  | Disable |
| Default: All                                      | ✓              |         | ✓              |         | ✓              |         | ✓              |         | ✓              |         | ✓              |         | ✓       |         |
| 01  |                |         |                |         |                |         |                |         |                |         |                |         |         |         |
| 02  |                |         |                |         |                |         |                |         |                |         |                |         |         |         |
| 03  |                |         |                |         |                |         |                |         |                |         |                |         |         |         |
| 04  |                |         |                |         |                |         |                |         |                |         |                |         |         |         |
| 05  |                |         |                |         |                |         |                |         |                |         |                |         |         |         |
| 06  |                |         |                |         |                |         |                |         |                |         |                |         |         |         |
| 07  |                |         |                |         |                |         |                |         |                |         |                |         |         |         |
| 08  |                |         |                |         |                |         |                |         |                |         |                |         |         |         |
| 09  |                |         |                |         |                |         |                |         |                |         |                |         |         |         |
| 10  |                |         |                |         |                |         |                |         |                |         |                |         |         |         |
| 11  |                |         |                |         |                |         |                |         |                |         |                |         |         |         |
| 12  |                |         |                |         |                |         |                |         |                |         |                |         |         |         |
| 13  |                |         |                |         |                |         |                |         |                |         |                |         |         |         |
| 14  |                |         |                |         |                |         |                |         |                |         |                |         |         |         |
| 15  |                |         |                |         |                |         |                |         |                |         |                |         |         |         |
| 16  |                |         |                |         |                |         |                |         |                |         |                |         |         |         |
| 17  |                |         |                |         |                |         |                |         |                |         |                |         |         |         |
| 18  |                |         |                |         |                |         |                |         |                |         |                |         |         |         |
| 19  |                |         |                |         |                |         |                |         |                |         |                |         |         |         |
| 20  |                |         |                |         |                |         |                |         |                |         |                |         |         |         |
| 21  |                |         |                |         |                |         |                |         |                |         |                |         |         |         |
| 22  |                |         |                |         |                |         |                |         |                |         |                |         |         |         |
| 23  |                |         |                |         |                |         |                |         |                |         |                |         |         |         |
| 24  |                |         |                |         |                |         |                |         |                |         |                |         |         |         |
| *   |                |         |                |         |                |         |                |         |                |         |                |         |         |         |

# 7 *Programming Tables*

| [408] Flexible Ringing Assignment — Day |                |         |                |         |                |         |                |         |                |         |                |         |         |         |
|---|----------------|---------|----------------|---------|----------------|---------|----------------|---------|----------------|---------|----------------|---------|---------|---------|
| Extension<br>jack no.                   | Outside line 1 |         | Outside line 2 |         | Outside line 3 |         | Outside line 4 |         | Outside line 5 |         | Outside line 6 |         | * (All) |         |
|   | Selection      |         |                |         |                |         |                |         |                |         |                |         |         |         |
|   | Enable         | Disable | Enable         | Disable | Enable         | Disable | Enable         | Disable | Enable         | Disable | Enable         | Disable | Enable  | Disable |
| Default: All                            | ✓              |         | ✓              |         | ✓              |         | ✓              |         | ✓              |         | ✓              |         | ✓       |         |
| 01                                      |                |         |                |         |                |         |                |         |                |         |                |         |         |         |
| 02                                      |                |         |                |         |                |         |                |         |                |         |                |         |         |         |
| 03                                      |                |         |                |         |                |         |                |         |                |         |                |         |         |         |
| 04                                      |                |         |                |         |                |         |                |         |                |         |                |         |         |         |
| 05                                      |                |         |                |         |                |         |                |         |                |         |                |         |         |         |
| 06                                      |                |         |                |         |                |         |                |         |                |         |                |         |         |         |
| 07                                      |                |         |                |         |                |         |                |         |                |         |                |         |         |         |
| 08                                      |                |         |                |         |                |         |                |         |                |         |                |         |         |         |
| 09                                      |                |         |                |         |                |         |                |         |                |         |                |         |         |         |
| 10                                      |                |         |                |         |                |         |                |         |                |         |                |         |         |         |
| 11                                      |                |         |                |         |                |         |                |         |                |         |                |         |         |         |
| 12                                      |                |         |                |         |                |         |                |         |                |         |                |         |         |         |
| 13                                      |                |         |                |         |                |         |                |         |                |         |                |         |         |         |
| 14                                      |                |         |                |         |                |         |                |         |                |         |                |         |         |         |
| 15                                      |                |         |                |         |                |         |                |         |                |         |                |         |         |         |
| 16                                      |                |         |                |         |                |         |                |         |                |         |                |         |         |         |
| 17                                      |                |         |                |         |                |         |                |         |                |         |                |         |         |         |
| 18                                      |                |         |                |         |                |         |                |         |                |         |                |         |         |         |
| 19                                      |                |         |                |         |                |         |                |         |                |         |                |         |         |         |
| 20                                      |                |         |                |         |                |         |                |         |                |         |                |         |         |         |
| 21                                      |                |         |                |         |                |         |                |         |                |         |                |         |         |         |
| 22                                      |                |         |                |         |                |         |                |         |                |         |                |         |         |         |
| 23                                      |                |         |                |         |                |         |                |         |                |         |                |         |         |         |
| 24                                      |                |         |                |         |                |         |                |         |                |         |                |         |         |         |
| *                                       |                |         |                |         |                |         |                |         |                |         |                |         |         |         |

# 7

## Programming Tables

| [409] Flexible Ringing Assignment — Night |                |         |                |         |                |         |                |         |                |         |                |         |         |         |
|---|----------------|---------|----------------|---------|----------------|---------|----------------|---------|----------------|---------|----------------|---------|---------|---------|
| Extension<br>jack no.                     | Outside line 1 |         | Outside line 2 |         | Outside line 3 |         | Outside line 4 |         | Outside line 5 |         | Outside line 6 |         | * (All) |         |
|   | Selection      |         |                |         |                |         |                |         |                |         |                |         |         |         |
|   | Enable         | Disable | Enable         | Disable | Enable         | Disable | Enable         | Disable | Enable         | Disable | Enable         | Disable | Enable  | Disable |
| Default: All                              | ✓              |         | ✓              |         | ✓              |         | ✓              |         | ✓              |         | ✓              |         | ✓       |         |
| 01  |                |         |                |         |                |         |                |         |                |         |                |         |         |         |
| 02  |                |         |                |         |                |         |                |         |                |         |                |         |         |         |
| 03  |                |         |                |         |                |         |                |         |                |         |                |         |         |         |
| 04  |                |         |                |         |                |         |                |         |                |         |                |         |         |         |
| 05  |                |         |                |         |                |         |                |         |                |         |                |         |         |         |
| 06  |                |         |                |         |                |         |                |         |                |         |                |         |         |         |
| 07  |                |         |                |         |                |         |                |         |                |         |                |         |         |         |
| 08  |                |         |                |         |                |         |                |         |                |         |                |         |         |         |
| 09  |                |         |                |         |                |         |                |         |                |         |                |         |         |         |
| 10  |                |         |                |         |                |         |                |         |                |         |                |         |         |         |
| 11  |                |         |                |         |                |         |                |         |                |         |                |         |         |         |
| 12  |                |         |                |         |                |         |                |         |                |         |                |         |         |         |
| 13  |                |         |                |         |                |         |                |         |                |         |                |         |         |         |
| 14  |                |         |                |         |                |         |                |         |                |         |                |         |         |         |
| 15  |                |         |                |         |                |         |                |         |                |         |                |         |         |         |
| 16  |                |         |                |         |                |         |                |         |                |         |                |         |         |         |
| 17  |                |         |                |         |                |         |                |         |                |         |                |         |         |         |
| 18  |                |         |                |         |                |         |                |         |                |         |                |         |         |         |
| 19  |                |         |                |         |                |         |                |         |                |         |                |         |         |         |
| 20  |                |         |                |         |                |         |                |         |                |         |                |         |         |         |
| 21  |                |         |                |         |                |         |                |         |                |         |                |         |         |         |
| 22  |                |         |                |         |                |         |                |         |                |         |                |         |         |         |
| 23  |                |         |                |         |                |         |                |         |                |         |                |         |         |         |
| 24  |                |         |                |         |                |         |                |         |                |         |                |         |         |         |
| *   |                |         |                |         |                |         |                |         |                |         |                |         |         |         |

# 7 *Programming Tables*

| [410] Flexible Ringing Assignment — Lunch |                |         |                |         |                |         |                |         |                |         |                |         |         |         |
|---|----------------|---------|----------------|---------|----------------|---------|----------------|---------|----------------|---------|----------------|---------|---------|---------|
| Extension<br>jack no.                     | Outside line 1 |         | Outside line 2 |         | Outside line 3 |         | Outside line 4 |         | Outside line 5 |         | Outside line 6 |         | * (All) |         |
|   | Selection      |         |                |         |                |         |                |         |                |         |                |         |         |         |
|   | Enable         | Disable | Enable         | Disable | Enable         | Disable | Enable         | Disable | Enable         | Disable | Enable         | Disable | Enable  | Disable |
| Default: All                              | ✓              |         | ✓              |         | ✓              |         | ✓              |         | ✓              |         | ✓              |         | ✓       |         |
| 01  |                |         |                |         |                |         |                |         |                |         |                |         |         |         |
| 02  |                |         |                |         |                |         |                |         |                |         |                |         |         |         |
| 03  |                |         |                |         |                |         |                |         |                |         |                |         |         |         |
| 04  |                |         |                |         |                |         |                |         |                |         |                |         |         |         |
| 05  |                |         |                |         |                |         |                |         |                |         |                |         |         |         |
| 06  |                |         |                |         |                |         |                |         |                |         |                |         |         |         |
| 07  |                |         |                |         |                |         |                |         |                |         |                |         |         |         |
| 08  |                |         |                |         |                |         |                |         |                |         |                |         |         |         |
| 09  |                |         |                |         |                |         |                |         |                |         |                |         |         |         |
| 10  |                |         |                |         |                |         |                |         |                |         |                |         |         |         |
| 11  |                |         |                |         |                |         |                |         |                |         |                |         |         |         |
| 12  |                |         |                |         |                |         |                |         |                |         |                |         |         |         |
| 13  |                |         |                |         |                |         |                |         |                |         |                |         |         |         |
| 14  |                |         |                |         |                |         |                |         |                |         |                |         |         |         |
| 15  |                |         |                |         |                |         |                |         |                |         |                |         |         |         |
| 16  |                |         |                |         |                |         |                |         |                |         |                |         |         |         |
| 17  |                |         |                |         |                |         |                |         |                |         |                |         |         |         |
| 18  |                |         |                |         |                |         |                |         |                |         |                |         |         |         |
| 19  |                |         |                |         |                |         |                |         |                |         |                |         |         |         |
| 20  |                |         |                |         |                |         |                |         |                |         |                |         |         |         |
| 21  |                |         |                |         |                |         |                |         |                |         |                |         |         |         |
| 22  |                |         |                |         |                |         |                |         |                |         |                |         |         |         |
| 23  |                |         |                |         |                |         |                |         |                |         |                |         |         |         |
| 24  |                |         |                |         |                |         |                |         |                |         |                |         |         |         |
| *   |                |         |                |         |                |         |                |         |                |         |                |         |         |         |

# 7 *Programming Tables*

| [411] Delayed Ringing Assignment — Day |  |   |    |    |                |   |    |    |                |   |    |    |                |   |    |    |                |   |    |    |                |   |    |    |         |   |    |    |   |   |    |    |
|--|--|---|----|----|----------------|---|----|----|----------------|---|----|----|----------------|---|----|----|----------------|---|----|----|----------------|---|----|----|---------|---|----|----|---|---|----|----|
| Extension<br>jack no.                  | Outside line 1   |   |    |    | Outside line 2 |   |    |    | Outside line 3 |   |    |    | Outside line 4 |   |    |    | Outside line 5 |   |    |    | Outside line 6 |   |    |    | * (All) |   |    |    |   |   |    |    |
|  | Selection (I: Immediately, 5: 5 seconds delay, 10: 10 seconds delay, 15: 15 seconds delay) |   |    |    |                |   |    |    |                |   |    |    |                |   |    |    |                |   |    |    |                |   |    |    |         |   |    |    |   |   |    |    |
|  | I  | 5 | 10 | 15 | I              | 5 | 10 | 15 | I              | 5 | 10 | 15 | I              | 5 | 10 | 15 | I              | 5 | 10 | 15 | I              | 5 | 10 | 15 | I       | 5 | 10 | 15 | I | 5 | 10 | 15 |
| Default: All                           | ✓  |   |    |    | ✓              |   |    |    | ✓              |   |    |    | ✓              |   |    |    | ✓              |   |    |    | ✓              |   |    |    | ✓       |   |    |    | ✓ |   |    |    |
| 01                                     |  |   |    |    |                |   |    |    |                |   |    |    |                |   |    |    |                |   |    |    |                |   |    |    |         |   |    |    |   |   |    |    |
| 02                                     |  |   |    |    |                |   |    |    |                |   |    |    |                |   |    |    |                |   |    |    |                |   |    |    |         |   |    |    |   |   |    |    |
| 03                                     |  |   |    |    |                |   |    |    |                |   |    |    |                |   |    |    |                |   |    |    |                |   |    |    |         |   |    |    |   |   |    |    |
| 04                                     |  |   |    |    |                |   |    |    |                |   |    |    |                |   |    |    |                |   |    |    |                |   |    |    |         |   |    |    |   |   |    |    |
| 05                                     |  |   |    |    |                |   |    |    |                |   |    |    |                |   |    |    |                |   |    |    |                |   |    |    |         |   |    |    |   |   |    |    |
| 06                                     |  |   |    |    |                |   |    |    |                |   |    |    |                |   |    |    |                |   |    |    |                |   |    |    |         |   |    |    |   |   |    |    |
| 07                                     |  |   |    |    |                |   |    |    |                |   |    |    |                |   |    |    |                |   |    |    |                |   |    |    |         |   |    |    |   |   |    |    |
| 08                                     |  |   |    |    |                |   |    |    |                |   |    |    |                |   |    |    |                |   |    |    |                |   |    |    |         |   |    |    |   |   |    |    |
| 09                                     |  |   |    |    |                |   |    |    |                |   |    |    |                |   |    |    |                |   |    |    |                |   |    |    |         |   |    |    |   |   |    |    |
| 10                                     |  |   |    |    |                |   |    |    |                |   |    |    |                |   |    |    |                |   |    |    |                |   |    |    |         |   |    |    |   |   |    |    |
| 11                                     |  |   |    |    |                |   |    |    |                |   |    |    |                |   |    |    |                |   |    |    |                |   |    |    |         |   |    |    |   |   |    |    |
| 12                                     |  |   |    |    |                |   |    |    |                |   |    |    |                |   |    |    |                |   |    |    |                |   |    |    |         |   |    |    |   |   |    |    |
| 13                                     |  |   |    |    |                |   |    |    |                |   |    |    |                |   |    |    |                |   |    |    |                |   |    |    |         |   |    |    |   |   |    |    |
| 14                                     |  |   |    |    |                |   |    |    |                |   |    |    |                |   |    |    |                |   |    |    |                |   |    |    |         |   |    |    |   |   |    |    |
| 15                                     |  |   |    |    |                |   |    |    |                |   |    |    |                |   |    |    |                |   |    |    |                |   |    |    |         |   |    |    |   |   |    |    |
| 16                                     |  |   |    |    |                |   |    |    |                |   |    |    |                |   |    |    |                |   |    |    |                |   |    |    |         |   |    |    |   |   |    |    |
| 17                                     |  |   |    |    |                |   |    |    |                |   |    |    |                |   |    |    |                |   |    |    |                |   |    |    |         |   |    |    |   |   |    |    |
| 18                                     |  |   |    |    |                |   |    |    |                |   |    |    |                |   |    |    |                |   |    |    |                |   |    |    |         |   |    |    |   |   |    |    |
| 19                                     |  |   |    |    |                |   |    |    |                |   |    |    |                |   |    |    |                |   |    |    |                |   |    |    |         |   |    |    |   |   |    |    |
| 20                                     |  |   |    |    |                |   |    |    |                |   |    |    |                |   |    |    |                |   |    |    |                |   |    |    |         |   |    |    |   |   |    |    |
| 21                                     |  |   |    |    |                |   |    |    |                |   |    |    |                |   |    |    |                |   |    |    |                |   |    |    |         |   |    |    |   |   |    |    |
| 22                                     |  |   |    |    |                |   |    |    |                |   |    |    |                |   |    |    |                |   |    |    |                |   |    |    |         |   |    |    |   |   |    |    |
| 23                                     |  |   |    |    |                |   |    |    |                |   |    |    |                |   |    |    |                |   |    |    |                |   |    |    |         |   |    |    |   |   |    |    |
| 24                                     |  |   |    |    |                |   |    |    |                |   |    |    |                |   |    |    |                |   |    |    |                |   |    |    |         |   |    |    |   |   |    |    |
| *                                      |  |   |    |    |                |   |    |    |                |   |    |    |                |   |    |    |                |   |    |    |                |   |    |    |         |   |    |    |   |   |    |    |

# 7 *Programming Tables*

| [412] Delayed Ringing Assignment — Night |  |   |    |    |                |   |    |    |                |   |    |    |                |   |    |    |                |   |    |    |                |   |    |    |         |   |    |    |   |   |    |    |
|--|--|---|----|----|----------------|---|----|----|----------------|---|----|----|----------------|---|----|----|----------------|---|----|----|----------------|---|----|----|---------|---|----|----|---|---|----|----|
| Extension<br>jack no.                    | Outside line 1   |   |    |    | Outside line 2 |   |    |    | Outside line 3 |   |    |    | Outside line 4 |   |    |    | Outside line 5 |   |    |    | Outside line 6 |   |    |    | * (All) |   |    |    |   |   |    |    |
|  | Selection (I: Immediately, 5: 5 seconds delay, 10: 10 seconds delay, 15: 15 seconds delay) |   |    |    |                |   |    |    |                |   |    |    |                |   |    |    |                |   |    |    |                |   |    |    |         |   |    |    |   |   |    |    |
|  | I  | 5 | 10 | 15 | I              | 5 | 10 | 15 | I              | 5 | 10 | 15 | I              | 5 | 10 | 15 | I              | 5 | 10 | 15 | I              | 5 | 10 | 15 | I       | 5 | 10 | 15 | I | 5 | 10 | 15 |
| Default: All                             | ✓  |   |    |    | ✓              |   |    |    | ✓              |   |    |    | ✓              |   |    |    | ✓              |   |    |    | ✓              |   |    |    | ✓       |   |    |    | ✓ |   |    |    |
| 01                                       |  |   |    |    |                |   |    |    |                |   |    |    |                |   |    |    |                |   |    |    |                |   |    |    |         |   |    |    |   |   |    |    |
| 02                                       |  |   |    |    |                |   |    |    |                |   |    |    |                |   |    |    |                |   |    |    |                |   |    |    |         |   |    |    |   |   |    |    |
| 03                                       |  |   |    |    |                |   |    |    |                |   |    |    |                |   |    |    |                |   |    |    |                |   |    |    |         |   |    |    |   |   |    |    |
| 04                                       |  |   |    |    |                |   |    |    |                |   |    |    |                |   |    |    |                |   |    |    |                |   |    |    |         |   |    |    |   |   |    |    |
| 05                                       |  |   |    |    |                |   |    |    |                |   |    |    |                |   |    |    |                |   |    |    |                |   |    |    |         |   |    |    |   |   |    |    |
| 06                                       |  |   |    |    |                |   |    |    |                |   |    |    |                |   |    |    |                |   |    |    |                |   |    |    |         |   |    |    |   |   |    |    |
| 07                                       |  |   |    |    |                |   |    |    |                |   |    |    |                |   |    |    |                |   |    |    |                |   |    |    |         |   |    |    |   |   |    |    |
| 08                                       |  |   |    |    |                |   |    |    |                |   |    |    |                |   |    |    |                |   |    |    |                |   |    |    |         |   |    |    |   |   |    |    |
| 09                                       |  |   |    |    |                |   |    |    |                |   |    |    |                |   |    |    |                |   |    |    |                |   |    |    |         |   |    |    |   |   |    |    |
| 10                                       |  |   |    |    |                |   |    |    |                |   |    |    |                |   |    |    |                |   |    |    |                |   |    |    |         |   |    |    |   |   |    |    |
| 11                                       |  |   |    |    |                |   |    |    |                |   |    |    |                |   |    |    |                |   |    |    |                |   |    |    |         |   |    |    |   |   |    |    |
| 12                                       |  |   |    |    |                |   |    |    |                |   |    |    |                |   |    |    |                |   |    |    |                |   |    |    |         |   |    |    |   |   |    |    |
| 13                                       |  |   |    |    |                |   |    |    |                |   |    |    |                |   |    |    |                |   |    |    |                |   |    |    |         |   |    |    |   |   |    |    |
| 14                                       |  |   |    |    |                |   |    |    |                |   |    |    |                |   |    |    |                |   |    |    |                |   |    |    |         |   |    |    |   |   |    |    |
| 15                                       |  |   |    |    |                |   |    |    |                |   |    |    |                |   |    |    |                |   |    |    |                |   |    |    |         |   |    |    |   |   |    |    |
| 16                                       |  |   |    |    |                |   |    |    |                |   |    |    |                |   |    |    |                |   |    |    |                |   |    |    |         |   |    |    |   |   |    |    |
| 17                                       |  |   |    |    |                |   |    |    |                |   |    |    |                |   |    |    |                |   |    |    |                |   |    |    |         |   |    |    |   |   |    |    |
| 18                                       |  |   |    |    |                |   |    |    |                |   |    |    |                |   |    |    |                |   |    |    |                |   |    |    |         |   |    |    |   |   |    |    |
| 19                                       |  |   |    |    |                |   |    |    |                |   |    |    |                |   |    |    |                |   |    |    |                |   |    |    |         |   |    |    |   |   |    |    |
| 20                                       |  |   |    |    |                |   |    |    |                |   |    |    |                |   |    |    |                |   |    |    |                |   |    |    |         |   |    |    |   |   |    |    |
| 21                                       |  |   |    |    |                |   |    |    |                |   |    |    |                |   |    |    |                |   |    |    |                |   |    |    |         |   |    |    |   |   |    |    |
| 22                                       |  |   |    |    |                |   |    |    |                |   |    |    |                |   |    |    |                |   |    |    |                |   |    |    |         |   |    |    |   |   |    |    |
| 23                                       |  |   |    |    |                |   |    |    |                |   |    |    |                |   |    |    |                |   |    |    |                |   |    |    |         |   |    |    |   |   |    |    |
| 24                                       |  |   |    |    |                |   |    |    |                |   |    |    |                |   |    |    |                |   |    |    |                |   |    |    |         |   |    |    |   |   |    |    |
| *  |  |   |    |    |                |   |    |    |                |   |    |    |                |   |    |    |                |   |    |    |                |   |    |    |         |   |    |    |   |   |    |    |

# 7 *Programming Tables*

| [413] Delayed Ringing Assignment — Lunch |  |   |    |    |                |   |    |    |                |   |    |    |                |   |    |    |                |   |    |    |                |   |    |    |         |   |    |    |   |   |    |    |
|--|--|---|----|----|----------------|---|----|----|----------------|---|----|----|----------------|---|----|----|----------------|---|----|----|----------------|---|----|----|---------|---|----|----|---|---|----|----|
| Extension<br>jack no.                    | Outside line 1   |   |    |    | Outside line 2 |   |    |    | Outside line 3 |   |    |    | Outside line 4 |   |    |    | Outside line 5 |   |    |    | Outside line 6 |   |    |    | * (All) |   |    |    |   |   |    |    |
|  | Selection (I: Immediately, 5: 5 seconds delay, 10: 10 seconds delay, 15: 15 seconds delay) |   |    |    |                |   |    |    |                |   |    |    |                |   |    |    |                |   |    |    |                |   |    |    |         |   |    |    |   |   |    |    |
|  | I  | 5 | 10 | 15 | I              | 5 | 10 | 15 | I              | 5 | 10 | 15 | I              | 5 | 10 | 15 | I              | 5 | 10 | 15 | I              | 5 | 10 | 15 | I       | 5 | 10 | 15 | I | 5 | 10 | 15 |
| Default: All                             | ✓  |   |    |    | ✓              |   |    |    | ✓              |   |    |    | ✓              |   |    |    | ✓              |   |    |    | ✓              |   |    |    | ✓       |   |    |    | ✓ |   |    |    |
| 01                                       |  |   |    |    |                |   |    |    |                |   |    |    |                |   |    |    |                |   |    |    |                |   |    |    |         |   |    |    |   |   |    |    |
| 02                                       |  |   |    |    |                |   |    |    |                |   |    |    |                |   |    |    |                |   |    |    |                |   |    |    |         |   |    |    |   |   |    |    |
| 03                                       |  |   |    |    |                |   |    |    |                |   |    |    |                |   |    |    |                |   |    |    |                |   |    |    |         |   |    |    |   |   |    |    |
| 04                                       |  |   |    |    |                |   |    |    |                |   |    |    |                |   |    |    |                |   |    |    |                |   |    |    |         |   |    |    |   |   |    |    |
| 05                                       |  |   |    |    |                |   |    |    |                |   |    |    |                |   |    |    |                |   |    |    |                |   |    |    |         |   |    |    |   |   |    |    |
| 06                                       |  |   |    |    |                |   |    |    |                |   |    |    |                |   |    |    |                |   |    |    |                |   |    |    |         |   |    |    |   |   |    |    |
| 07                                       |  |   |    |    |                |   |    |    |                |   |    |    |                |   |    |    |                |   |    |    |                |   |    |    |         |   |    |    |   |   |    |    |
| 08                                       |  |   |    |    |                |   |    |    |                |   |    |    |                |   |    |    |                |   |    |    |                |   |    |    |         |   |    |    |   |   |    |    |
| 09                                       |  |   |    |    |                |   |    |    |                |   |    |    |                |   |    |    |                |   |    |    |                |   |    |    |         |   |    |    |   |   |    |    |
| 10                                       |  |   |    |    |                |   |    |    |                |   |    |    |                |   |    |    |                |   |    |    |                |   |    |    |         |   |    |    |   |   |    |    |
| 11                                       |  |   |    |    |                |   |    |    |                |   |    |    |                |   |    |    |                |   |    |    |                |   |    |    |         |   |    |    |   |   |    |    |
| 12                                       |  |   |    |    |                |   |    |    |                |   |    |    |                |   |    |    |                |   |    |    |                |   |    |    |         |   |    |    |   |   |    |    |
| 13                                       |  |   |    |    |                |   |    |    |                |   |    |    |                |   |    |    |                |   |    |    |                |   |    |    |         |   |    |    |   |   |    |    |
| 14                                       |  |   |    |    |                |   |    |    |                |   |    |    |                |   |    |    |                |   |    |    |                |   |    |    |         |   |    |    |   |   |    |    |
| 15                                       |  |   |    |    |                |   |    |    |                |   |    |    |                |   |    |    |                |   |    |    |                |   |    |    |         |   |    |    |   |   |    |    |
| 16                                       |  |   |    |    |                |   |    |    |                |   |    |    |                |   |    |    |                |   |    |    |                |   |    |    |         |   |    |    |   |   |    |    |
| 17                                       |  |   |    |    |                |   |    |    |                |   |    |    |                |   |    |    |                |   |    |    |                |   |    |    |         |   |    |    |   |   |    |    |
| 18                                       |  |   |    |    |                |   |    |    |                |   |    |    |                |   |    |    |                |   |    |    |                |   |    |    |         |   |    |    |   |   |    |    |
| 19                                       |  |   |    |    |                |   |    |    |                |   |    |    |                |   |    |    |                |   |    |    |                |   |    |    |         |   |    |    |   |   |    |    |
| 20                                       |  |   |    |    |                |   |    |    |                |   |    |    |                |   |    |    |                |   |    |    |                |   |    |    |         |   |    |    |   |   |    |    |
| 21                                       |  |   |    |    |                |   |    |    |                |   |    |    |                |   |    |    |                |   |    |    |                |   |    |    |         |   |    |    |   |   |    |    |
| 22                                       |  |   |    |    |                |   |    |    |                |   |    |    |                |   |    |    |                |   |    |    |                |   |    |    |         |   |    |    |   |   |    |    |
| 23                                       |  |   |    |    |                |   |    |    |                |   |    |    |                |   |    |    |                |   |    |    |                |   |    |    |         |   |    |    |   |   |    |    |
| 24                                       |  |   |    |    |                |   |    |    |                |   |    |    |                |   |    |    |                |   |    |    |                |   |    |    |         |   |    |    |   |   |    |    |
| *  |  |   |    |    |                |   |    |    |                |   |    |    |                |   |    |    |                |   |    |    |                |   |    |    |         |   |    |    |   |   |    |    |

# 7 Programming Tables

| Outside line no. | [414] Outside (CO) Line Mode — Day |     |           |    |    |   | [415] Outside (CO) Line Mode — Night |     |           |    |    |   | [416] Outside (CO) Line Mode — Lunch |     |           |    |    |   |
|------------------|------------------------------------|-----|-----------|----|----|---|--------------------------------------|-----|-----------|----|----|---|--------------------------------------|-----|-----------|----|----|---|
|                  | N                                  | DIL | Extn. no. | D1 | D2 | U | N                                    | DIL | Extn. no. | D1 | D2 | U | N                                    | DIL | Extn. no. | D1 | D2 | U |
| Default: All     | ✓                                  |     |           |    |    |   | ✓                                    |     |           |    |    |   | ✓                                    |     |           |    |    |   |
| 1                |                                    |     |           |    |    |   |                                      |     |           |    |    |   |                                      |     |           |    |    |   |
| 2                |                                    |     |           |    |    |   |                                      |     |           |    |    |   |                                      |     |           |    |    |   |
| 3                |                                    |     |           |    |    |   |                                      |     |           |    |    |   |                                      |     |           |    |    |   |
| 4                |                                    |     |           |    |    |   |                                      |     |           |    |    |   |                                      |     |           |    |    |   |
| 5                |                                    |     |           |    |    |   |                                      |     |           |    |    |   |                                      |     |           |    |    |   |
| 6                |                                    |     |           |    |    |   |                                      |     |           |    |    |   |                                      |     |           |    |    |   |
| *                |                                    |     |           |    |    |   |                                      |     |           |    |    |   |                                      |     |           |    |    |   |

| Outside line no. | [417] Pause Time    |     |     |     | [418] Flash Time         |     |     |     |     |     |      |  |
|------------------|---------------------|-----|-----|-----|--------------------------|-----|-----|-----|-----|-----|------|--|
|                  | Selection (seconds) |     |     |     | Selection (milliseconds) |     |     |     |     |     |      |  |
|                  | 1.5                 | 2.5 | 3.5 | 4.5 | 80                       | 100 | 160 | 300 | 600 | 900 | 1200 |  |
| Default: All     | ✓                   |     |     |     |                          |     |     |     | ✓   |     |      |  |
| 1                |                     |     |     |     |                          |     |     |     |     |     |      |  |
| 2                |                     |     |     |     |                          |     |     |     |     |     |      |  |
| 3                |                     |     |     |     |                          |     |     |     |     |     |      |  |
| 4                |                     |     |     |     |                          |     |     |     |     |     |      |  |
| 5                |                     |     |     |     |                          |     |     |     |     |     |      |  |
| 6                |                     |     |     |     |                          |     |     |     |     |     |      |  |
| *                |                     |     |     |     |                          |     |     |     |     |     |      |  |

| Outside line no. | [419] Automatic Designated Outside (CO) Line Access |         | [420] Calling Party Control (CPC) Signal              | [421] CPC Detection for Outgoing Calls |         |
|------------------|---|---------|---|--|---------|
|                  | Selection   |         | Selection: 00 (Disable), 06 (62 msec)···75 (614 msec) | Selection                              |         |
|                  | Enable  | Disable |   | Enable                                 | Disable |
| Default: All     | ✓   |         | 42 (350 milliseconds)                                 |  | ✓       |
| 1                |   |         |   |  |         |
| 2                |   |         |   |  |         |
| 3                |   |         |   |  |         |
| 4                |   |         |   |  |         |
| 5                |   |         |   |  |         |
| 6                |   |         |   |  |         |
| *                |   |         |   |  |         |

# 7 *Programming Tables*

|                  | [422] Disconnect Time |     |     | [423] Outside (CO) Line Ringing Pattern Selection |        |        | [424] Reverse (Polarity) Circuit Assignment |         |
|------------------|-----------------------|-----|-----|---|--------|--------|---|---------|
|                  | Selection (seconds)   |     |     | Selection   |        |        | Selection                                   |         |
| Outside line no. | 0.5                   | 1.5 | 4.0 | Single  | Double | Triple | Enable                                      | Disable |
| Default: All     |                       | ✓   |     | ✓   |        |        |   | ✓       |
| 1                |                       |     |     |   |        |        |   |         |
| 2                |                       |     |     |   |        |        |   |         |
| 3                |                       |     |     |   |        |        |   |         |
| 4                |                       |     |     |   |        |        |   |         |
| 5                |                       |     |     |   |        |        |   |         |
| 6                |                       |     |     |   |        |        |   |         |
| *                |                       |     |     |   |        |        |   |         |

| [500] DISA Incoming Dialing Mode Selection |            |         |
|--|------------|---------|
| Selection                                  | Without AA | With AA |
| Default                                    | ✓          |         |
| Change                                     |            |         |

| [501] DISA Built-in Auto Attendant |                                    |                                  |
|------------------------------------|------------------------------------|----------------------------------|
| Auto attendant no.                 | Selection                          |                                  |
|                                    | Jack: Extension jack no. (01...24) | GRP: Extension group no. (1...8) |
| Default                            | All: Not stored                    |                                  |
| 0                                  |                                    |                                  |
| 1                                  |                                    |                                  |
| 2                                  |                                    |                                  |
| 3                                  |                                    |                                  |
| 4                                  |                                    |                                  |
| 5                                  |                                    |                                  |
| 6                                  |                                    |                                  |
| 7                                  |                                    |                                  |
| 8                                  |                                    |                                  |
| 9                                  |                                    |                                  |

# 7 Programming Tables

|           | [502]<br>OGM MODE Selection |        |        |        |        | [503]<br>FAX Connection                |  |
|-----------|-----------------------------|--------|--------|--------|--------|--|--|
| Selection | MODE 1                      | MODE 2 | MODE 3 | MODE 4 | MODE 5 | Extension jack no. (01...24) / Disable |  |
| Default   | ✓                           |        |        |        |        | Disable (Not assigned)                 |  |
| Change    |                             |        |        |        |        |  |  |

|           | [504]<br>DISA Delayed Answer Time |       |       |        | [505]<br>DISA Waiting Time after OGM |       |        |        |
|-----------|-----------------------------------|-------|-------|--------|--------------------------------------|-------|--------|--------|
| Selection | 0 sec                             | 3 sec | 6 sec | 12 sec | 0 sec                                | 5 sec | 10 sec | 15 sec |
| Default   |                                   | ✓     |       |        |                                      | ✓     |        |        |
| Change    |                                   |       |       |        |                                      |       |        |        |

|           | [506]<br>DISA Busy Mode |              |        | [507] DISA<br>Intercept Mode |            | [508]<br>DISA Ringing Time before Intercept |        |        |        |        |         |
|-----------|-------------------------|--------------|--------|------------------------------|------------|---|--------|--------|--------|--------|---------|
| Selection | Disconnect              | Call Waiting | DISA 2 | Intercept                    | Disconnect | 10 sec                                      | 20 sec | 30 sec | 40 sec | 60 sec | 120 sec |
| Default   | ✓                       |              |        | ✓                            |            |   | ✓      |        |        |        |         |
| Change    |                         |              |        |                              |            |   |        |        |        |        |         |

|           | [509]<br>DISA Ringing Time after Intercept |        |        |        |        |         | [510]<br>DISA No Dial Mode |            |           |            |
|-----------|--|--------|--------|--------|--------|---------|----------------------------|------------|-----------|------------|
| Selection | 10 sec                                     | 20 sec | 30 sec | 40 sec | 60 sec | 120 sec | DISA 1                     |            | DISA 2    |            |
|           |  |        |        |        |        |         | Intercept                  | Disconnect | Intercept | Disconnect |
| Default   |  | ✓      |        |        |        |         | ✓                          |            | ✓         |            |
| Change    |  |        |        |        |        |         |                            |            |           |            |

|           | [511]<br>DISA Security Type |     |      | [512]<br>DISA Security Codes |         |         |         | [513]<br>Cyclic Tone Detection |         |         |         |
|-----------|-----------------------------|-----|------|------------------------------|---------|---------|---------|--------------------------------|---------|---------|---------|
| Selection | Trunk                       | All | None | 0...9, 4 digit               |         |         |         | Disable                        | 2 Times | 3 Times | 4 Times |
| Default   | ✓                           |     |      | All codes = 0000             |         |         |         |                                |         |         | ✓       |
| Change    |                             |     |      | CODE=01                      | CODE=02 | CODE=03 | CODE=04 |                                |         |         |         |

|           | [514] FAX<br>Tone Detection |         | [515] Intercept Time<br>for Internal DISA |       |       | [517]<br>DISA AA Wait Time |       |       |       |       |
|-----------|-----------------------------|---------|---|-------|-------|----------------------------|-------|-------|-------|-------|
| Selection | 1 Time                      | 2 Times | 3 sec                                     | 6 sec | 9 sec | 1 sec                      | 2 sec | 3 sec | 4 sec | 5 sec |
| Default   | ✓                           |         | ✓   |       |       |                            | ✓     |       |       |       |
| Change    |                             |         |   |       |       |                            |       |       |       |       |

# 7 Programming Tables

| [516] DISA Incoming Assignment |           |         |                    |           |         |
|--------------------------------|-----------|---------|--------------------|-----------|---------|
| Extension jack no.             | Selection |         | Extension jack no. | Selection |         |
|                                | Enable    | Disable |                    | Enable    | Disable |
| Default: All                   | ✓         |         | 13                 |           |         |
| 01                             |           |         | 14                 |           |         |
| 02                             |           |         | 15                 |           |         |
| 03                             |           |         | 16                 |           |         |
| 04                             |           |         | 17                 |           |         |
| 05                             |           |         | 18                 |           |         |
| 06                             |           |         | 19                 |           |         |
| 07                             |           |         | 20                 |           |         |
| 08                             |           |         | 21                 |           |         |
| 09                             |           |         | 22                 |           |         |
| 10                             |           |         | 23                 |           |         |
| 11                             |           |         | 24                 |           |         |
| 12                             |           |         |                    |           |         |

|           | [518] DISA Tone Selection after the Security Code |         | [519] DISA OGM Mute Time |       |       |       | [520] UCD Group             |
|-----------|---|---------|--------------------------|-------|-------|-------|-----------------------------|
|           | Enable  | Disable | 0 sec                    | 2 sec | 4 sec | 6 sec | Extension group no. (1...8) |
| Selection |   |         |                          |       |       |       |                             |
| Default   | ✓   |         | ✓                        |       |       |       | 1                           |
| Change    |   |         |                          |       |       |       |                             |

|           | [521] UCD Busy Waiting Time | [522] UCD OGM Message Interval Time |       |         |       | [523] UCD Busy Mode |            |
|-----------|-----------------------------|-------------------------------------|-------|---------|-------|---------------------|------------|
|           | 01...32 minutes             | 30 sec                              | 1 min | 1.5 min | 2 min | Intercept           | Disconnect |
| Selection |                             |                                     |       |         |       |                     |            |
| Default   | 10 minutes                  |                                     | ✓     |         |       | ✓                   |            |
| Change    |                             |                                     |       |         |       |                     |            |

|           | [524] UCD Intercept Mode |            | [525] UCD Ringing Time before Intercept |        |        |        |        |         |
|-----------|--------------------------|------------|---|--------|--------|--------|--------|---------|
|           | Intercept                | Disconnect | 10 sec                                  | 20 sec | 30 sec | 40 sec | 60 sec | 120 sec |
| Selection |                          |            |   |        |        |        |        |         |
| Default   | ✓                        |            |   | ✓      |        |        |        |         |
| Change    |                          |            |   |        |        |        |        |         |

| [526] UCD Ringing Time after Intercept |        |        |        |        |        |         |
|--|--------|--------|--------|--------|--------|---------|
| Selection                              | 10 sec | 20 sec | 30 sec | 40 sec | 60 sec | 120 sec |
| Default                                |        | ✓      |        |        |        |         |
| Change                                 |        |        |        |        |        |         |

# 7 *Programming Tables*

| Extension<br>jack no. | [601] TRS – Class of Service<br>Assignment — Day |   |   |   |   | [602] TRS – Class of Service<br>Assignment — Night |   |   |   |   | [603] TRS – Class of Service<br>Assignment — Lunch |   |   |   |   |
|-----------------------|--|---|---|---|---|--|---|---|---|---|--|---|---|---|---|
|                       | COS no. (1...5)                                  |   |   |   |   | COS no. (1...5)                                    |   |   |   |   | COS no. (1...5)                                    |   |   |   |   |
|                       | 1  | 2 | 3 | 4 | 5 | 1  | 2 | 3 | 4 | 5 | 1  | 2 | 3 | 4 | 5 |
| Default: All          | ✓  |   |   |   |   | ✓  |   |   |   |   | ✓  |   |   |   |   |
| 01                    |  |   |   |   |   |  |   |   |   |   |  |   |   |   |   |
| 02                    |  |   |   |   |   |  |   |   |   |   |  |   |   |   |   |
| 03                    |  |   |   |   |   |  |   |   |   |   |  |   |   |   |   |
| 04                    |  |   |   |   |   |  |   |   |   |   |  |   |   |   |   |
| 05                    |  |   |   |   |   |  |   |   |   |   |  |   |   |   |   |
| 06                    |  |   |   |   |   |  |   |   |   |   |  |   |   |   |   |
| 07                    |  |   |   |   |   |  |   |   |   |   |  |   |   |   |   |
| 08                    |  |   |   |   |   |  |   |   |   |   |  |   |   |   |   |
| 09                    |  |   |   |   |   |  |   |   |   |   |  |   |   |   |   |
| 10                    |  |   |   |   |   |  |   |   |   |   |  |   |   |   |   |
| 11                    |  |   |   |   |   |  |   |   |   |   |  |   |   |   |   |
| 12                    |  |   |   |   |   |  |   |   |   |   |  |   |   |   |   |
| 13                    |  |   |   |   |   |  |   |   |   |   |  |   |   |   |   |
| 14                    |  |   |   |   |   |  |   |   |   |   |  |   |   |   |   |
| 15                    |  |   |   |   |   |  |   |   |   |   |  |   |   |   |   |
| 16                    |  |   |   |   |   |  |   |   |   |   |  |   |   |   |   |
| 17                    |  |   |   |   |   |  |   |   |   |   |  |   |   |   |   |
| 18                    |  |   |   |   |   |  |   |   |   |   |  |   |   |   |   |
| 19                    |  |   |   |   |   |  |   |   |   |   |  |   |   |   |   |
| 20                    |  |   |   |   |   |  |   |   |   |   |  |   |   |   |   |
| 21                    |  |   |   |   |   |  |   |   |   |   |  |   |   |   |   |
| 22                    |  |   |   |   |   |  |   |   |   |   |  |   |   |   |   |
| 23                    |  |   |   |   |   |  |   |   |   |   |  |   |   |   |   |
| 24                    |  |   |   |   |   |  |   |   |   |   |  |   |   |   |   |
| *                     |  |   |   |   |   |  |   |   |   |   |  |   |   |   |   |

# 7 *Programming Tables*

| Extension<br>jack no. | [605]<br>Account Code Entry Mode |        |            |             | [606] Call Transfer to<br>an Outside (CO) Line |         | [607] Call Forwarding<br>to an Outside (CO) Line |         |
|-----------------------|----------------------------------|--------|------------|-------------|--|---------|--|---------|
|                       | Selection                        |        |            |             | Selection                                      |         | Selection  |         |
|                       | Option                           | Forced | Verify-All | Verify-Toll | Enable   | Disable | Enable   | Disable |
| Default: All          | ✓                                |        |            |             |  | ✓       |  | ✓       |
| 01                    |                                  |        |            |             |  |         |  |         |
| 02                    |                                  |        |            |             |  |         |  |         |
| 03                    |                                  |        |            |             |  |         |  |         |
| 04                    |                                  |        |            |             |  |         |  |         |
| 05                    |                                  |        |            |             |  |         |  |         |
| 06                    |                                  |        |            |             |  |         |  |         |
| 07                    |                                  |        |            |             |  |         |  |         |
| 08                    |                                  |        |            |             |  |         |  |         |
| 09                    |                                  |        |            |             |  |         |  |         |
| 10                    |                                  |        |            |             |  |         |  |         |
| 11                    |                                  |        |            |             |  |         |  |         |
| 12                    |                                  |        |            |             |  |         |  |         |
| 13                    |                                  |        |            |             |  |         |  |         |
| 14                    |                                  |        |            |             |  |         |  |         |
| 15                    |                                  |        |            |             |  |         |  |         |
| 16                    |                                  |        |            |             |  |         |  |         |
| 17                    |                                  |        |            |             |  |         |  |         |
| 18                    |                                  |        |            |             |  |         |  |         |
| 19                    |                                  |        |            |             |  |         |  |         |
| 20                    |                                  |        |            |             |  |         |  |         |
| 21                    |                                  |        |            |             |  |         |  |         |
| 22                    |                                  |        |            |             |  |         |  |         |
| 23                    |                                  |        |            |             |  |         |  |         |
| 24                    |                                  |        |            |             |  |         |  |         |
| *                     |                                  |        |            |             |  |         |  |         |

# 7

## Programming Tables

| Extension<br>jack no. | [608] Executive<br>Busy Override |         | [609] Do not<br>Disturb Override |         | [610] Paralleled<br>Telephone Connection |         | [611]<br>TAM Extension |         |
|-----------------------|----------------------------------|---------|----------------------------------|---------|--|---------|------------------------|---------|
|                       | Selection                        |         | Selection                        |         | Selection                                |         | Selection              |         |
|                       | Enable                           | Disable | Enable                           | Disable | Enable                                   | Disable | Enable                 | Disable |
| Default: All          |                                  | ✓       |                                  | ✓       |  | ✓       |                        | ✓       |
| 01                    |                                  |         |                                  |         |  |         |                        |         |
| 02                    |                                  |         |                                  |         |  |         |                        |         |
| 03                    |                                  |         |                                  |         |  |         |                        |         |
| 04                    |                                  |         |                                  |         |  |         |                        |         |
| 05                    |                                  |         |                                  |         |  |         |                        |         |
| 06                    |                                  |         |                                  |         |  |         |                        |         |
| 07                    |                                  |         |                                  |         |  |         |                        |         |
| 08                    |                                  |         |                                  |         |  |         |                        |         |
| 09                    |                                  |         |                                  |         |  |         |                        |         |
| 10                    |                                  |         |                                  |         |  |         |                        |         |
| 11                    |                                  |         |                                  |         |  |         |                        |         |
| 12                    |                                  |         |                                  |         |  |         |                        |         |
| 13                    |                                  |         |                                  |         |  |         |                        |         |
| 14                    |                                  |         |                                  |         |  |         |                        |         |
| 15                    |                                  |         |                                  |         |  |         |                        |         |
| 16                    |                                  |         |                                  |         |  |         |                        |         |
| 17                    |                                  |         |                                  |         |  |         |                        |         |
| 18                    |                                  |         |                                  |         |  |         |                        |         |
| 19                    |                                  |         |                                  |         |  |         |                        |         |
| 20                    |                                  |         |                                  |         |  |         |                        |         |
| 21                    |                                  |         |                                  |         |  |         |                        |         |
| 22                    |                                  |         |                                  |         |  |         |                        |         |
| 23                    |                                  |         |                                  |         |  |         |                        |         |
| 24                    |                                  |         |                                  |         |  |         |                        |         |
| *                     |                                  |         |                                  |         |  |         |                        |         |

# 7 *Programming Tables*

| Extension<br>jack no. | [612]<br>Room Monitor<br>Assignment |         | [613] Outside (CO)<br>Line Duration Time<br>Limit Selection |         | [614]<br>Internal Pulse<br>Detection |         | [615]<br>LCD Language<br>Assignment |         |            |         |
|-----------------------|-------------------------------------|---------|---|---------|--------------------------------------|---------|-------------------------------------|---------|------------|---------|
|                       | Selection                           |         | Selection   |         | Selection                            |         | Selection                           |         |            |         |
|                       | Enable                              | Disable | Enable  | Disable | Enable                               | Disable | English                             | Spanish | Portuguese | Russian |
| Default: All          |                                     | ✓       |   | ✓       | ✓                                    |         | ✓                                   |         |            |         |
| 01                    |                                     |         |   |         |                                      |         |                                     |         |            |         |
| 02                    |                                     |         |   |         |                                      |         |                                     |         |            |         |
| 03                    |                                     |         |   |         |                                      |         |                                     |         |            |         |
| 04                    |                                     |         |   |         |                                      |         |                                     |         |            |         |
| 05                    |                                     |         |   |         |                                      |         |                                     |         |            |         |
| 06                    |                                     |         |   |         |                                      |         |                                     |         |            |         |
| 07                    |                                     |         |   |         |                                      |         |                                     |         |            |         |
| 08                    |                                     |         |   |         |                                      |         |                                     |         |            |         |
| 09                    |                                     |         |   |         |                                      |         |                                     |         |            |         |
| 10                    |                                     |         |   |         |                                      |         |                                     |         |            |         |
| 11                    |                                     |         |   |         |                                      |         |                                     |         |            |         |
| 12                    |                                     |         |   |         |                                      |         |                                     |         |            |         |
| 13                    |                                     |         |   |         |                                      |         |                                     |         |            |         |
| 14                    |                                     |         |   |         |                                      |         |                                     |         |            |         |
| 15                    |                                     |         |   |         |                                      |         |                                     |         |            |         |
| 16                    |                                     |         |   |         |                                      |         |                                     |         |            |         |
| 17                    |                                     |         |   |         |                                      |         |                                     |         |            |         |
| 18                    |                                     |         |   |         |                                      |         |                                     |         |            |         |
| 19                    |                                     |         |   |         |                                      |         |                                     |         |            |         |
| 20                    |                                     |         |   |         |                                      |         |                                     |         |            |         |
| 21                    |                                     |         |   |         |                                      |         |                                     |         |            |         |
| 22                    |                                     |         |   |         |                                      |         |                                     |         |            |         |
| 23                    |                                     |         |   |         |                                      |         |                                     |         |            |         |
| 24                    |                                     |         |   |         |                                      |         |                                     |         |            |         |
| *                     |                                     |         |   |         |                                      |         |                                     |         |            |         |

# 7 *Programming Tables*

|                    | [700] Doorphone Ringing Assignment — Day     |   |   |   | [701] Doorphone Ringing Assignment — Night |   |   |   | [702] Doorphone Ringing Assignment — Lunch |   |   |   |   |   |   |   |
|--------------------|--|---|---|---|--|---|---|---|--|---|---|---|---|---|---|---|
|                    | 1...4: Doorphone no., E: Enable / D: Disable |   |   |   |  |   |   |   |  |   |   |   |   |   |   |   |
| Extension jack no. | 1  |   | 2 |   | 3  |   | 4 |   | 1  |   | 2 |   | 3 |   | 4 |   |
|                    | E  | D | E | D | E  | D | E | D | E  | D | E | D | E | D | E | D |
| Default: All       | ✓  |   | ✓ |   | ✓  |   | ✓ |   | ✓  |   | ✓ |   | ✓ |   | ✓ |   |
| 01                 |  |   |   |   |  |   |   |   |  |   |   |   |   |   |   |   |
| 02                 |  |   |   |   |  |   |   |   |  |   |   |   |   |   |   |   |
| 03                 |  |   |   |   |  |   |   |   |  |   |   |   |   |   |   |   |
| 04                 |  |   |   |   |  |   |   |   |  |   |   |   |   |   |   |   |
| 05                 |  |   |   |   |  |   |   |   |  |   |   |   |   |   |   |   |
| 06                 |  |   |   |   |  |   |   |   |  |   |   |   |   |   |   |   |
| 07                 |  |   |   |   |  |   |   |   |  |   |   |   |   |   |   |   |
| 08                 |  |   |   |   |  |   |   |   |  |   |   |   |   |   |   |   |
| 09                 |  |   |   |   |  |   |   |   |  |   |   |   |   |   |   |   |
| 10                 |  |   |   |   |  |   |   |   |  |   |   |   |   |   |   |   |
| 11                 |  |   |   |   |  |   |   |   |  |   |   |   |   |   |   |   |
| 12                 |  |   |   |   |  |   |   |   |  |   |   |   |   |   |   |   |
| 13                 |  |   |   |   |  |   |   |   |  |   |   |   |   |   |   |   |
| 14                 |  |   |   |   |  |   |   |   |  |   |   |   |   |   |   |   |
| 15                 |  |   |   |   |  |   |   |   |  |   |   |   |   |   |   |   |
| 16                 |  |   |   |   |  |   |   |   |  |   |   |   |   |   |   |   |
| 17                 |  |   |   |   |  |   |   |   |  |   |   |   |   |   |   |   |
| 18                 |  |   |   |   |  |   |   |   |  |   |   |   |   |   |   |   |
| 19                 |  |   |   |   |  |   |   |   |  |   |   |   |   |   |   |   |
| 20                 |  |   |   |   |  |   |   |   |  |   |   |   |   |   |   |   |
| 21                 |  |   |   |   |  |   |   |   |  |   |   |   |   |   |   |   |
| 22                 |  |   |   |   |  |   |   |   |  |   |   |   |   |   |   |   |
| 23                 |  |   |   |   |  |   |   |   |  |   |   |   |   |   |   |   |
| 24                 |  |   |   |   |  |   |   |   |  |   |   |   |   |   |   |   |
| *                  |  |   |   |   |  |   |   |   |  |   |   |   |   |   |   |   |

# 7 Programming Tables

|                    | [703] Door Opener Assignment — Day             |   |   |   | [704] Door Opener Assignment — Night |   |   |   | [705] Door Opener Assignment — Lunch |   |   |   |   |   |   |   |
|--------------------|--|---|---|---|--------------------------------------|---|---|---|--------------------------------------|---|---|---|---|---|---|---|
|                    | 1...4: Door opener no., E: Enable / D: Disable |   |   |   |                                      |   |   |   |                                      |   |   |   |   |   |   |   |
| Extension jack no. | 1  |   | 2 |   | 3                                    |   | 4 |   | 1                                    |   | 2 |   | 3 |   | 4 |   |
|                    | E  | D | E | D | E                                    | D | E | D | E                                    | D | E | D | E | D | E | D |
| Default: All       |  | ✓ |   | ✓ |                                      | ✓ |   | ✓ |                                      | ✓ |   | ✓ |   | ✓ |   | ✓ |
| 01                 |  |   |   |   |                                      |   |   |   |                                      |   |   |   |   |   |   |   |
| 02                 |  |   |   |   |                                      |   |   |   |                                      |   |   |   |   |   |   |   |
| 03                 |  |   |   |   |                                      |   |   |   |                                      |   |   |   |   |   |   |   |
| 04                 |  |   |   |   |                                      |   |   |   |                                      |   |   |   |   |   |   |   |
| 05                 |  |   |   |   |                                      |   |   |   |                                      |   |   |   |   |   |   |   |
| 06                 |  |   |   |   |                                      |   |   |   |                                      |   |   |   |   |   |   |   |
| 07                 |  |   |   |   |                                      |   |   |   |                                      |   |   |   |   |   |   |   |
| 08                 |  |   |   |   |                                      |   |   |   |                                      |   |   |   |   |   |   |   |
| 09                 |  |   |   |   |                                      |   |   |   |                                      |   |   |   |   |   |   |   |
| 10                 |  |   |   |   |                                      |   |   |   |                                      |   |   |   |   |   |   |   |
| 11                 |  |   |   |   |                                      |   |   |   |                                      |   |   |   |   |   |   |   |
| 12                 |  |   |   |   |                                      |   |   |   |                                      |   |   |   |   |   |   |   |
| 13                 |  |   |   |   |                                      |   |   |   |                                      |   |   |   |   |   |   |   |
| 14                 |  |   |   |   |                                      |   |   |   |                                      |   |   |   |   |   |   |   |
| 15                 |  |   |   |   |                                      |   |   |   |                                      |   |   |   |   |   |   |   |
| 16                 |  |   |   |   |                                      |   |   |   |                                      |   |   |   |   |   |   |   |
| 17                 |  |   |   |   |                                      |   |   |   |                                      |   |   |   |   |   |   |   |
| 18                 |  |   |   |   |                                      |   |   |   |                                      |   |   |   |   |   |   |   |
| 19                 |  |   |   |   |                                      |   |   |   |                                      |   |   |   |   |   |   |   |
| 20                 |  |   |   |   |                                      |   |   |   |                                      |   |   |   |   |   |   |   |
| 21                 |  |   |   |   |                                      |   |   |   |                                      |   |   |   |   |   |   |   |
| 22                 |  |   |   |   |                                      |   |   |   |                                      |   |   |   |   |   |   |   |
| 23                 |  |   |   |   |                                      |   |   |   |                                      |   |   |   |   |   |   |   |
| 24                 |  |   |   |   |                                      |   |   |   |                                      |   |   |   |   |   |   |   |
| *                  |  |   |   |   |                                      |   |   |   |                                      |   |   |   |   |   |   |   |

|               | [706] Doorphone Ringing / Tone Pattern Selection |        |        |          | [707] Doorphone Access Tone Selection |         | [708] Doorphone Ringing Time |        |
|---------------|--|--------|--------|----------|---------------------------------------|---------|------------------------------|--------|
|               | Selection  |        |        |          | Selection                             |         | Selection                    |        |
| Doorphone no. | Single   | Double | Triple | S-Double | Enable                                | Disable | 15 sec                       | 30 sec |
| Default: All  |  |        | ✓      |          | ✓                                     |         | ✓                            |        |
| 1             |  |        |        |          |                                       |         |                              |        |
| 2             |  |        |        |          |                                       |         |                              |        |
| 3             |  |        |        |          |                                       |         |                              |        |
| 4             |  |        |        |          |                                       |         |                              |        |
| *             |  |        |        |          |                                       |         |                              |        |

# 7 Programming Tables

| [709] Door Opener Time |           |       |       |       |       |       |       |       |
|------------------------|-----------|-------|-------|-------|-------|-------|-------|-------|
| Door opener no.        | Selection |       |       |       |       |       |       |       |
|                        | 1 sec     | 2 sec | 3 sec | 4 sec | 5 sec | 6 sec | 7 sec | 8 sec |
| Default: All           |           |       |       |       | ✓     |       |       |       |
| 1                      |           |       |       |       |       |       |       |       |
| 2                      |           |       |       |       |       |       |       |       |
| 3                      |           |       |       |       |       |       |       |       |
| 4                      |           |       |       |       |       |       |       |       |
| *                      |           |       |       |       |       |       |       |       |

| [800] SMDR RS-232C Communication Parameters |               |    |           |     |     |      |      |      |      |             |   |            |       |      |     |      |          |   |
|---|---------------|----|-----------|-----|-----|------|------|------|------|-------------|---|------------|-------|------|-----|------|----------|---|
| Selection                                   | New line code |    | Baud rate |     |     |      |      |      |      | Word length |   | Parity bit |       |      |     |      | Stop bit |   |
|   | CR+LF         | CR | 150       | 300 | 600 | 1200 | 2400 | 4800 | 9600 | 7           | 8 | Mark       | Space | Even | Odd | None | 1        | 2 |
| Default                                     | ✓             |    |           |     |     |      |      |      | ✓    | ✓           | ✓ |            |       |      |     |      | ✓        |   |
| Change                                      |               |    |           |     |     |      |      |      |      |             |   |            |       |      |     |      |          |   |

| [801] SMDR Parameter      |         |           |
|---------------------------|---------|-----------|
|                           | Default | Selection |
| Page length (4...99)      | 66      |           |
| Skip perforation (0...95) | 0       |           |

| [802] Incoming/Outgoing Call Selection for Printing |      |         |           |
|---|------|---------|-----------|
|   |      | Default | Selection |
| Incoming calls                                      | On   | ✓       |           |
|   | Off  |         |           |
| Outgoing calls                                      | On   | ✓       |           |
|   | Off  |         |           |
|   | Toll |         |           |

|         | [803] Secret Speed Dialing / One-Touch Dialing Printing |          | [805] SMDR Account Code Selection |       |
|---------|---|----------|-----------------------------------|-------|
|         | No Printing   | Printing | CODE                              | INDEX |
| Default | ✓   |          | ✓                                 |       |
| Change  |   |          |                                   |       |

# *Memo*

---

# *Memo*

---

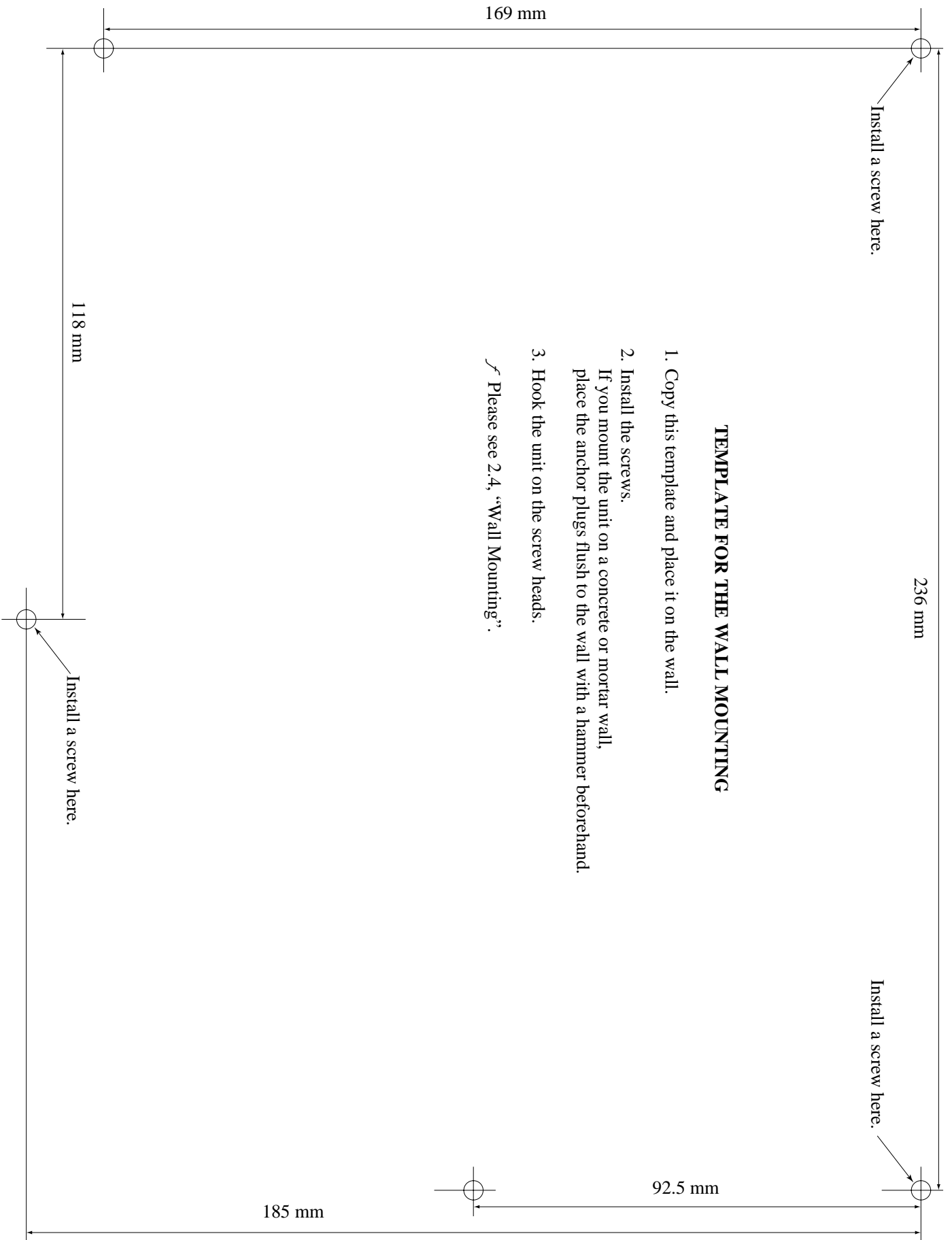

236 mm

Install a screw here.

Install a screw here.

### TEMPLATE FOR THE WALL MOUNTING

1. Copy this template and place it on the wall.
  2. Install the screws.  
If you mount the unit on a concrete or mortar wall, place the anchor plugs flush to the wall with a hammer beforehand.
  3. Hook the unit on the screw heads.
- f* Please see 2.4, "Wall Mounting".

92.5 mm

169 mm

185 mm

118 mm

Install a screw here.

## NOTE

You can identify the data of manufacturing by serial number which is marked on the right side of the main unit.

Serial number : X X XXXXXXXXXX

First digit : year (last digit of the year in number)  
8-1998, 9-1999, 0-2000

Second digit : month (in alphabetical)  
A-January, B-February, ... L-December

**Matsushita Electric Industrial Co., Ltd.**  
Central P. O. Box 288, Osaka 530-91, Japan

Printed in Japan

**PSQX1574ZA** KF0898CM0