

DubUgcbJWHY`Yd\ cbY`GngHya g



# Panasonic KX-TA824

www.voicesonic.com

Phone: 877-289-2829



## Advanced Hybrid System Programming Manual

Model No. **KX-TA824**

Panasonic KX-TA824, KXTA824, KX TA824, KX-TA82483, KX-TA82481, KX-TA82470, KX-TA82461, KX-TA82491, KX-TA82492, KX-TA82493



Thank you for purchasing a Panasonic Advanced Hybrid System.  
Please read this manual carefully before using this product and save this manual for future use.

---

# Introduction

## About this Programming Manual

The Programming Manual is designed to serve as an overall system programming reference for the Panasonic Advanced Hybrid System.

It explains how to program this PBX using Panasonic proprietary telephones (PTs) or the KX-TA Maintenance Console software.

The Programming Manual is divided into the following sections:

### Section 1, Overview

Provides an overview of methods of programming the PBX, and information about password security.

### Section 2, PT Programming

Serves as reference operating instructions when using a display PT to program the PBX.

### Section 3, PC Programming—Introduction

Serves as reference operating instructions when using the KX-TA Maintenance Console software to program the PBX.

### Section 4, PC Programming—Opening Screen

Describes the options available when starting Maintenance Console.

### Section 5, PC Programming—File

Explains the File menu, which lets you work with system data files, and view programming items.

### Section 6, PC Programming—Connect

Describes the Connect menu, which offers options for connecting a PC to the PBX.

### Section 7, PC Programming—View

Describes the View menu, which allows you to customize the operation of Maintenance Console.

### Section 8, PC Programming—Utility

Describes the Utility menu, which contains options for performing system maintenance on the PBX.

### Section 9, PC Programming—System Data Setting

Describes the options available on each setting screen of the Maintenance Console.

## References Found in the Programming Manual

### Installation Manual References

The Installation Manual provides instructions detailing the installation and maintenance of the PBX. Sections from the Installation Manual are listed throughout the Programming Manual for your reference.

### Programming Manual References

Related sections of the Programming Manual are listed for your reference.

---

## Feature Manual References

The Feature Manual explains what the PBX can do, as well as how to obtain the most of its many features and facilities. Sections from the Feature Manual are listed throughout the Programming Manual for your reference.

## Operating Manual References

The Operating Manual describes how users can access commonly used PBX features and functions with their PTs, single line telephones (SLTs), and Direct Station Selection (DSS) Consoles. Sections from the Operating Manual are listed throughout the Programming Manual for your reference.

## Links to Other Pages and Manuals

If you are viewing this Programming Manual with a PC, certain items are linked to different sections of the Programming Manual and other PBX manuals. Click on a link to jump to that section.

Linked items include:

- [Installation Manual References](#)
- [Programming Manual References](#)
- [Feature Manual References](#)
- [Operating Manual References](#)

## Trademarks

- Microsoft and Windows are either registered trademarks or trademarks of Microsoft Corporation in the United States and/or other countries.
- Celeron and Intel are trademarks or registered trademarks of Intel Corporation or its subsidiaries in the United States and other countries.
- All other trademarks identified herein are the property of their respective owners.
- Screen shots reprinted with permission from Microsoft Corporation.

---

## List of Abbreviations

<b>A</b>	AA	→	Automated Attendant
	APT	→	Analog Proprietary Telephone
<b>B</b>	BGM	→	Background Music
	BV	→	Built-in Voice Message
<b>C</b>	CO	→	Outside (CO) Line
	COS	→	Class of Service
	CPC	→	Calling Party Control
<b>D</b>	DIL	→	Direct In Line
	DISA	→	Direct Inward System Access
	DND	→	Do Not Disturb
	DSS	→	Direct Station Selection
	DTMF	→	Dual Tone Multi-Frequency
<b>E</b>	EFA	→	External Feature Access
<b>G</b>	GRP	→	Group
<b>I</b>	IRNA	→	Intercept Routing—No Answer
<b>L</b>	LCS	→	Live Call Screening
<b>O</b>	OGM	→	Outgoing Message
<b>P</b>	PT	→	Proprietary Telephone
<b>S</b>	SLT	→	Single Line Telephone
	SMDR	→	Station Message Detail Recording
<b>T</b>	TAM	→	Telephone Answering Machine
	TRS	→	Toll Restriction
<b>V</b>	VM	→	Voice Mail

---

# Table of Contents

<b>1</b>	<b>Overview</b>	<b>11</b>
1.1	Introduction	12
1.1.1	Introduction	12
<b>2</b>	<b>PT Programming</b>	<b>13</b>
2.1	PT Programming—Instructions	14
2.2	PT Programming—Procedures	17
	[000] Date & Time	17
	[001] System Speed Dialing Number	18
	[002] System Password	18
	[003] DSS Console Jack Assignment	19
	[004] Console Paired Telephone	20
	[005] One-touch Transfer Using a DSS Button	20
	[006] Time Service Switching Mode	20
	[007] Time Service Start Time	21
	[008] Operator Assignment	21
	[009] Extension Number	22
	[010] LCD Time Display	22
	[011] System Speed Dialing Name	23
	[100] Hunting Group Set	23
	[101] Hunting Type	24
	[102] DTMF Integration Port	24
	[103] DTMF Integration	25
	[104] SLT Hold Mode	25
	[105] Conference Tone	25
	[106] External Pager Access Tone	25
	[107] DTMF Receiver Check	26
	[108] Flash/Recall Mode for a Locked Extension	26
	[109] CO Indicator	26
	[110] Flash/Recall Key Mode	27
	[111] Music on Hold	27
	[112] DSS Lamp Mode	27
	[115] Extension Ring Tone Pattern	27
	[117] Call Pickup Tone	28
	[118] Pulse Restriction	28
	[119] Redialing after Pulse to Tone Conversion	28
	[128] Ringback Tone Pattern	28
	[130] VM 1 APT Port	29
	[131] VM 2 APT Port	29
	[142] SLT Ring/Silence Ratio	30
	[143] SLT Ring Bell-on Time	30
	[150] SLT Caller ID Signaling Type	30
	[151] SLT Caller ID Line Access Number	31
	[152] Automatic Time Adjustment	31
	[200] Hold Recall Time	31
	[201] Transfer Recall Time	31
	[202] Call Forwarding Start Time	32
	[203] Hot Line Waiting Time	32
	[204] Call Duration Counter Start	32
	[205] CO-to-CO Line Call Duration	32
	[206] Dialing Start Time	33
	[208] Inter-digit Time	33
	[211] No Dial Disconnection	33
	[214] BV Recording Time	33
	[215] Common/Personal BV OGM Recording Time	34

[300] Carrier Exception Code .....	34
[301] TRS—System Speed Dialing Class .....	34
[302-305] TRS—COS 2-5 Denied Code.....	35
[306] TRS—Exception Code .....	35
[309] Emergency Number.....	36
[310] Account Code .....	36
[311] Automatic Pause Insertion Code .....	37
[312] TRS—Extension Lock Class .....	37
[400] CO Line Connection .....	37
[401] Dial Mode .....	38
[402] Pulse Speed .....	38
[403] Host PBX Access Code.....	39
[404] CO Line Group Number.....	39
[405-407] Flexible Outward Dialing—Day/Night/Lunch.....	40
[408-410] Flexible Ringing—Day/Night/Lunch.....	40
[411-413] Delayed Ringing—Day/Night/Lunch .....	41
[414-416] CO Line Mode—Day/Night/Lunch .....	41
[417] Pause Time .....	43
[418] Flash/Recall Time .....	43
[419] Automatic Designated Line Access .....	44
[420] CPC Signal Detection—Incoming.....	44
[421] CPC Signal Detection—Outgoing.....	45
[422] Disconnect Time.....	45
[423] CO Line Ring Tone Pattern.....	46
[435] Local Carrier-based Voice Mail Signaling.....	46
[436] Local Carrier-based Voice Mail Access Dial.....	47
[437] Extension Access to Local Carrier-based Voice Mail .....	47
[438-440] DISA IRNA to BV—Day/Night/Lunch .....	48
[500] DISA Incoming Call Dial Mode .....	48
[501] DISA Built-in AA .....	48
[503] FAX Connection.....	49
[504] DISA Delayed Answer Time .....	49
[505] DISA Wait Time after OGM .....	49
[506] DISA Busy Mode .....	50
[507] DISA Intercept Mode .....	50
[508] DISA Ring Time before Intercept.....	50
[509] DISA Ring Time after Intercept.....	51
[510] DISA No Dial Mode .....	51
[511] DISA Security Mode .....	51
[512] DISA Security Code .....	52
[513] Cyclic Tone Detection .....	53
[514] FAX Tone Detection .....	53
[515] Intercept Time for Internal DISA .....	53
[516] DISA Incoming Assignment.....	54
[517] DISA AA Wait Time .....	54
[518] DISA Tone after Security Code.....	54
[530] DISA Security Code Digits .....	55
[531] DISA Ringback Tone .....	55
[540-549] 3-level AA Assignment .....	55
[599] Clear All OGMs of DISA .....	56
[600] Extension Group.....	56
[601-603] TRS-COS—Day/Night/Lunch .....	56
[604] Extension Name .....	57
[605] Account Code Mode.....	57
[606] Call Transfer to CO Line .....	58
[607] Call Forwarding to CO Line .....	58
[608] Executive Busy Override .....	58
[609] DND Override .....	59
[610] Paralleled Telephone .....	59
[611] TAM Extension.....	59

[612] Room Monitor .....	60
[615] LCD Language .....	60
[617] Wireless PT Port Assignment .....	60
[618] Message Waiting for Another Extension .....	61
[619] SLT Message Waiting .....	61
[620] LCS Recording Mode Set .....	61
[621] BV Resource .....	62
[622] BV for Extension .....	62
[625] BV Access Code through CO Line .....	63
[626] BGM Control for APT .....	63
[627] SLT Ring Wait Time for New Call .....	64
[628] SLT Caller ID .....	64
[629] SLT Fixed Bell Pattern .....	64
[700-702] Doorphone Ringing—Day/Night/Lunch .....	65
[703-705] Door Opener—Day/Night/Lunch .....	65
[706] Doorphone Ring Tone Pattern .....	66
[707] Doorphone Access Tone .....	66
[708] Doorphone Ring Time .....	67
[709] Door Open Duration .....	67
[710] Doorphone Ring/Chime .....	67
[711] Doorphone Chime Assignment .....	68
[712] Doorphone Chime Pattern .....	68
[800] SMDR RS-232C Parameter .....	68
[801] SMDR Parameter .....	69
[802] Incoming/Outgoing Call Selection for Printing .....	70
[803] Secret Number SMDR Print Suppression .....	70
[804] System Data Dump .....	70
[805] SMDR Account Code .....	71
[806] SMDR Language .....	72
[807] BV Total Recording Time .....	72
[808] BV Card Initialization .....	72
[900] Caller ID .....	72
[901] Caller ID Area Code .....	73
[902] Caller ID Modification for Local Calls .....	73
[903] Caller ID Modification for Long-distance Calls .....	74
[904] Caller ID Log Priority .....	74
[906] Caller ID SMDR Format .....	74
[907] Caller ID SMDR Printout .....	75
[908] Call Waiting Caller ID Time .....	75
[909] Common Area Call Log Check .....	75
[913] Call Waiting Caller ID Assignment .....	76
[914] Call Waiting Caller ID CAS Receive Time .....	76
[915] Caller ID Checksum .....	77
[963] Call Forwarding Selection .....	77
[966] TRS Check after Answering .....	77
[967] TRS Check Time after Answering .....	78
[968] KX-T7700 Series Incoming Lamp Control .....	78
[998] Firmware Version .....	78
[999] System Data Clear .....	79
<b>3 PC Programming—Introduction .....</b>	<b>81</b>
<b>3.1 Introduction .....</b>	<b>82</b>
<b>3.2 PC Programming .....</b>	<b>82</b>
3.2.1 Installing and Starting KX-TA Maintenance Console .....	82
<b>3.3 Software Modes .....</b>	<b>82</b>
<b>3.4 Status Bar .....</b>	<b>84</b>
<b>3.5 Access Levels .....</b>	<b>85</b>
<b>3.6 Standard Buttons .....</b>	<b>85</b>

<b>4</b>	<b>PC Programming—Opening Screen .....</b>	<b>87</b>
4.1	Software Modes.....	88
<b>5</b>	<b>PC Programming—File.....</b>	<b>91</b>
5.1	New .....	92
5.2	Open .....	92
5.3	Close .....	92
5.4	Save.....	93
5.5	Save As .....	93
5.6	File Transfer PC to PBX .....	93
5.7	File Transfer PBX to PC .....	94
5.8	Program List.....	94
5.9	Print.....	95
5.10	Print ALL.....	95
5.11	Exit.....	96
<b>6</b>	<b>PC Programming—Connect .....</b>	<b>97</b>
6.1	Connect.....	98
6.2	Disconnect.....	101
6.3	Profile Setup .....	102
6.4	Profile Editor.....	102
<b>7</b>	<b>PC Programming—View.....</b>	<b>107</b>
7.1	Tool Bar.....	108
7.2	Programmer Code Change.....	108
7.3	Screen Customize.....	109
7.4	System Data Setting Menu .....	109
<b>8</b>	<b>PC Programming—Utility.....</b>	<b>111</b>
8.1	Firmware Upgrade.....	112
8.2	Quick Setup .....	113
8.3	System Reset.....	116
8.3.1	Normal .....	116
8.3.2	Default.....	117
8.4	System Data Clear.....	117
8.5	DISA OGM Clear .....	118
8.6	BV Card Initialization .....	118
<b>9</b>	<b>PC Programming—System Data Setting .....</b>	<b>119</b>
9.1	System [1].....	120
9.1.1	Date & Time [1-1].....	120
9.1.2	Main [1-2] .....	121
9.1.3	Numbering Plan [1-3].....	124
9.1.4	Time Service [1-4].....	125
9.1.5	Time Service [1-4] Time Setting.....	126
9.1.6	Account Codes [1-5].....	128
9.1.7	Timers [1-6].....	129
9.1.8	SMDR [1-7] .....	133
9.1.9	Carrier Exception Codes [1-8].....	138
9.1.10	Automatic Pause Insertion Codes [1-9].....	139
9.1.11	Detail [1-10].....	140

<b>9.2</b>	<b>Extension [2]</b> .....	<b>146</b>
9.2.1	Main [2-1] .....	146
9.2.2	Feature settings [2-2] .....	154
9.2.3	PT personal settings [2-3] .....	162
9.2.4	Flexible Buttons [2-4] .....	167
9.2.5	Flexible Buttons [2-4] CO buttons .....	169
9.2.6	Flexible Buttons [2-4] PF buttons .....	171
9.2.7	Flexible Buttons [2-4] Message button .....	172
9.2.8	DSS Console [2-5] .....	173
9.2.9	DSS Console [2-5] DSS buttons .....	176
9.2.10	DSS Console [2-5] PF buttons .....	178
9.2.11	Extension Group [2-6] .....	178
<b>9.3</b>	<b>CO [3]</b> .....	<b>180</b>
9.3.1	Line Mode [3-1] .....	180
9.3.2	Incoming / Outgoing [3-2] .....	181
9.3.3	Detail [3-3] .....	183
9.3.4	Local Carrier-based VM [3-4] .....	188
<b>9.4</b>	<b>System Speed Dialing [4]</b> .....	<b>190</b>
9.4.1	System Speed Dialing [4-1] .....	190
<b>9.5</b>	<b>TRS</b> .....	<b>192</b>
9.5.1	Class of Service (COS) [5-1] .....	192
9.5.2	Denied Codes [5-2] .....	193
9.5.3	Exception Codes [5-3] .....	194
9.5.4	Emergency Number & Others [5-4] .....	195
<b>9.6</b>	<b>DISA [6]</b> .....	<b>198</b>
9.6.1	Automated Attendant [6-1] .....	198
9.6.2	Automated Attendant [6-1] AA dial .....	200
9.6.3	Settings [6-2] .....	201
9.6.4	Incoming Permission [6-3] .....	207
<b>9.7</b>	<b>Doorphone [7]</b> .....	<b>208</b>
9.7.1	Ringling & Door Opener [7-1] .....	208
9.7.2	Others [7-2] .....	210
<b>9.8</b>	<b>BV [8]</b> .....	<b>214</b>
9.8.1	Main [8-1] .....	214
9.8.2	Others [8-2] .....	216
<b>9.9</b>	<b>Caller ID [9]</b> .....	<b>218</b>
9.9.1	Main [9-1] .....	218
9.9.2	SLT Caller ID [9-2] .....	222
9.9.3	Call Log [9-3] .....	226
<b>Index</b> .....	<b>229</b>	



---

# **Section 1**

## **Overview**

*This section provides an overview of methods of programming the PBX, and information about password security.*

# 1.1 Introduction

## 1.1.1 Introduction

These programming instructions are designed to serve as an overall system programming reference for the Panasonic Advanced Hybrid System. The PBX has default settings that can be changed to meet your needs. These settings control the manner in which the PBX features described in this Programming Manual function, and changing these settings is referred to as "system programming". System programming can be performed by only one person at a time. A second person attempting to program the system will be denied access to system programming.

### Ways to program

There are 2 programming methods:

- **PT (Proprietary Telephone) Programming**  
PT programming is described in Section PT Programming. An authorized administrator or the manager can perform system programming by entering 3-digit programming numbers with a PT.
- **PC Programming**  
PC programming is described in Section 3.2 PC Programming.

### Password Security

To maintain system security, a password is required to perform system programming. When KX-TA Maintenance Console is started for the first time, the Quick Setup utility will ask you to set the system password. To avoid unauthorized access and possible fraudulent dialing, do not disclose the password.

#### ***Warning to the Administrator or Installer regarding the system password***

1. Please inform the customer of the importance of the password and the possible dangers if it becomes known to others.
2. To avoid unauthorized access and possible fraudulent dialing, maintain the secrecy of the password.
3. We strongly recommend that you change the default password value to something else for reasons of system security. It is best to use a password of 7 digits.
4. Please change the password periodically.
5. If a system password is forgotten, it can be found by loading a backup of the system data into a PC, and checking the password using the KX-TA Maintenance Console software. If you do not have a backup of the system data, you must reset the PBX to its factory defaults and reprogram it. Therefore, we strongly recommend maintaining a backup of the system data. For more information on how to back up the system data, refer to the on-line help that appears by selecting the Help menu during PC programming. However, as system passwords can be extracted from backup copies of the system data file, do not allow unauthorized access to these files.

#### **Notes**

This PBX has only one system password. It can be changed by either PT programming or PC programming. For this reason, the password can consist of numerals only.

---

## **Section 2**

# ***PT Programming***













*This section serves as reference operating instructions when using a display PT to program the PBX.*

# 2.1 PT Programming—Instructions

## Required Telephone

PBX settings can be customized through system programming by using a proprietary telephone (PT) with a display, such as the KX-T7731. An authorized administrator or the manager extension connected to extension jack 01 can access system programming.

### Buttons and Functions

Fixed Button (KX-T7700 series)	Function
	<b>PREV (PREVIOUS)</b>
	<b>NEXT</b>
	<b>➡</b>
	<b>⬅, -</b>
	<b>- , ➡</b>
	<b>SECRET</b>
	<b>STORE</b>
	<b>PAUSE</b>
	<b>PROGRAM</b>
	<b>END</b>
	<b>SELECT</b>
	<b>FLASH</b>

Fixed Button (KX-T7700 series)	Function
	<b>CLEAR</b>

## Entering System Programming Mode

Using a PT to perform system programming allows an authorized administrator to set a wide range of PBX features and parameters. To enter system programming mode, the system password is required. With the system password, all system programming is accessible.

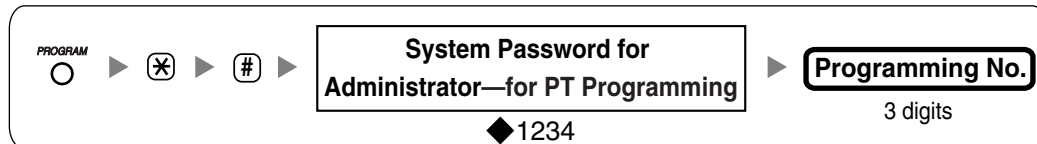

### Notes

- ◆ means default value throughout these programming instructions.

## Entering Manager Programming Mode

Using a PT to perform manager programming allows the manager extension (extension jack 01) to set certain PBX features and parameters. To enter manager programming mode, the extension password for the manager (manager password) is required.

With the manager password, the following 4 system programming settings are accessible:

- [001] System Speed Dialing Number
- [011] System Speed Dialing Name
- [512] DISA Security Code
- [530] DISA Security Code Digits

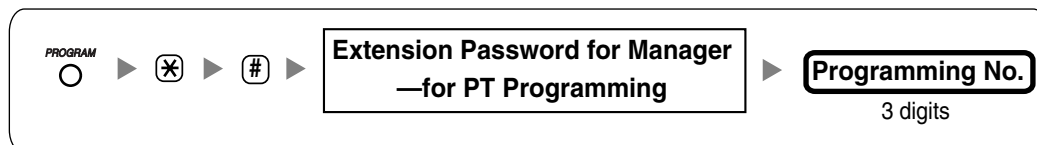

### Notes

- The system password may be entered instead of the manager password.
- With the manager password, the manager can also set a password to each extension. For more information on how to assign a password to each extension including the manager password, refer to the Operating Manual (→ 2.1.7 System Feature Assignment).

## Entering Characters

The PT's dialing buttons can be used to enter characters when storing a name or message. The following tables depict the available characters:

**Table 1 (Alphabet mode)/Table 2 (Numeral mode)**



Buttons \ Times	Times								Buttons \ Times	Times	
	1	2	3	4	5	6	7	8		Buttons	1
1	!	?	"							1	1
2	A	B	C	a	b	c				2	2
3	D	E	F	d	e	f				3	3
4	G	H	I	g	h	i				4	4
5	J	K	L	j	k	l				5	5
6	M	N	O	m	n	o				6	6
7	P	Q	R	S	p	q	r	s		7	7
8	T	U	V	t	u	v				8	8
9	W	X	Y	Z	w	x	y	z		9	9
0	(Space)	.	,	'	:	;				0	0
*	/	+	-	=	<	>				*	*
□	\$	%	&	@	(	)				□	□

### [Example of Entering Characters]

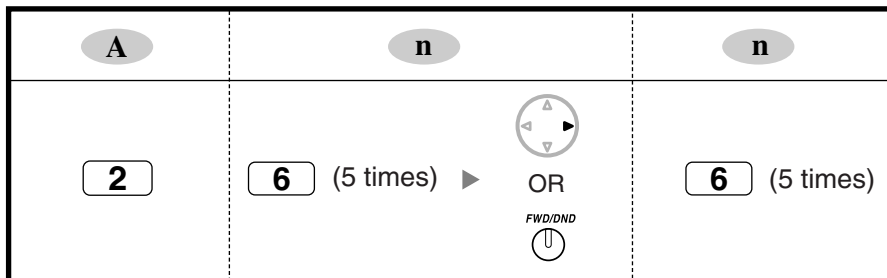
To enter "Ann":



### Notes

- To toggle between "Alphabet mode" and "Numeral mode", press SELECT.
- To move the cursor right, press .
- To delete all characters, press CLEAR. To delete a character, press .

## 2.2 PT Programming—Procedures

### Notes

- ◆ means default value throughout these programming instructions.
- × means to select "All" throughout these programming instructions.
- The following are displayed when you store a number, such as a telephone number, or feature number:  
P: PAUSE; -: CONF; F: FLASH/RECALL; [ ]: INTERCOM  
x: PAUSE (substitutes for any number [i.e., wild card])
- To return to the previous programming item, press ◀.
- To correct a wrong entry, press CLEAR and then enter the new input.
- To delete a stored parameter, press CLEAR, enter the new input, and then press STORE.
- Press ◀ or ▶ to scroll the display.
- Some programs cannot have a value left empty.

### [000] Date & Time

Selects the date and time of the PBX. The date and time will be shown on the displays of PTs and SMDR.

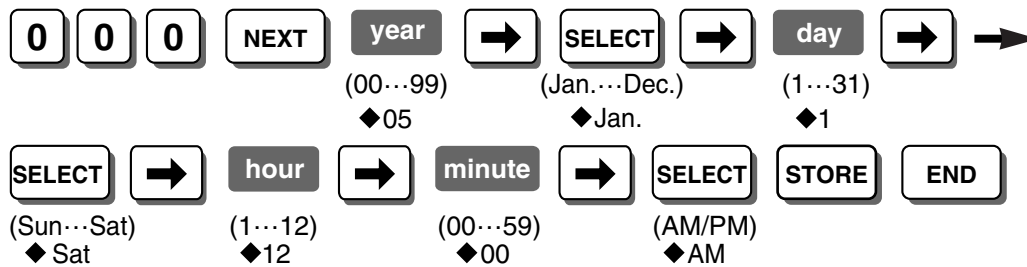

### Conditions

- The clock starts immediately after the STORE button is pressed.
- The PBX supports years from 2000 to 2099.

### Feature Manual References

1.1.43 Display Information

1.1.112 Station Message Detail Recording (SMDR)

## [001] System Speed Dialing Number

Used to store frequently dialed numbers. These numbers are available for all extension users when making or receiving calls.

A maximum of 100 System Speed Dialing numbers (e.g., telephone numbers, feature numbers) can be programmed.

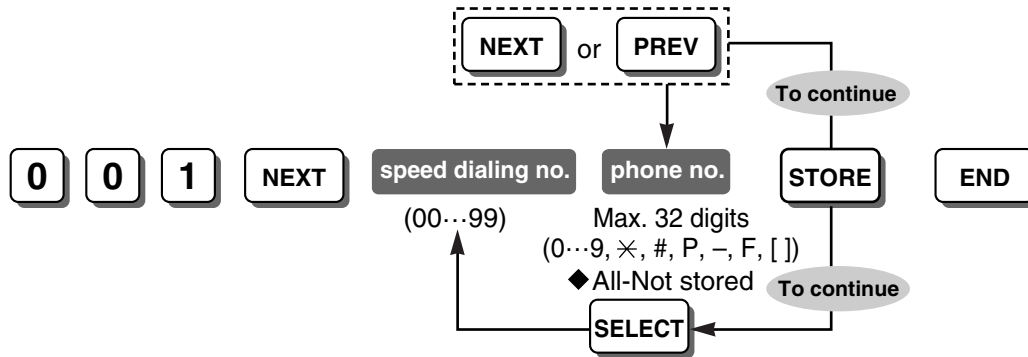

### Conditions

- An Outside (CO) Line Access number (9, 81 through 88) should be included before the phone number. When dialing, a pause will automatically be inserted after the Outside (CO) Line Access number.
- When storing an account code assigned in [310] Account Code, enter \*\* and the account code after an Outside (CO) Line Access number.

### Programming Manual References

[011] System Speed Dialing Name

[310] Account Code

### Feature Manual References

1.1.111 Secret Dialing

1.1.113 System Speed Dialing

## [002] System Password

Specifies the system password used to access system programming.

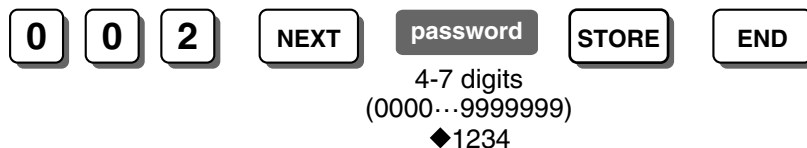

### **WARNING**

**To maintain system security, a password is required to perform system programming. To avoid unauthorized access and possible fraudulent dialing, do not disclose the password.**

#### **Warning to the Administrator regarding the system password**

1. Please inform the customer of the importance of the password and the possible dangers if it becomes known to others.

2. To avoid unauthorized access and possible fraudulent dialing, maintain the secrecy of the password.
3. We strongly recommend that you change the default password value to something else for reasons of system security. It is best to use a password of 7 digits.
4. Please change the password periodically.
5. If a system password is forgotten, it can be found by loading a backup of the system data into a PC, and checking the password using the KX-TA Maintenance Console software. If you do not have a backup of the system data, you must reset the PBX to its factory defaults and reprogram it. Therefore, we strongly recommend maintaining a backup of the system data. For more information on how to back up the system data, refer to the on-line help that appears by selecting the Help menu during PC programming. However, as system passwords can be extracted from backup copies of the system data file, do not allow unauthorized access to these files.

#### Notes

This PBX has only one system password. It can be changed by either PT programming or PC programming. For this reason, the password can consist of numerals only.

#### Programming Manual References

2.1 PT Programming—Instructions

3.2 PC Programming

#### Feature Manual References

1.1.99 PC Programming

1.1.103 PT Programming

## [003] DSS Console Jack Assignment

Selects the number of the extension jack that the DSS Console is connected to.

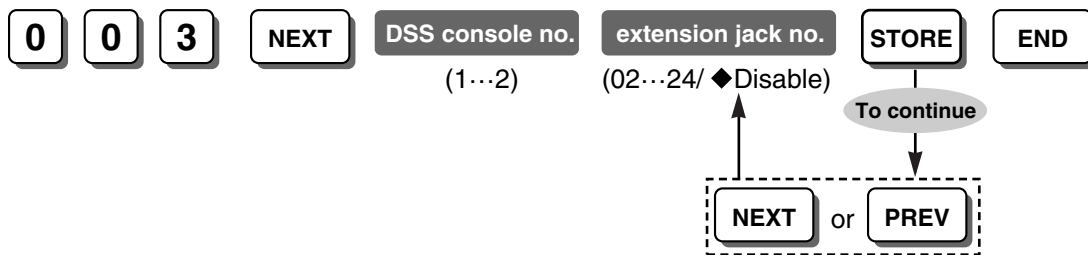

#### Conditions

- To delete (disable) an extension jack number, press CLEAR in the extension jack number step.
- The same jack number cannot be assigned to 2 DSS Consoles.
- Do not assign extension jack 01 (manager extension) as the DSS Console jack.
- The extension jack number preassigned as a paired telephone in [004] Console Paired Telephone should not be assigned in this program.

#### Programming Manual References

[004] Console Paired Telephone

#### Feature Manual References

1.1.54 Extension Jack Configuration

1.1.59 Fixed Buttons

### [004] Console Paired Telephone

Selects the extension jack number of the PT to be used in pair with the DSS Console.

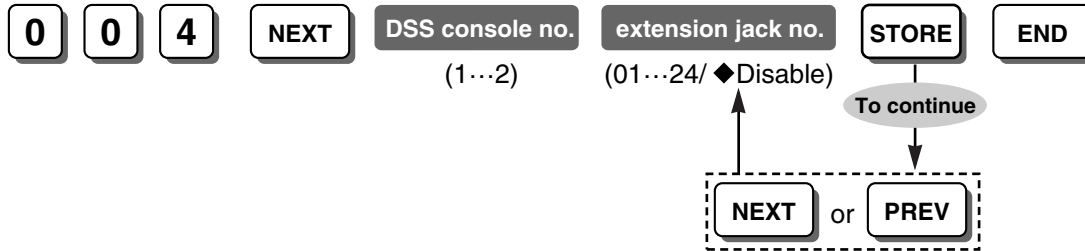

**Conditions**

- To delete (disable) an extension jack number, press CLEAR in the extension jack number step.
- The extension jack number preassigned as a DSS Console in [003] DSS Console Jack Assignment should not be assigned in this program.
- An SLT cannot be paired with the DSS Console.

**Programming Manual References**

[003] DSS Console Jack Assignment

**Feature Manual References**

1.1.54 Extension Jack Configuration

1.1.59 Fixed Buttons

### [005] One-touch Transfer Using a DSS Button

Selects how an outside (CO) line call is transferred to an extension using a DSS button.

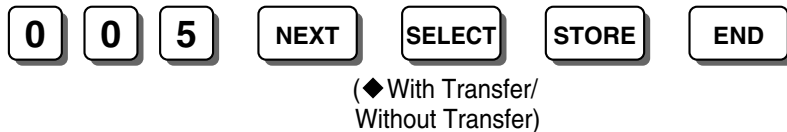

**Notes**

**With Transfer:** Press the DSS button to transfer an outside (CO) line call.

**Without Transfer:** Press the TRANSFER button, then the DSS button to transfer an outside (CO) line call.

**Feature Manual References**

1.1.25 Call Transfer—To Extension

1.1.59 Fixed Buttons

### [006] Time Service Switching Mode

Selects whether the time service mode is switched between day, lunch, and night manually or automatically.



**Programming Manual References**

[007] Time Service Start Time

**Feature Manual References**

1.1.114 Time Service

**[007] Time Service Start Time**

Enables the start times of each time service mode and end time of lunch mode for each day of the week.

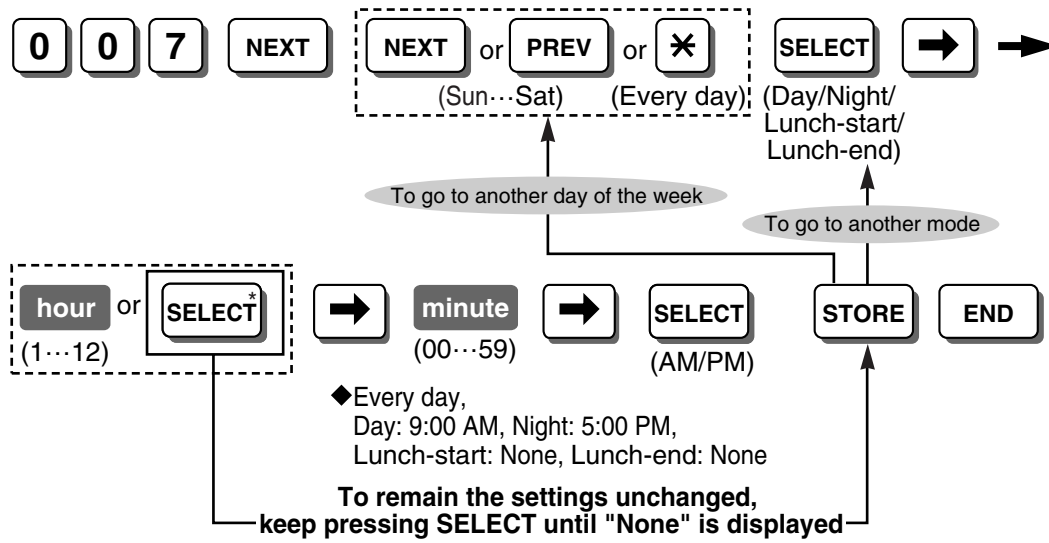

**Conditions**

- This program is available when switching mode is enabled in automatic mode in [006] Time Service Switching Mode.
- \* Pressing SELECT shows the previous entry. When the display shows "None", press SELECT to set the start time.

**Programming Manual References**

[006] Time Service Switching Mode

**Feature Manual References**

1.1.114 Time Service

**[008] Operator Assignment**

Selects the extension jack number to be designated as the operator.



**Conditions**

- To delete (disable) an extension jack number, press CLEAR in the extension jack number step.

**Feature Manual References**

1.1.87 Operator/Manager Features

**[009] Extension Number**

Specifies an extension number for each extension.

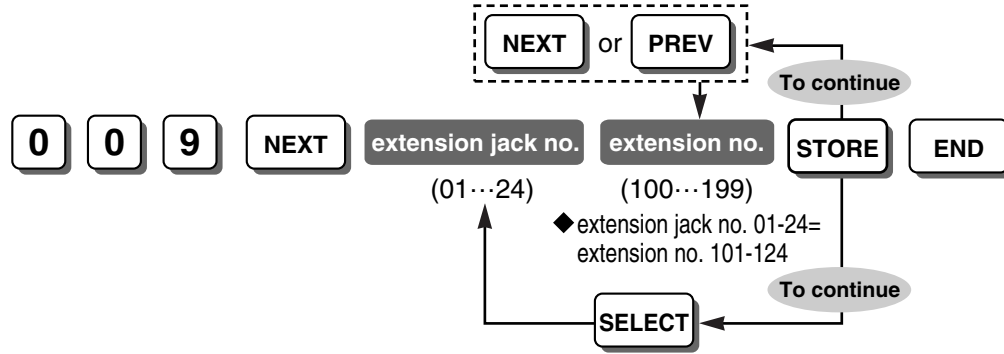

**Conditions**

- The same extension number cannot be entered for 2 different extension jacks.

**Programming Manual References**

[604] Extension Name

**Feature Manual References**

- 1.1.43 Display Information
- 1.1.57 Feature Numbering
- 1.1.69 Intercom Call

**[010] LCD Time Display**

Selects the time format shown on the displays of PTs while on-hook.

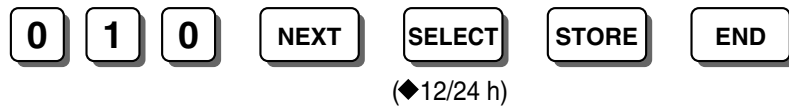

**Conditions**

- The following settings and features use 12-hour format even if 24-hour format is assigned in this program:
  - [000] Date & Time
  - [007] Time Service Start Time
  - 1.1.112 Station Message Detail Recording (SMDR)
  - 1.1.115 Timed Reminder

**Programming Manual References**

- [000] Date & Time
- [007] Time Service Start Time

**Feature Manual References**

- 1.1.43 Display Information

- 1.1.112 Station Message Detail Recording (SMDR)
- 1.1.115 Timed Reminder

## [011] System Speed Dialing Name

Specifies a name for the System Speed Dialing number. The name will be displayed when making a call by using the System Speed Dialing feature. It will also be displayed when a matching number is received with the Caller ID feature.

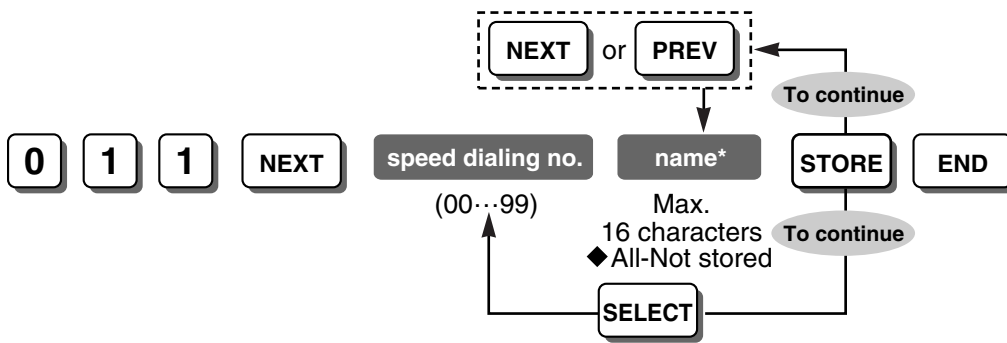

### Conditions

- \* A name can be stored using a PT's dialing buttons. The displayed character varies depending on the number of times that the dialing button is pressed. It is possible to toggle between "Alphabet mode" and "Numeral mode" by pressing SELECT.

### Programming Manual References

- 2.1 PT Programming—Instructions—Entering Characters
- [001] System Speed Dialing Number

### Feature Manual References

- 1.1.113 System Speed Dialing

## [100] Hunting Group Set

Enables the redirection of calls to an idle member of the same extension group when the called extension is busy.

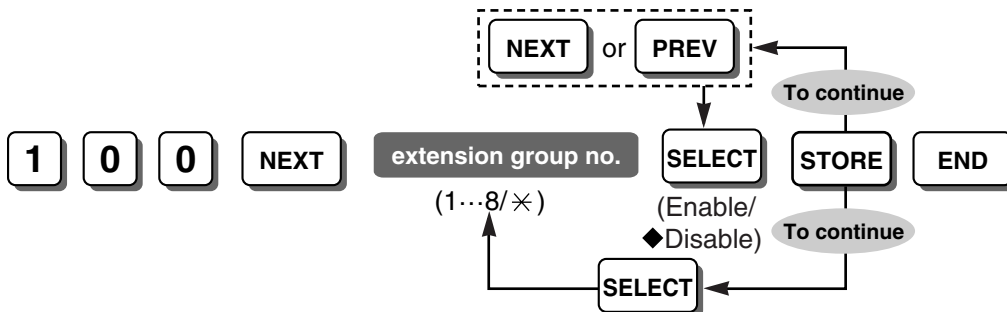

### Programming Manual References

- [600] Extension Group

### Feature Manual References

- 1.1.67 Idle Extension Hunting

## [101] Hunting Type

Selects the hunting type for each group.

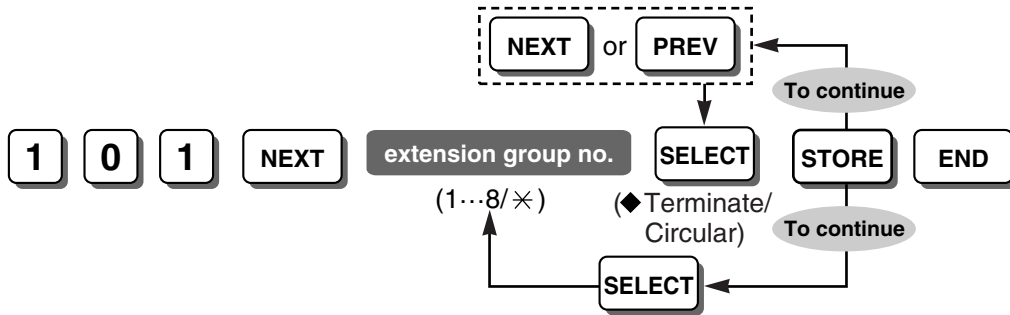

### Notes

- Circular:** Circulates until the call is answered.
- Terminate:** Terminates at the last extension.

### Conditions

- This program is available when the extension group is enabled in [100] Hunting Group Set.

### Programming Manual References

- [100] Hunting Group Set
- [600] Extension Group

### Feature Manual References

- 1.1.67 Idle Extension Hunting

## [102] DTMF Integration Port

Enables the extension jack number(s) (07, 08, 15, 16) to be connected to a Panasonic VPS and specified as the voice mail ports.

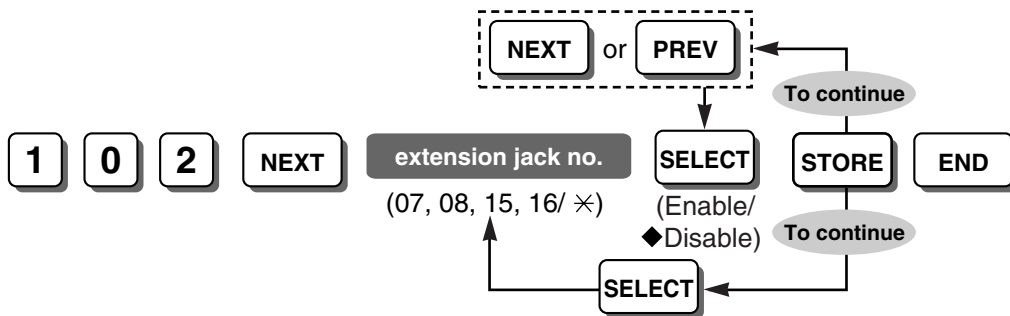

### Feature Manual References

- 1.1.121 Voice Mail Inband (DTMF) Integration

## [103] DTMF Integration

Enables Inband (DTMF) Integration between the VPS and the PBX when a KX-TVS series VPS/KX-TVA series VPS is connected to the PBX. The VPS and PBX communicate with each other by sending DTMF signals.

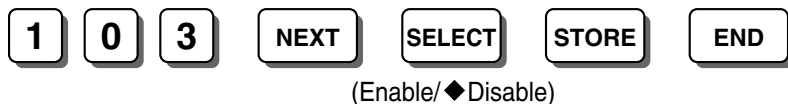

### Conditions

- In order to select "Enable" in this program, [130] VM 1 APT Port and [131] VM 2 APT Port should first be set to "Disable".
- Please refer to 1.1.121 Voice Mail Inband (DTMF) Integration in the Feature Manual for details about such as DTMF status signals.

### Programming Manual References

[102] DTMF Integration Port

### Feature Manual References

1.1.121 Voice Mail Inband (DTMF) Integration

## [104] SLT Hold Mode

Selects how calls are held and transferred with an SLT when the Recall/hookswitch is pressed for less than 1000 ms.

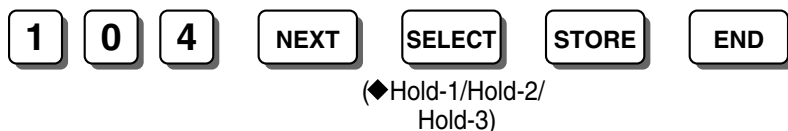

### Feature Manual References

1.1.15 Call Hold

## [105] Conference Tone

Enables the PBX to send a confirmation tone before starting or ending a conference call established by the Conference feature or Executive Busy Override feature.

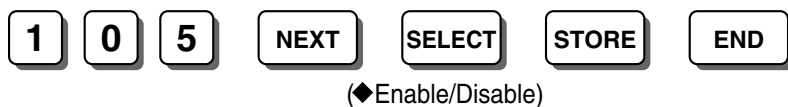

### Feature Manual References

1.1.33 Conference

1.1.50 Executive Busy Override—Extension

1.1.51 Executive Busy Override—Outside (CO) Line

## [106] External Pager Access Tone

Enables the PBX to send a confirmation tone to the external pager before a paging announcement.

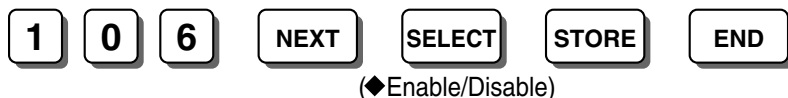

**Feature Manual References**

- 1.1.94 Paging—All Extensions & External
- 1.1.95 Paging—External

**[107] DTMF Receiver Check**

Enables each DTMF receiver to check whether it is operating normally or not.

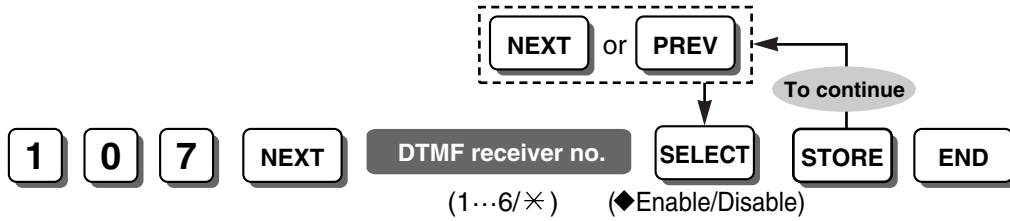

**Notes**

**DTMF receiver number:**

- 1–2: checking extension jacks 01–08
- 3–4: checking extension jacks 09–16
- 5–6: checking extension jacks 17–24

**Installation Manual References**

- 4.1.3 Operation

**[108] Flash/Recall Mode for a Locked Extension**

Enables a locked extension to send a flash/recall signal during a conversation with an outside party.

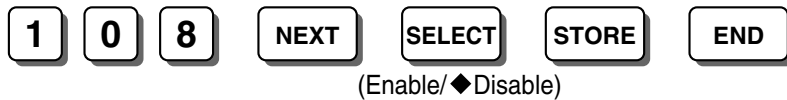

**Feature Manual References**

- 1.1.55 Extension Lock
- 1.1.107 Remote Extension Lock

**[109] CO Indicator**

Enables the corresponding PTs to answer incoming outside (CO) line calls. The CO button indicator will flash when an outside (CO) line call is received. If this program is enabled, a PT user can answer the call by pressing the flashing CO button. If this program is disabled, the user cannot answer the call even if he or she presses the CO button.

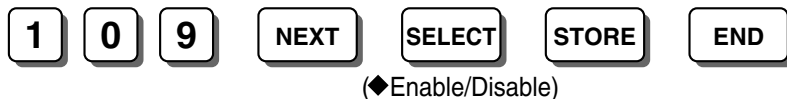

**Conditions**

- This program is available for the extension(s) assigned not to ring in [408-410] Flexible Ringing—Day/Night/Lunch, to answer incoming outside (CO) line calls.

**Programming Manual References**

- [408-410] Flexible Ringing—Day/Night/Lunch

## [110] Flash/Recall Key Mode

Selects the function of the FLASH/RECALL button on a PT during a conversation with an outside party.



(MODE1: EFA mode/  
◆MODE2: Flash/Recall mode)

### Feature Manual References

- 1.1.56 External Feature Access (EFA)
- 1.1.60 Flash/Recall

## [111] Music on Hold

Selects the audio source for Music on Hold and BGM.



(◆External/Tone)

### Feature Manual References

- 1.1.7 Background Music (BGM)
- 1.1.85 Music on Hold

## [112] DSS Lamp Mode

Enables the Busy Lamp Field (BLF) on the DSS button to indicate the status, FWD or DND, of corresponding extensions.



(◆Enable/Disable)

### Notes

- Enable:** FWD—Flashing slowly, DND—Flashing at moderate speed
- Disable:** FWD—Off, DND—Off

### Feature Manual References

- 1.1.70 LED Indication

## [115] Extension Ring Tone Pattern

Selects the extension ring tone pattern for incoming intercom calls.



(Single/◆Double/  
Triple)

### Feature Manual References

- 1.1.69 Intercom Call
- 1.1.108 Ring Tone Pattern Selection
- 2.2.1 Tones/Ring Tones

## [117] Call Pickup Tone

Enables the PBX to send a confirmation tone when the Call Pickup feature is activated.

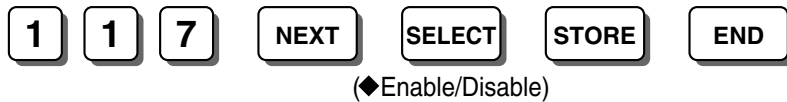

### Feature Manual References

1.1.20 Call Pickup, Directed

1.1.21 Call Pickup, Group

## [118] Pulse Restriction

Enables the PBX to send pulse dialing to the telephone company during a conversation with an outside party when "Pulse" or "Call Block" mode is enabled in [401] Dial Mode.

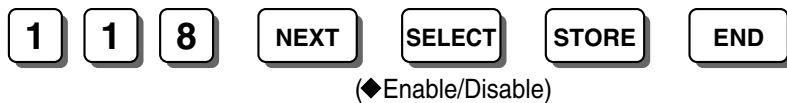

### Programming Manual References

[401] Dial Mode

## [119] Redialing after Pulse to Tone Conversion

Enables the PBX to send DTMF dialing to the telephone company when an extension user redials after changing from pulse mode to DTMF mode by pressing "\*#".

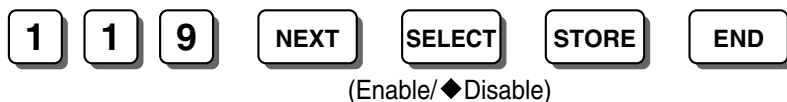

### Feature Manual References

1.1.104 Pulse to Tone Conversion

## [125] TRS Check for \* and #

Enables TRS to check for the user-dialed digits "\*" and "#". This is useful in preventing some unauthorized calls.

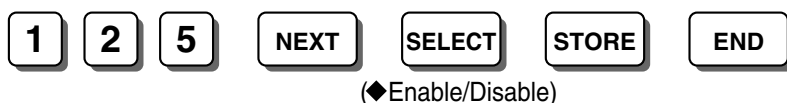

### Feature Manual References

1.1.117 Toll Restriction (TRS)

## [128] Ringback Tone Pattern

Selects the ringback tone pattern for outgoing intercom calls and for incoming outside (CO) line calls (including a DISA call).

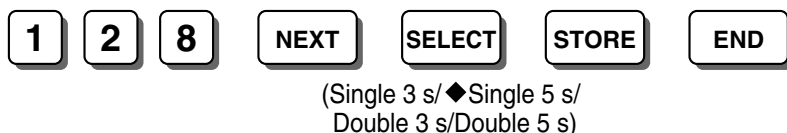

**Feature Manual References**

- 1.1.41 Direct Inward System Access (DISA)
- 1.1.69 Intercom Call
- 2.2.1 Tones/Ring Tones

**[130] VM 1 APT Port**

Enables the extension jack number(s) (07, or 07 and 08) to be connected to a Panasonic VPS and specified as the voice mail APT ports.



(Port7/Port7 & 8/  
◆Disable)

**Conditions**

- To change the current setting (other than "Disable"), select "Disable", then select the desired setting.
- This program is not available when "Enable" is selected in [103] DTMF Integration.

**Programming Manual References**

[103] DTMF Integration

**Feature Manual References**

1.1.120 Voice Mail APT Integration

**[131] VM 2 APT Port**

Enables the extension jack number(s) (15, or 15 and 16) to be connected to a Panasonic VPS and specified as the voice mail APT ports.



(Port15/  
Port15 & 16/  
◆Disable)

**Conditions**

- To change the current setting (other than "Disable"), select "Disable", then select the desired setting.
- This program is not available when "Enable" is selected in [103] DTMF Integration.

**Programming Manual References**

[103] DTMF Integration

**Feature Manual References**

1.1.120 Voice Mail APT Integration

## [142] SLT Ring/Silence Ratio

Selects the ratio between the bell signals of an SLT (a set of bell-on and bell-off).



### Programming Manual References

[143] SLT Ring Bell-on Time

### Feature Manual References

1.1.108 Ring Tone Pattern Selection

## [143] SLT Ring Bell-on Time

This program selects the length of the bell-on signal of an SLT. This determines the ring tone pattern for incoming calls to SLTs, combined with the setting in [142] SLT Ring/Silence Ratio.

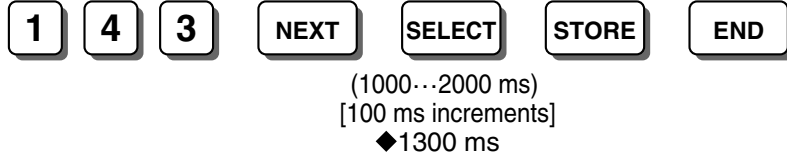

### Conditions

- This program also determines the maximum number of digits of an SLT Caller ID number, when "DTMF1" or "DTMF2" is selected in [150] SLT Caller ID Signaling Type.

### Programming Manual References

[142] SLT Ring/Silence Ratio

[150] SLT Caller ID Signaling Type

### Feature Manual References

1.1.30 Caller ID

1.1.108 Ring Tone Pattern Selection

## [150] SLT Caller ID Signaling Type

Selects the signaling type of SLT Caller ID.

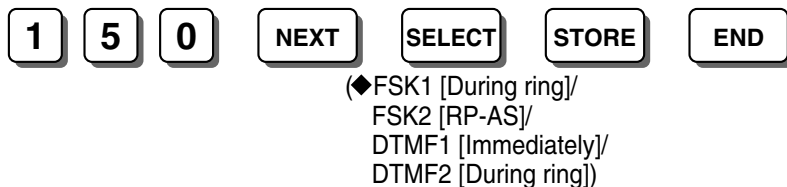

### Feature Manual References

1.1.30 Caller ID

## [151] SLT Caller ID Line Access Number

Enables the PBX to automatically add an Outside (CO) Line Access number to the received telephone number when sending the Caller ID number of an incoming outside (CO) line call to an SLT.

**1** **5** **1** **NEXT** **SELECT** **STORE** **END**

(◆Enable/Disable)

### Feature Manual References

1.1.30 Caller ID

## [152] Automatic Time Adjustment

Enables the PBX to adjust its clock every day according to the time information included with the first Caller ID call after 3:05 A.M.

**1** **5** **2** **NEXT** **SELECT** **STORE** **END**

(◆Enable/Disable)

### Feature Manual References

1.1.6 Automatic Time Adjustment

## [200] Hold Recall Time

Selects the length of time a call on hold waits to be retrieved. If the call on hold is not retrieved within the time period programmed here, a ring tone will be heard at the extension that put the call on hold. If the extension is engaged in a call, an alarm tone will be heard.

**2** **0** **0** **NEXT** **SELECT** **STORE** **END**

(◆30 s/  
1/1.5/2/3/4/5/6 min/  
Disable)

### Feature Manual References

1.1.15 Call Hold

1.1.17 Call Hold Retrieve

1.1.19 Call Park

## [201] Transfer Recall Time

Selects the length of time a transferred call waits to be answered. If the transfer destination does not answer the call within the time period programmed here, the call will return to the extension that transferred the call.

**2** **0** **1** **NEXT** **SELECT** **STORE** **END**

(15/◆30 s/  
1/2 min)

### Feature Manual References

1.1.25 Call Transfer—To Extension

**[202] Call Forwarding Start Time**

Selects the length of time before a call is forwarded when the call is not answered.



(5/10/◆15/  
20 s delay)

**Feature Manual References**

1.1.12 Call Forwarding (FWD)—Busy/No Answer

**[203] Hot Line Waiting Time**

Selects the length of time until automatic dialing starts after an SLT user goes off-hook.



(0...4 s)  
◆3 s

**Feature Manual References**

1.1.66 Hot Line

**[204] Call Duration Counter Start**

Selects when the call timer starts, either immediately after an outside (CO) line is seized, or after the end of dialing. This corresponds to the length of the conversation displayed on the LCD and logged by SMDR.



(5/◆10/15/20/25/30/35/  
40/45/50 s after dialing/  
Instantly)

**Feature Manual References**

1.1.43 Display Information

1.1.112 Station Message Detail Recording (SMDR)

**[205] CO-to-CO Line Call Duration**

Selects the maximum length of time allowed for a conversation between 2 outside parties using the FWD to Outside (CO) Line, Call Transfer to Outside (CO) Line, Unattended Conference, or DISA feature.



(1...32 min)  
◆10 min

**Feature Manual References**

1.1.91 Outside-to-Outside (CO-to-CO) Line Call Duration

## [206] Dialing Start Time

Selects the minimum length of time that the PBX waits after seizing an outside (CO) line before dialing.



(◆0/250/500/750/  
1000/1250/1500 ms)

### Feature Manual References

1.1.71 Line Access, Outside (CO) Line—SUMMARY

## [208] Inter-digit Time

Selects the length of time allowed between digits for an outgoing outside (CO) line call.



(5/◆10/15/20 s)

### Programming Manual References

[211] No Dial Disconnection

### Feature Manual References

1.1.117 Toll Restriction (TRS)

## [211] No Dial Disconnection

Selects whether or not to disconnect an outside (CO) line when an extension user does not dial anything within 10 seconds after seizing the outside (CO) line.



(Enable/◆Disable)

### Programming Manual References

[208] Inter-digit Time

### Feature Manual References

1.1.117 Toll Restriction (TRS)

## [214] BV Recording Time

Selects the maximum recording time for each voice message.



(1...20 min)  
◆5 min

### Feature Manual References

1.1.8 Built-in Voice Message (BV)

## [215] Common/Personal BV OGM Recording Time

Selects the maximum recording time for each personal/common BV OGM.



### Feature Manual References

1.1.8 Built-in Voice Message (BV)

## [300] Carrier Exception Code

Specifies the Carrier Exception codes. The PBX can recognize a user-dialed carrier code in order to apply TRS. The PBX disregards the assigned code and TRS is applied to the numbers after the code.

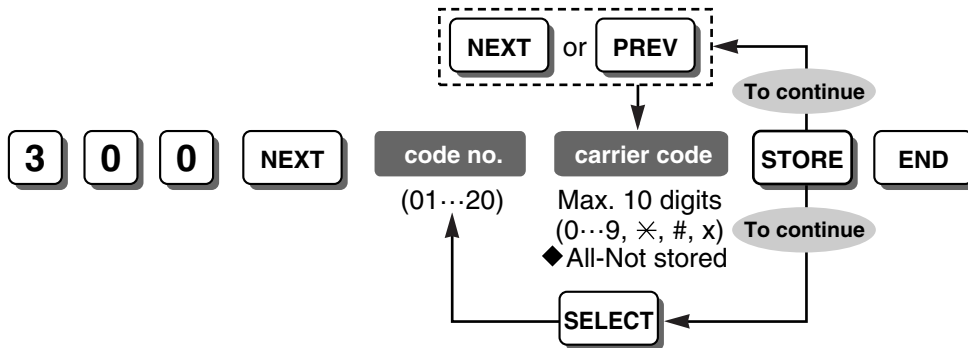

### Feature Manual References

1.1.117 Toll Restriction (TRS)

## [301] TRS—System Speed Dialing Class

Selects the COS of System Speed Dialing numbers. Calls made using System Speed Dialing are restricted depending on the COS programmed here and the COS assigned to each extension.

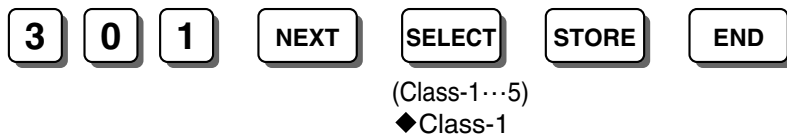

### Feature Manual References

1.1.113 System Speed Dialing

1.1.117 Toll Restriction (TRS)

## [302-305] TRS—COS 2-5 Denied Code

Specifies the toll-restricted numbers for classes 2–5.

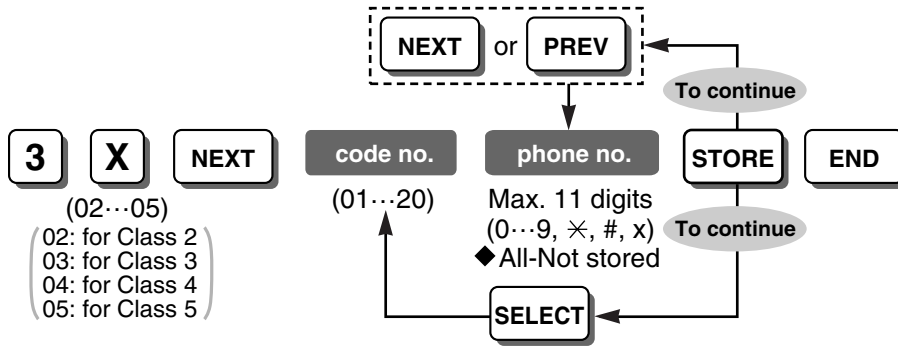

### Programming Manual References

[306] TRS—Exception Code

[601-603] TRS-COS—Day/Night/Lunch

### Feature Manual References

1.1.117 Toll Restriction (TRS)

## [306] TRS—Exception Code

Specifies the numbers to be exempted from TRS in each class range.

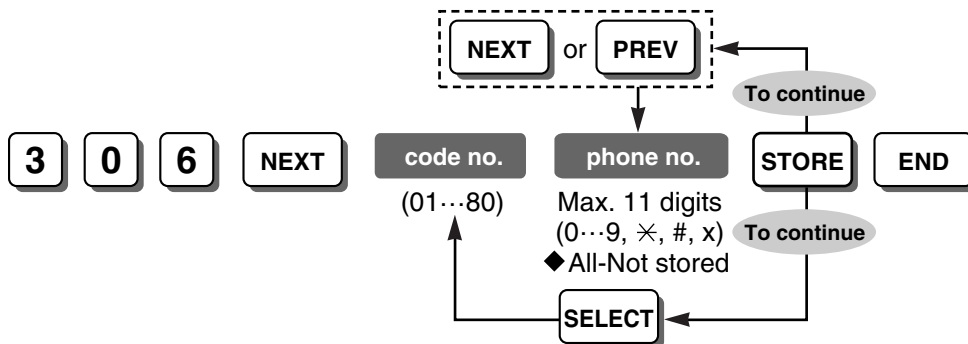

### Programming Manual References

[302-305] TRS—COS 2-5 Denied Code

### Feature Manual References

1.1.117 Toll Restriction (TRS)

### [309] Emergency Number

Specifies the numbers used for making emergency calls. It is not necessary to prefix the emergency number with an Outside (CO) Line Access number.

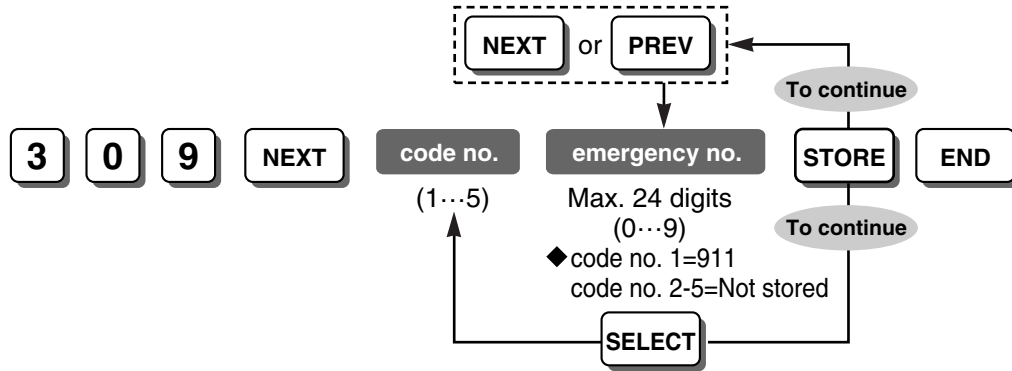

#### Feature Manual References

- 1.1.49 Emergency Call
- 1.1.117 Toll Restriction (TRS)

### [310] Account Code

Specifies the account codes that must be entered when "Verify-All " (an account code is required to make an outside (CO) line call) or "Verify-Toll " (an account code is required to override TRS temporarily) is selected in [605] Account Code Mode.

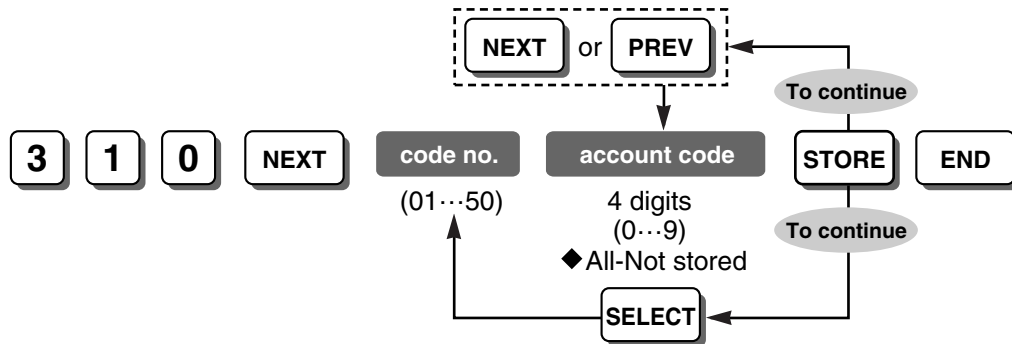

#### Programming Manual References

- [605] Account Code Mode

#### Feature Manual References

- 1.1.2 Account Code Entry
- 1.1.118 Toll Restriction (TRS) Override by Account Code

### [311] Automatic Pause Insertion Code

Specifies the Automatic Pause Insertion codes that are checked with the outgoing outside (CO) line call number. A maximum of 40 Automatic Pause Insertion codes can be programmed. When a dialed telephone number matches one of the Automatic Pause Insertion codes specified here, a pause will be automatically inserted after the code. This is particularly convenient if a second dial tone is sent from your telephone company.

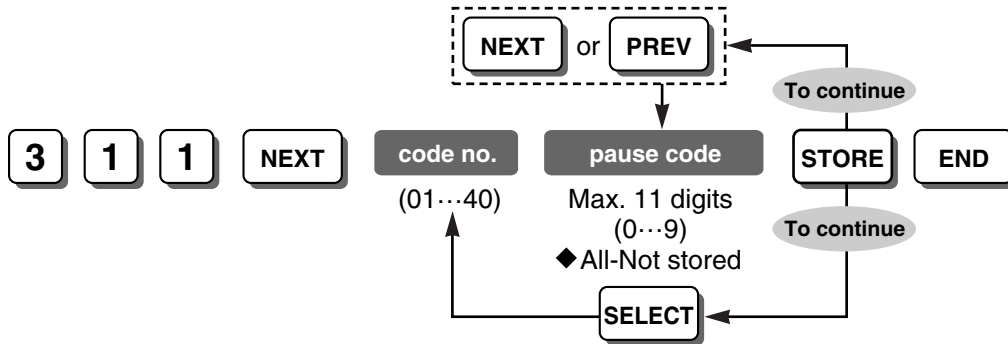

#### Programming Manual References

[417] Pause Time

#### Feature Manual References

1.1.98 Pause Insertion

### [312] TRS—Extension Lock Class

Selects the COS of locked extensions.

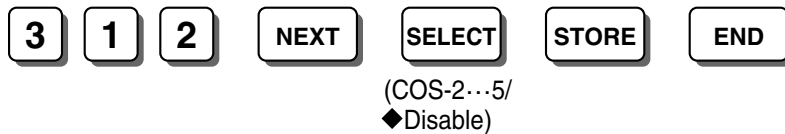

#### Feature Manual References

1.1.55 Extension Lock

1.1.107 Remote Extension Lock

1.1.117 Toll Restriction (TRS)

### [400] CO Line Connection

Specifies which outside (CO) lines are connected to the PBX.

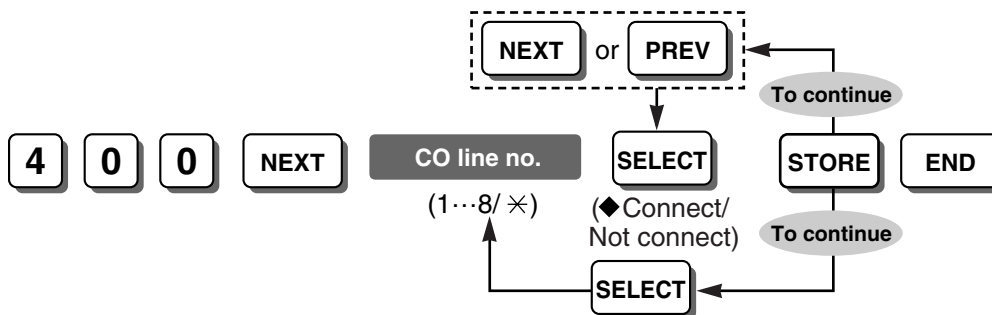

**Conditions**

- The numbers of outside (CO) line ports that do not have lines connected should be set to "Not connect". The PBX seizes the highest available outside (CO) line number when selecting an idle outside (CO) line automatically. If an unconnected outside (CO) line number is set to "Connect" and is numbered higher than any connected outside (CO) line number, the PBX will try to seize the unconnected outside (CO) line.

**Feature Manual References**

- 1.1.71 Line Access, Outside (CO) Line—SUMMARY
- 1.1.76 Line Preference—Outgoing

**[401] Dial Mode**

Selects the type of signal used to dial out using an outside (CO) line.

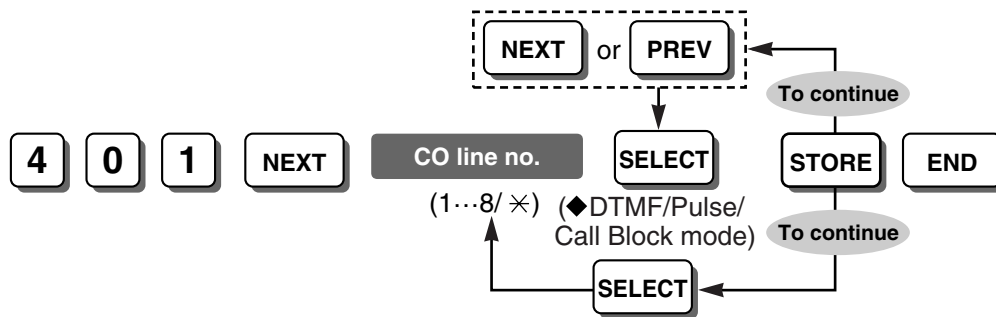

**Programming Manual References**

- [402] Pulse Speed

**Feature Manual References**

- 1.1.39 Dial Type Selection

**[402] Pulse Speed**

Selects the speed at which pulse signals are sent to the outside (CO) lines for which Dial Mode in [401] Dial Mode is set to "Pulse" or "Call Blocking".

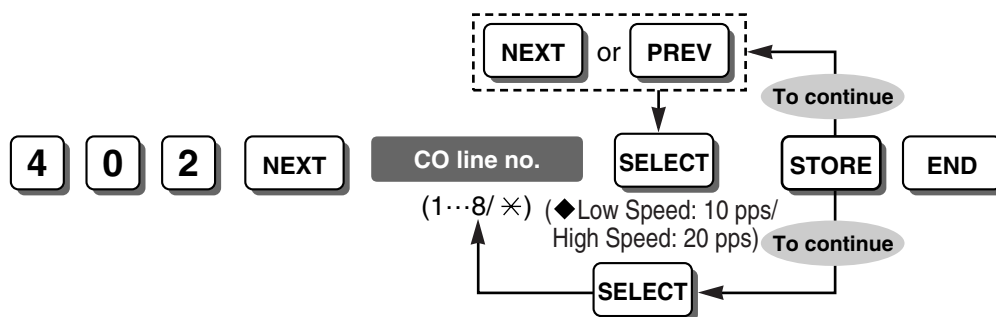

**Programming Manual References**

- [401] Dial Mode

**Feature Manual References**

- 1.1.39 Dial Type Selection

## [403] Host PBX Access Code

Specifies the Host PBX Access code used to access an outside (CO) line from the host PBX.

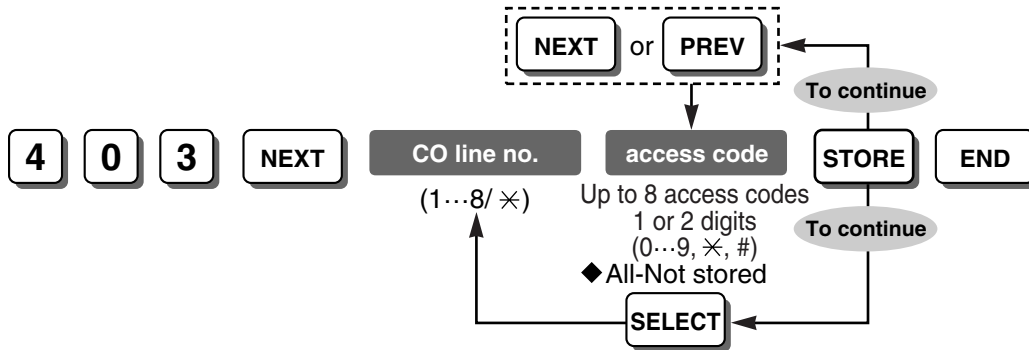

### Conditions

- Insert "," (CONF/MESSAGE button) between each access code using the comma button on the overlay. For example, to store access codes 81 and 82 on outside (CO) line 1, program as follows:  
403 NEXT 1 81,82 STORE END

### Programming Manual References

[417] Pause Time

### Feature Manual References

1.1.65 Host PBX Access Code (Access Code to the Telephone Company from a Host PBX)

## [404] CO Line Group Number

Selects the outside (CO) line group that each outside (CO) line is assigned to.

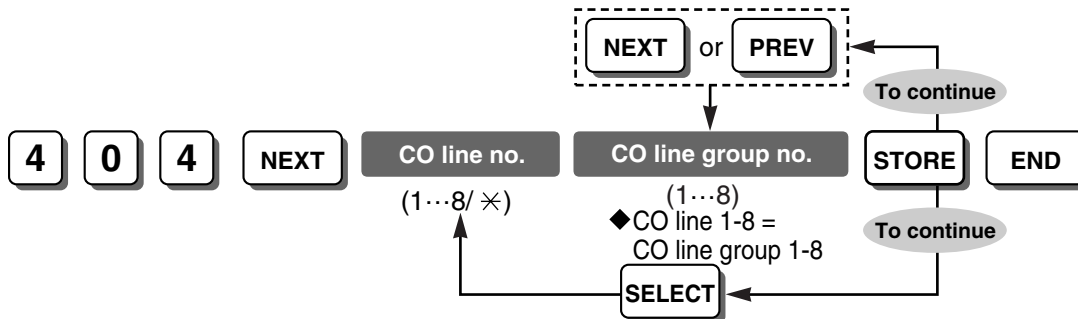

### Feature Manual References

1.1.73 Line Access, Outside (CO) Line Group

1.1.89 Outside (CO) Line Group

## [405-407] Flexible Outward Dialing—Day/Night/Lunch

Specifies which extensions can make outside (CO) line calls in each time service mode.

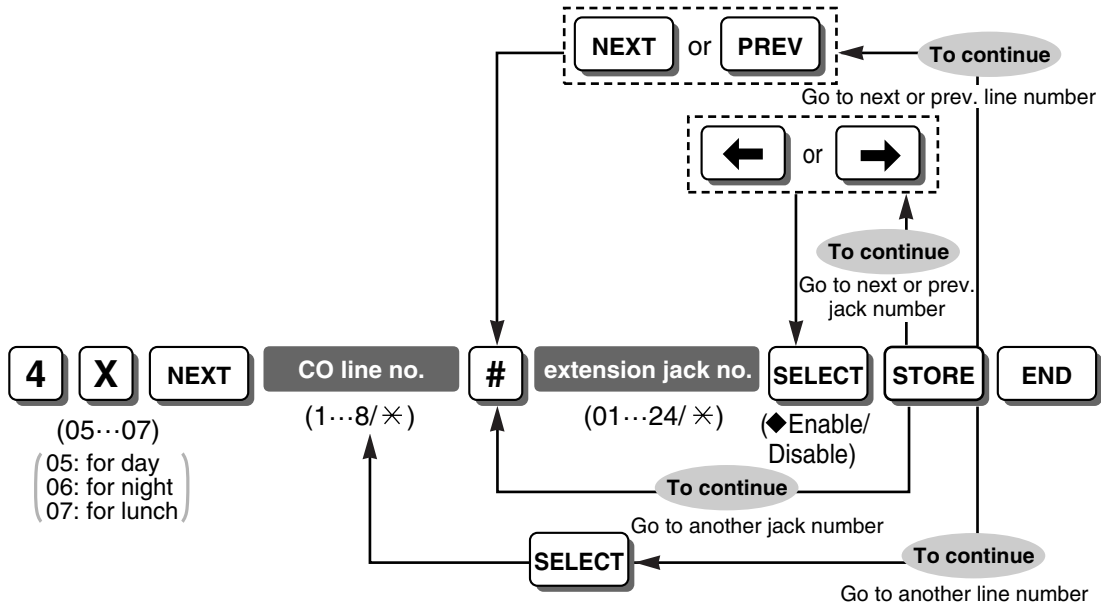

### Conditions

- It is impossible to disable all extensions for all outside (CO) lines in each time service mode. In each mode, at least one extension must be allowed to make an outside (CO) line call.

### Feature Manual References

1.1.71 Line Access, Outside (CO) Line—SUMMARY

1.1.76 Line Preference—Outgoing

## [408-410] Flexible Ringing—Day/Night/Lunch

Selects whether the extension will ring or not for incoming outside (CO) line calls in each time service mode.

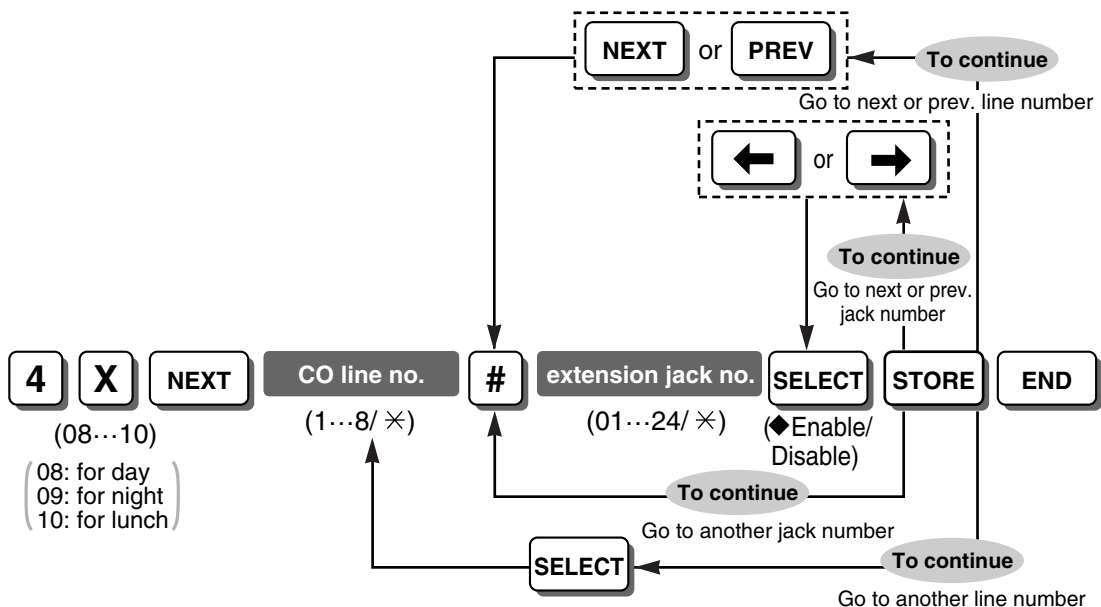

**Feature Manual References**

- 1.1.75 Line Preference—Incoming
- 1.1.90 Outside (CO) Line Ringing Selection
- 1.1.109 Ringing, Delayed

**[411-413] Delayed Ringing—Day/Night/Lunch**

Specifies the delay after a call is received before the extension starts to ring if the extension is set to ring in [408-410] Flexible Ringing—Day/Night/Lunch.

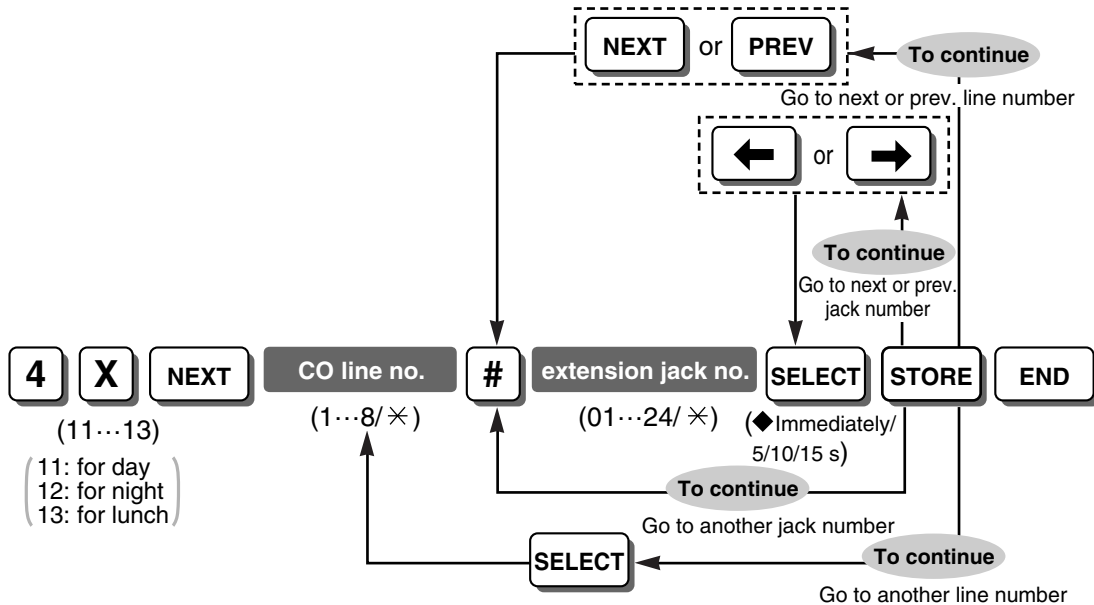

**Programming Manual References**

[408-410] Flexible Ringing—Day/Night/Lunch

**Feature Manual References**

- 1.1.42 Direct Inward System Access (DISA) Ring
- 1.1.75 Line Preference—Incoming
- 1.1.109 Ringing, Delayed

**[414-416] CO Line Mode—Day/Night/Lunch**

Selects the distribution method for incoming outside (CO) line calls in each time service mode. Depending on the distribution method selected, it may also be necessary to select a specific destination.

<To select Normal and/or MODEM>

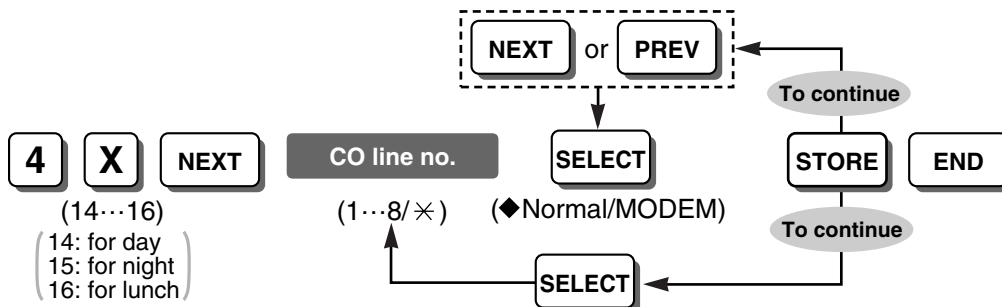

<To select BV>

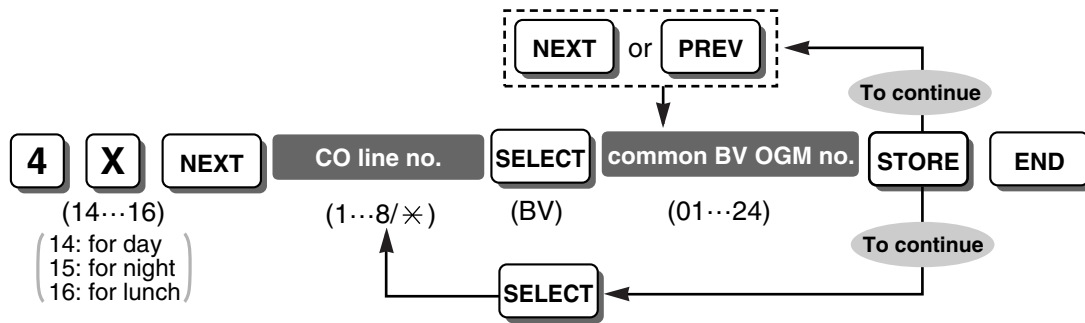

<To select DISA>

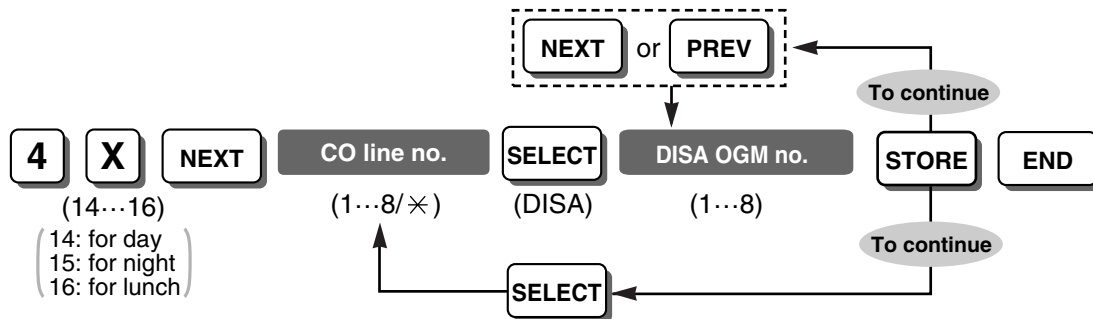

<To select DIL>

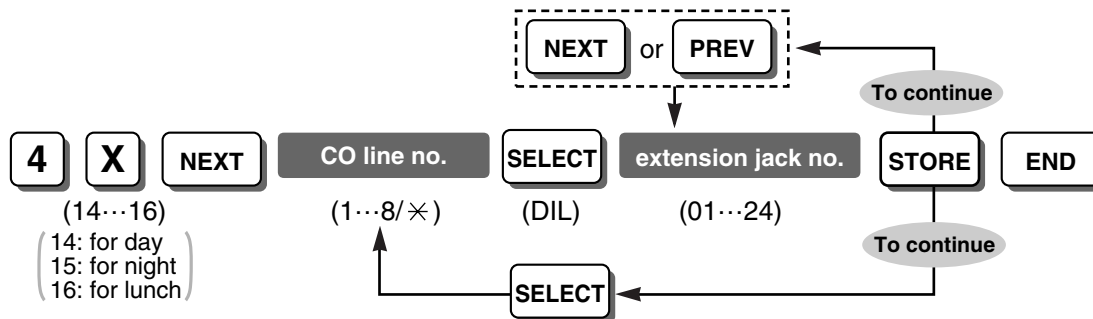

**Conditions**

- After you select "BV", do not change [008] Operator Assignment.

**Programming Manual References**

[008] Operator Assignment  
 [408-410] Flexible Ringing—Day/Night/Lunch

**Feature Manual References**

1.1.8 Built-in Voice Message (BV)  
 1.1.40 Direct In Line (DIL)  
 1.1.41 Direct Inward System Access (DISA)  
 1.1.99 PC Programming



## [419] Automatic Designated Line Access

Specifies which outside (CO) line is seized automatically when an extension user dials the Automatic Line Access number (9).

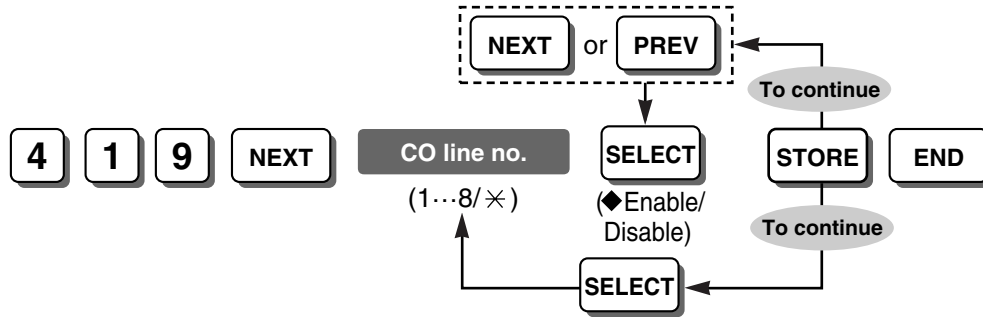

### Feature Manual References

1.1.72 Line Access, Automatic

1.1.76 Line Preference—Outgoing

## [420] CPC Signal Detection—Incoming

Selects the length of time required by the PBX to detect a CPC signal from an incoming outside (CO) line call before disconnecting the line.

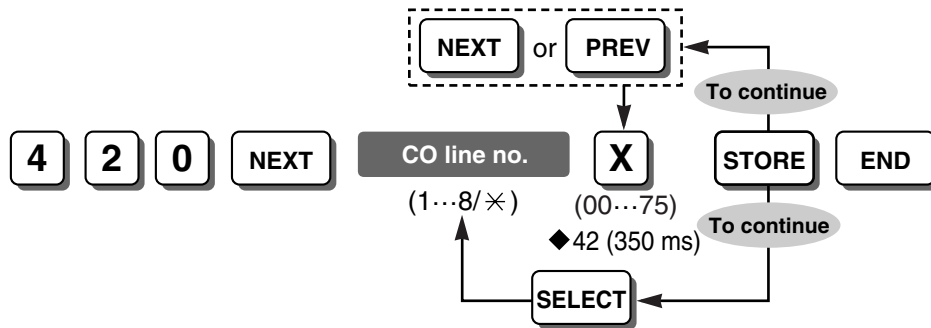

### Notes

**CPC signal detect time selection number:**

00: Disable; 01–75: 22–614 ms (detect time: 8 ms increments)

### Programming Manual References

[421] CPC Signal Detection—Outgoing

### Feature Manual References

1.1.31 Calling Party Control (CPC) Signal Detection

## [421] CPC Signal Detection—Outgoing

Enables the PBX to detect a CPC signal from outgoing outside (CO) line calls. If disabled, CPC signal detection is only activated during an incoming outside (CO) line call.

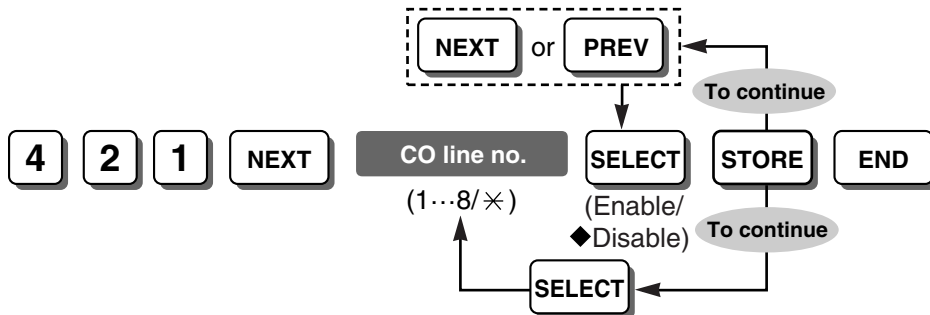

### Programming Manual References

[420] CPC Signal Detection—Incoming

### Feature Manual References

1.1.31 Calling Party Control (CPC) Signal Detection

## [422] Disconnect Time

Selects the length of the disconnect signal sent from the PBX to the telephone company or host PBX.

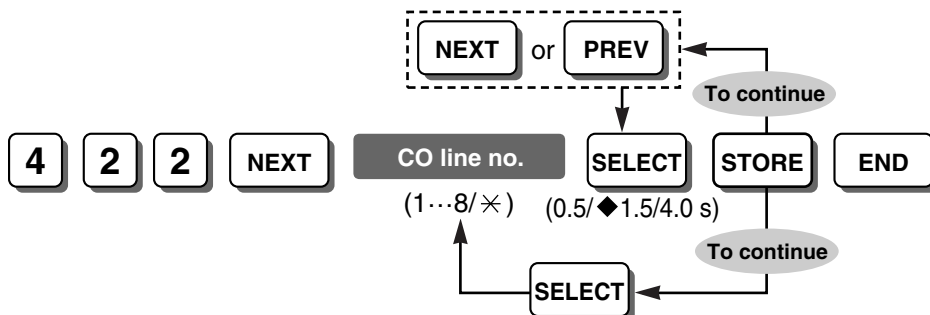

### Conditions

- The time you select must be longer than the requirements of your telephone company or host PBX.

### Feature Manual References

1.1.60 Flash/Recall

## [423] CO Line Ring Tone Pattern

Selects the ring tone pattern for incoming outside (CO) line calls.

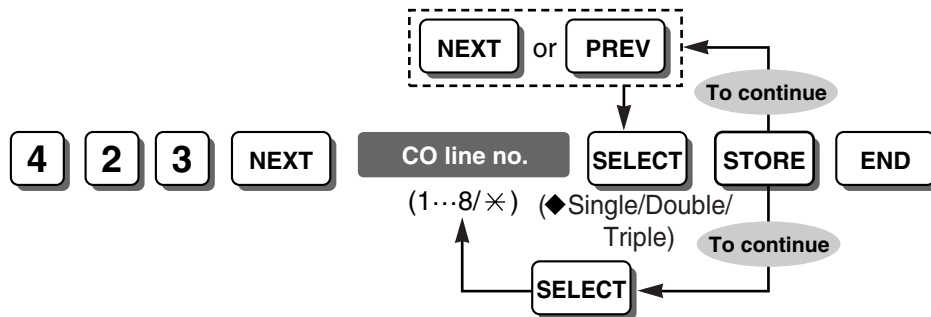

### Conditions

- It is recommended that you set a different ring tone pattern from the ring tone patterns specified in [115] Extension Ring Tone Pattern and [706] Doorphone Ring Tone Pattern.

### Programming Manual References

- [115] Extension Ring Tone Pattern
- [706] Doorphone Ring Tone Pattern

### Feature Manual References

- 1.1.108 Ring Tone Pattern Selection

## [435] Local Carrier-based Voice Mail Signaling

Selects the type of signal that the PBX expects to receive from the telephone company's voice mail service. This signal indicates the presence or absence of voice mail messages in the mailbox.

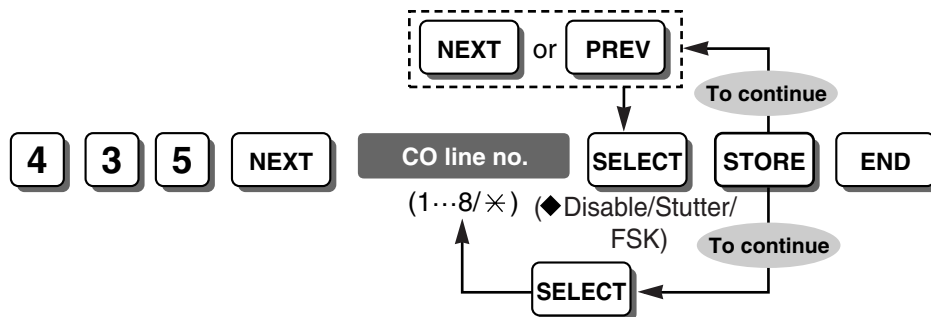

### Feature Manual References

- 1.1.78 Local Carrier-based Voice Mail Service

### [436] Local Carrier-based Voice Mail Access Dial

Specifies the voice mail service access number. This program allows a PT user to access the telephone company's voice mail service when a message is left in the mailbox.

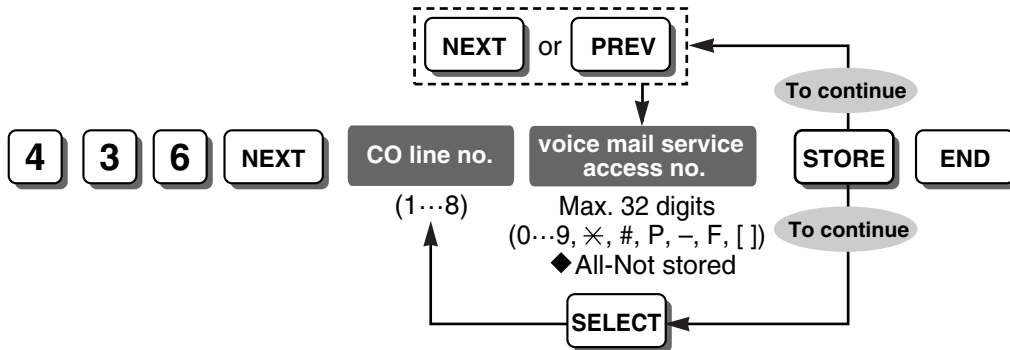

#### Feature Manual References

1.1.78 Local Carrier-based Voice Mail Service

### [437] Extension Access to Local Carrier-based Voice Mail

Selects which extensions can access the voice mail service offered by the telephone company using each outside (CO) line.

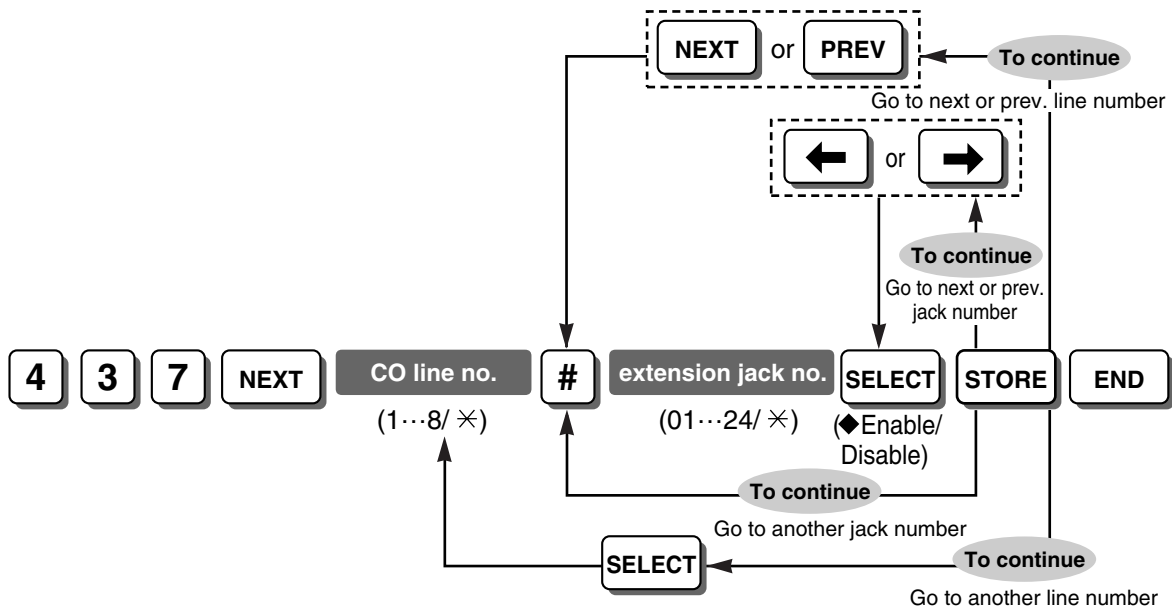

#### Feature Manual References

1.1.78 Local Carrier-based Voice Mail Service

### [438-440] DISA IRNA to BV—Day/Night/Lunch

Selects the common BV OGM used as the intercept destination of unanswered DISA calls in each time service mode.

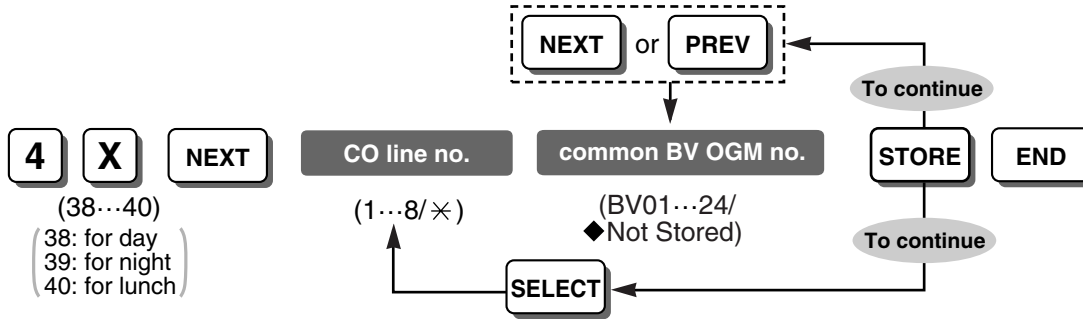

**Feature Manual References**

1.1.8 Built-in Voice Message (BV)

### [500] DISA Incoming Call Dial Mode

Selects the destination of an incoming outside (CO) line call via the DISA feature.

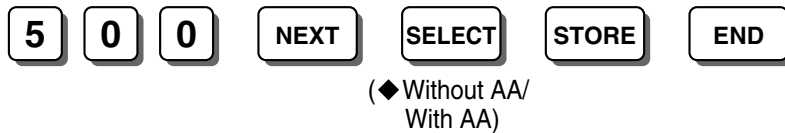

**Notes**

**Without AA:** Available destinations are extension numbers assigned in [009] Extension Number, Outside (CO) Line Access numbers (9, 81 through 88), and the Operator Call number (0)

**With AA:** Available destinations are numbers available in "Without AA" mode and numbers (0 through 9) assigned in [501] DISA Built-in AA

**Programming Manual References**

[009] Extension Number

[501] DISA Built-in AA

**Feature Manual References**

1.1.41 Direct Inward System Access (DISA)

### [501] DISA Built-in AA

Specifies the destinations of the DISA AA numbers.

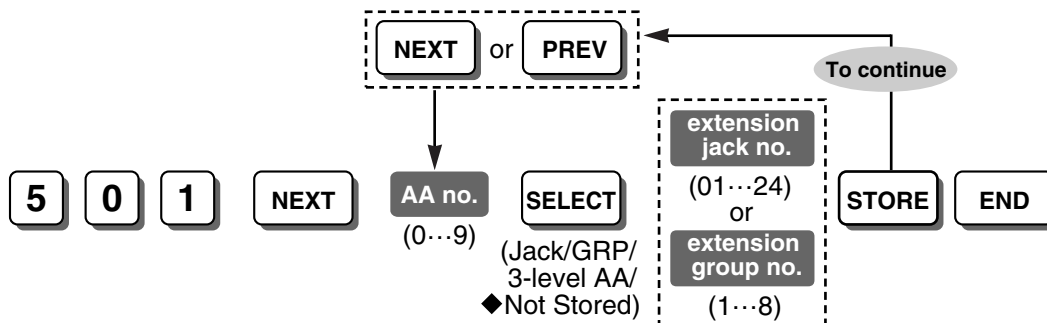

**Conditions**

- This program is available only when "With AA" is selected in [500] DISA Incoming Call Dial Mode.
- If you would like to use the Automatic Line Access number and/or Operator Call number in AA mode, do not assign AA number(s) that correspond to Automatic Line Access or Operator Call numbers (9 and/or 0).

**Programming Manual References**

[500] DISA Incoming Call Dial Mode

**Feature Manual References**

1.1.41 Direct Inward System Access (DISA)

**[503] FAX Connection**

Selects the extension number of the extension to receive fax data when the PBX receives a fax (CNG) tone via the DISA feature.

**Conditions**

- To delete (disable) an extension jack number, press CLEAR in the extension jack number step.
- The assigned extension will automatically have the Data Line Security feature set.

**Feature Manual References**

1.1.41 Direct Inward System Access (DISA)

**[504] DISA Delayed Answer Time**

Selects the length of time the caller hears a ringback tone before hearing a DISA OGM or a short beep.

**Programming Manual References**

[900] Caller ID

**Feature Manual References**

1.1.41 Direct Inward System Access (DISA)

**[505] DISA Wait Time after OGM**

Selects the length of time the PBX keeps detecting DTMF signals or a fax (CNG) tone after completing a DISA OGM.

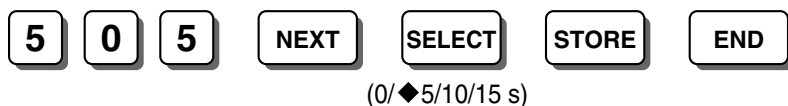
**Programming Manual References**

[408-410] Flexible Ringing—Day/Night/Lunch

[438-440] DISA IRNA to BV—Day/Night/Lunch

[510] DISA No Dial Mode

**Feature Manual References**

1.1.41 Direct Inward System Access (DISA)

**[506] DISA Busy Mode**

Selects how DISA calls are handled when a called extension is busy.

<To select Disconnect or Call Waiting>



(◆Disconnect/  
Call Waiting)

<To select DISA>



(DISA) (1...8)

**Feature Manual References**

1.1.41 Direct Inward System Access (DISA)

1.1.88 Outgoing Message (OGM) for DISA

**[507] DISA Intercept Mode**

Selects how DISA calls are handled when the destination does not answer the call within a preprogrammed time period.



(◆Intercept/  
Disconnect)

**Feature Manual References**

1.1.41 Direct Inward System Access (DISA)

1.1.68 Intercept Routing

1.1.120 Voice Mail APT Integration

1.1.121 Voice Mail Inband (DTMF) Integration

**[508] DISA Ring Time before Intercept**

Selects the length of time until a DISA call is redirected to the intercept destination (Intercept Routing—No Answer feature).



(10/◆20/30/  
40/60/120 s)

**Programming Manual References**

[408-410] Flexible Ringing—Day/Night/Lunch

[438-440] DISA IRNA to BV—Day/Night/Lunch

[507] DISA Intercept Mode

**Feature Manual References**

- 1.1.41 Direct Inward System Access (DISA)
- 1.1.68 Intercept Routing

**[509] DISA Ring Time after Intercept**

Selects the length of time to ring the destination extension when a DISA call is redirected to the intercept destination after the time specified in [508] DISA Ring Time before Intercept expires. When the destination extension does not answer the call within the preprogrammed time period, the call is disconnected.



(10/◆20/30/  
40/60/120 s)

**Programming Manual References**

- [507] DISA Intercept Mode
- [508] DISA Ring Time before Intercept

**Feature Manual References**

- 1.1.41 Direct Inward System Access (DISA)
- 1.1.68 Intercept Routing

**[510] DISA No Dial Mode**

Selects how DISA calls are handled when the PBX does not receive either DTMF (Dual Tone Multi-Frequency) signals or a fax (CNG) tone within a preprogrammed time period.



(◆Intercept/  
Disconnect)

**Feature Manual References**

- 1.1.41 Direct Inward System Access (DISA)

**[511] DISA Security Mode**

Selects the DISA security mode to prevent unauthorized access to the PBX. In Trunk or All security mode, the caller is required to enter a DISA security code.



(◆Trunk/All/  
None Security)

**Notes**

**Trunk Security:** Requires the caller to enter a DISA security code assigned in [512] DISA Security Code before making an outside (CO) line call.

**All Security:** Requires the caller to enter a DISA security code before making either an outside (CO) line or intercom call.

**No Security:** Allows the caller to make either an outside (CO) line or intercom call without entering a DISA security code.

**Programming Manual References**

[512] DISA Security Code

**Feature Manual References**

1.1.41 Direct Inward System Access (DISA)

**[512] DISA Security Code**

Specifies the DISA security codes that must be entered when "Trunk Security" (a DISA security code is required to make an outside (CO) line call) or "All Security" (a DISA security code is required to make an intercom call or outside (CO) line call) is selected in [511] DISA Security Mode.

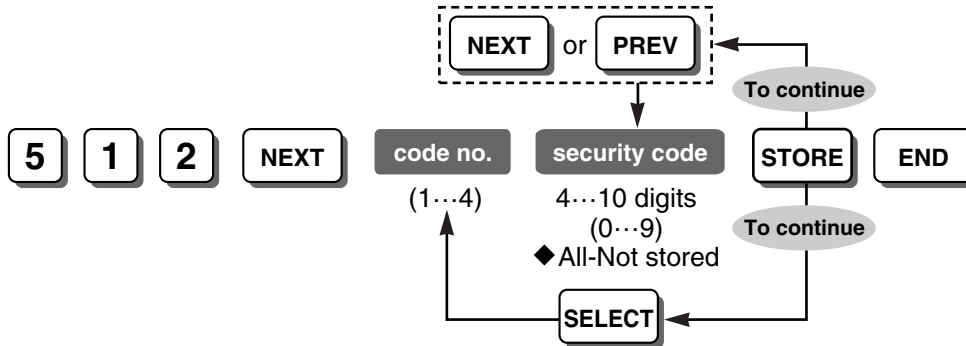

**WARNING**

There is a risk that fraudulent telephone calls will be made using the Outside-to-Outside (CO-to-CO) Line Call feature of DISA.

The cost of such calls will be billed to the owner/renter of the PBX.

To protect the PBX from this kind of fraudulent use, we strongly recommend:

- a) Enabling DISA security (Trunk Security or All Security).
- b) Maintaining the secrecy of passwords.
- c) Selecting passwords that are complex and random, so that they cannot be easily guessed.
- d) Changing passwords regularly.

**Conditions**

- This setting is required if "Trunk Security" or "All Security" is selected in [511] DISA Security Mode.
- Each DISA security code should be unique.
- The number of digits for DISA security codes is selected in [530] DISA Security Code Digits.

**Programming Manual References**

[511] DISA Security Mode

[530] DISA Security Code Digits

**Feature Manual References**

1.1.41 Direct Inward System Access (DISA)

## [513] Cyclic Tone Detection

Selects the number of times the cyclic tone must be detected while the DISA OGM is sent so that the PBX can recognize the end of the DISA call.

**5** **1** **3** **NEXT** **SELECT** **STORE** **END**

(Disable/  
2/3/◆4 times)

### Feature Manual References

1.1.41 Direct Inward System Access (DISA)

## [514] FAX Tone Detection

Selects the number of times the fax (CNG) tone must be detected while the DISA OGM is sent before the PBX recognizes the incoming signal as fax data.

**5** **1** **4** **NEXT** **SELECT** **STORE** **END**

(◆1/2 time(s))

### Programming Manual References

[503] FAX Connection

### Feature Manual References

1.1.41 Direct Inward System Access (DISA)

## [515] Intercept Time for Internal DISA

Selects the length of time the PBX keeps detecting DTMF signals after receiving a call using DISA when no DISA OGM is recorded.

**5** **1** **5** **NEXT** **SELECT** **STORE** **END**

(◆3/6/9 s)

### Programming Manual References

[408-410] Flexible Ringing—Day/Night/Lunch

[438-440] DISA IRNA to BV—Day/Night/Lunch

[510] DISA No Dial Mode

### Feature Manual References

1.1.41 Direct Inward System Access (DISA)

## [516] DISA Incoming Assignment

Enables receiving calls from DISA for each extension.

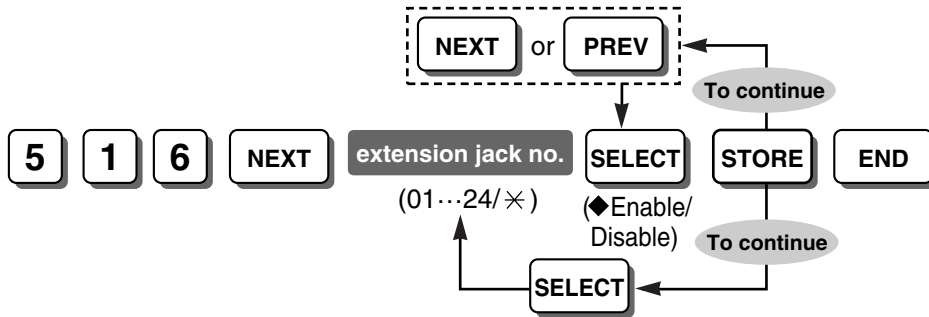

### Feature Manual References

1.1.41 Direct Inward System Access (DISA)

## [517] DISA AA Wait Time

Specifies the length of time after entering a first digit in which the caller must dial the second digit before the DISA AA Service activates.

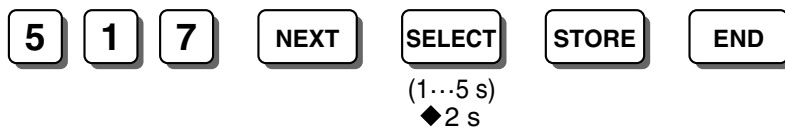

### Conditions

- This program is available only when "With AA" is selected in [500] DISA Incoming Call Dial Mode.

### Programming Manual References

[500] DISA Incoming Call Dial Mode

[501] DISA Built-in AA

### Feature Manual References

1.1.41 Direct Inward System Access (DISA)

## [518] DISA Tone after Security Code

Enables the PBX to send a short beep to the caller when the entered number is the same as one of the DISA security codes.

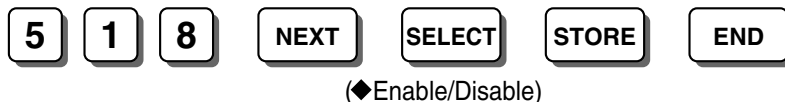

### Programming Manual References

[512] DISA Security Code

### Feature Manual References

1.1.41 Direct Inward System Access (DISA)

### [530] DISA Security Code Digits

Selects the number of digits for the DISA security codes.

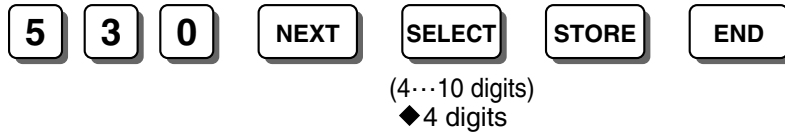

**Conditions**

- When this setting is changed, DISA security codes that have already been assigned in [512] DISA Security Code will be cleared.

**Programming Manual References**

[512] DISA Security Code

**Feature Manual References**

1.1.41 Direct Inward System Access (DISA)

### [531] DISA Ringback Tone

Selects whether to send a ringback tone or Music on Hold to the caller when a DISA call is received.

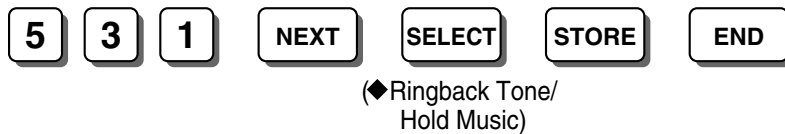

**Feature Manual References**

1.1.41 Direct Inward System Access (DISA)

### [540-549] 3-level AA Assignment

Specifies the destinations of the DISA AA numbers as directed by 3-level DISA OGMs. Depending on the type of destination selected, it may also be necessary to select a specific destination (Extension/Extension Group).

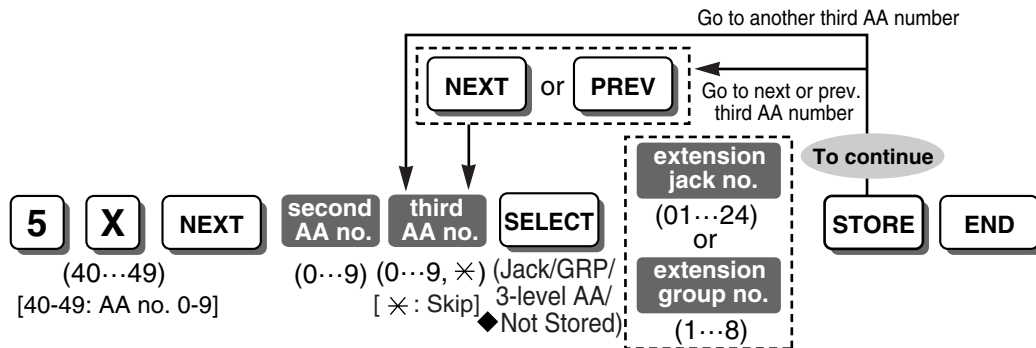

**Conditions**

- This program is available only when "3-level AA" is selected for each AA number in [501] DISA Built-in AA.
- Only when you select "✖" as the third AA number, you can select "3-level AA" in the next step.

**Programming Manual References**

[501] DISA Built-in AA

**Feature Manual References**

1.1.41 Direct Inward System Access (DISA)

**[599] Clear All OGMs of DISA**

Clears all the prerecorded messages (DISA OGMs).



**Feature Manual References**

1.1.88 Outgoing Message (OGM) for DISA

**[600] Extension Group**

Selects the extension group to which the extension belongs.

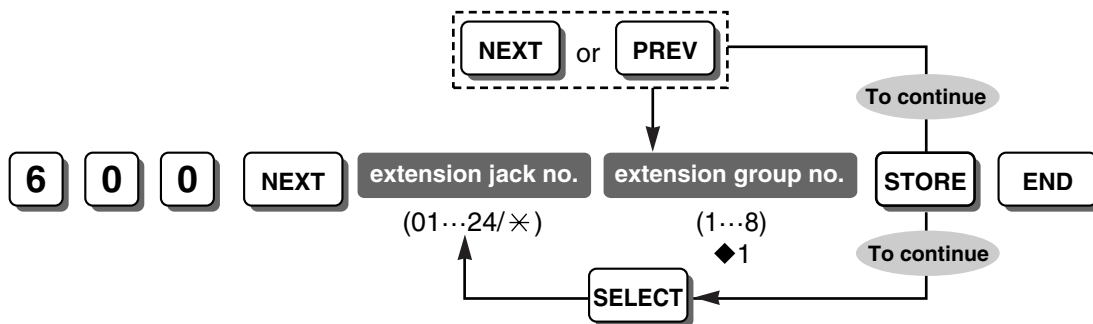

**Feature Manual References**

- 1.1.21 Call Pickup, Group
- 1.1.42 Direct Inward System Access (DISA) Ring
- 1.1.53 Extension Group
- 1.1.67 Idle Extension Hunting
- 1.1.96 Paging—Group

**[601-603] TRS-COS—Day/Night/Lunch**

Selects the TRS COS for each extension, applied to outside (CO) line calls in each time service mode.

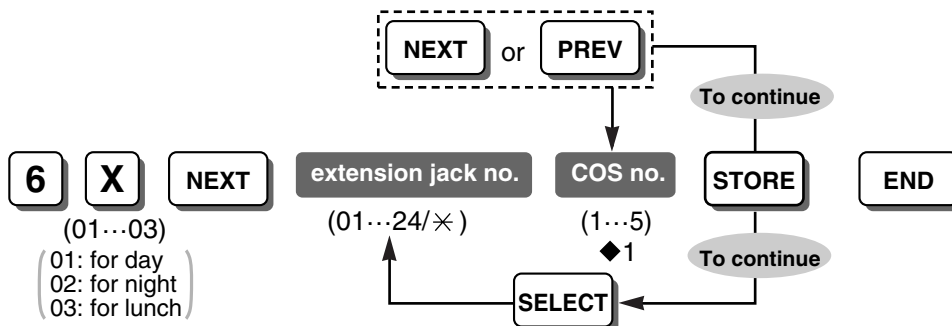

**Feature Manual References**

- 1.1.32 Class of Service (COS)
- 1.1.117 Toll Restriction (TRS)

**[604] Extension Name**

Specifies the names of extensions, to be shown on the display of PTs during intercom calls.

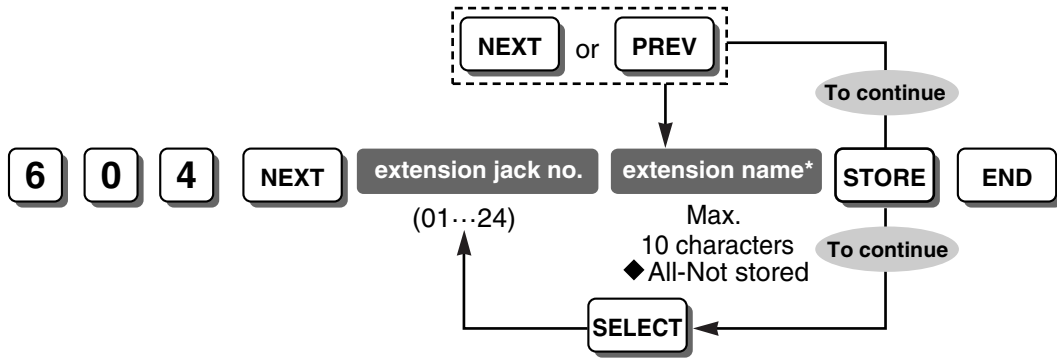

**Conditions**

- \* An extension name can be stored using a PT's dialing buttons. The displayed character varies depending on the number of times that the dialing button is pressed. It is possible to toggle between "Alphabet mode" and "Numeral mode" by pressing SELECT.

**Programming Manual References**

- 2.1 PT Programming—Instructions—Entering Characters
- [009] Extension Number

**Feature Manual References**

- 1.1.43 Display Information
- 1.1.69 Intercom Call

**[605] Account Code Mode**

Selects the account code entry mode for each extension.

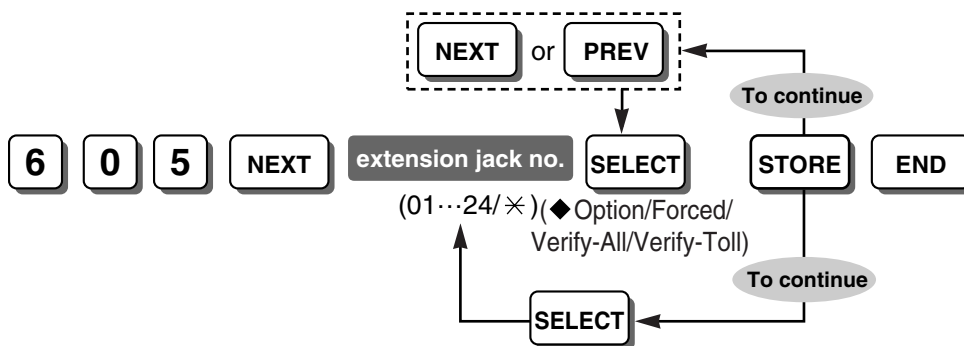

**Programming Manual References**

- [310] Account Code
- [601-603] TRS-COS—Day/Night/Lunch

**Feature Manual References**

- 1.1.2 Account Code Entry
- 1.1.118 Toll Restriction (TRS) Override by Account Code

**[606] Call Transfer to CO Line**

Enables the user to transfer an incoming call to any outside (CO) line.

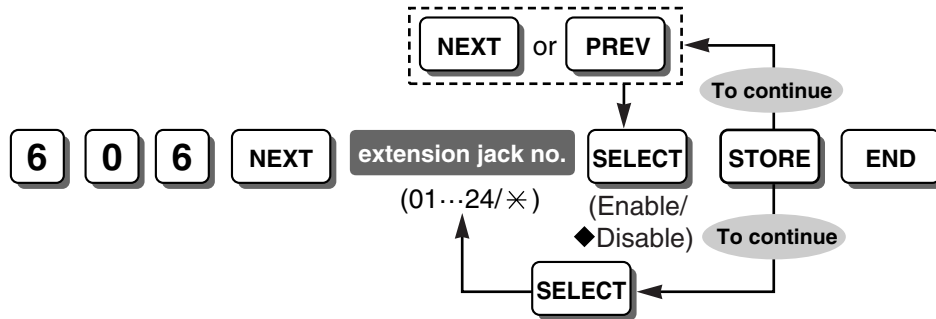

**Feature Manual References**

- 1.1.26 Call Transfer—To Outside (CO) Line
- 1.1.34 Conference, Unattended

**[607] Call Forwarding to CO Line**

Enables the user to forward an incoming call to any outside (CO) line.

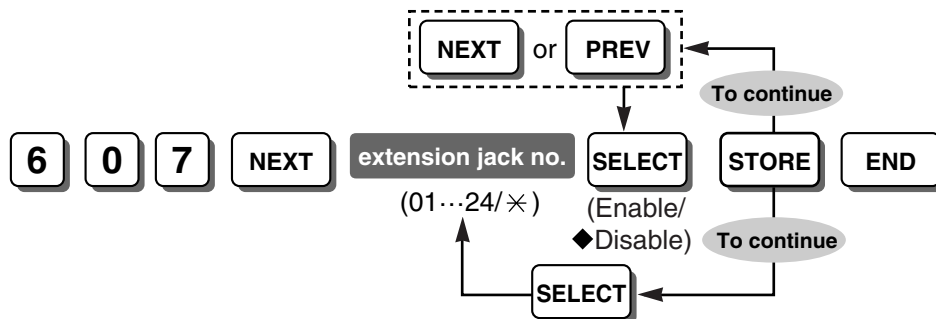

**Feature Manual References**

- 1.1.14 Call Forwarding (FWD)—To Outside (CO) Line

**[608] Executive Busy Override**

Enables the user to interrupt another extension's existing call to establish a 3-party conference call.

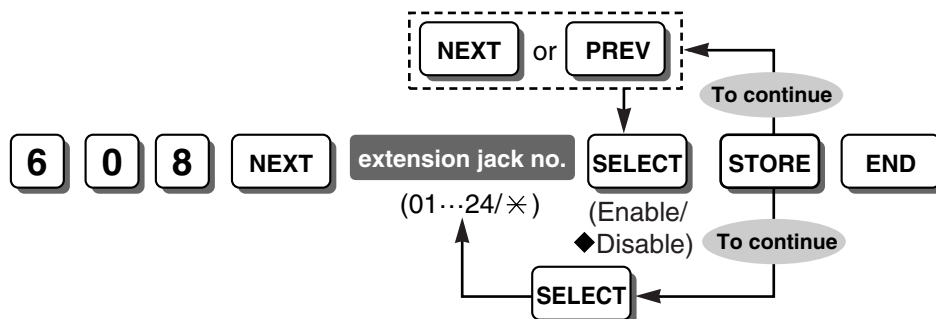

**Feature Manual References**

- 1.1.50 Executive Busy Override—Extension
- 1.1.51 Executive Busy Override—Outside (CO) Line

**[609] DND Override**

Enables the user to make a call to another extension that is in DND mode, by entering the feature number.

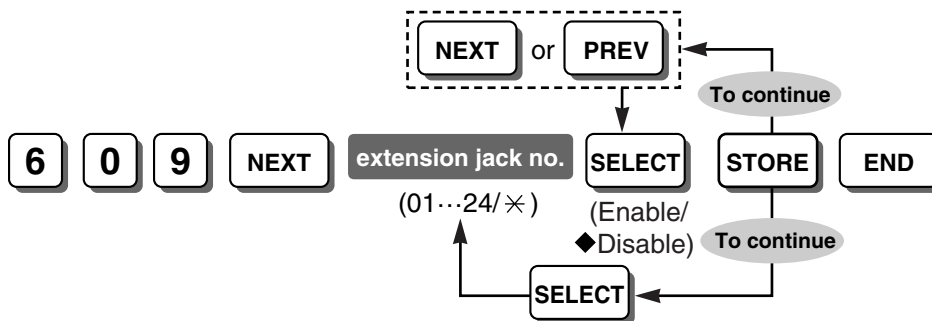

**Feature Manual References**

- 1.1.45 Do Not Disturb (DND) Override

**[610] Paralleled Telephone**

Specifies whether an SLT is connected in parallel with a PT.

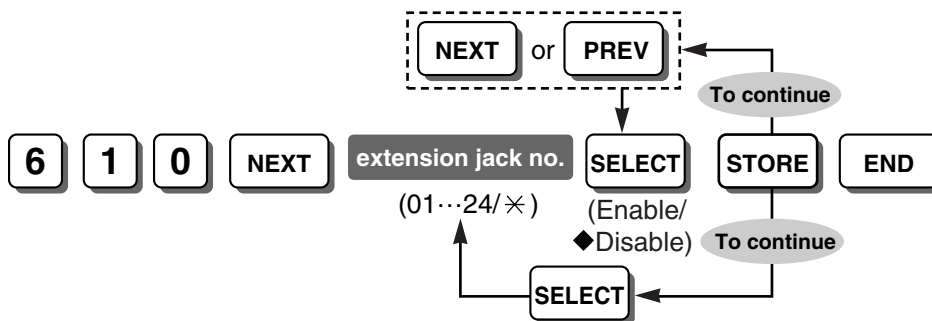

**Feature Manual References**

- 1.1.97 Paralleled Telephone

**[611] TAM Extension**

Specifies whether an extension is connected to a TAM to activate the Call Retrieving from a TAM feature.

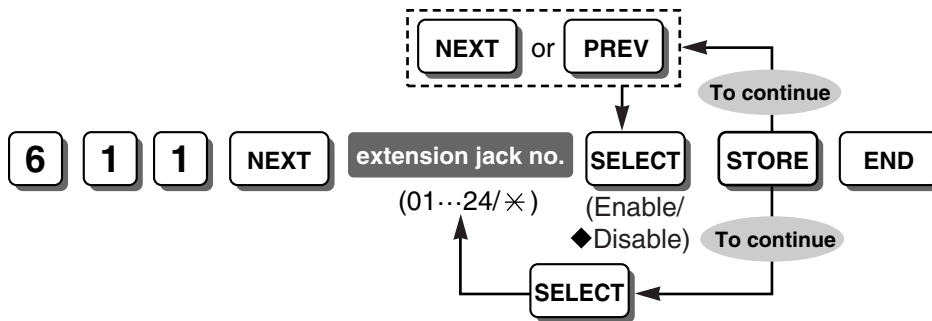

**Feature Manual References**

- 1.1.23 Call Retrieving from a TAM (Telephone Answering Machine)

## [612] Room Monitor

Specifies whether an extension can be monitored using the Room Monitor feature.

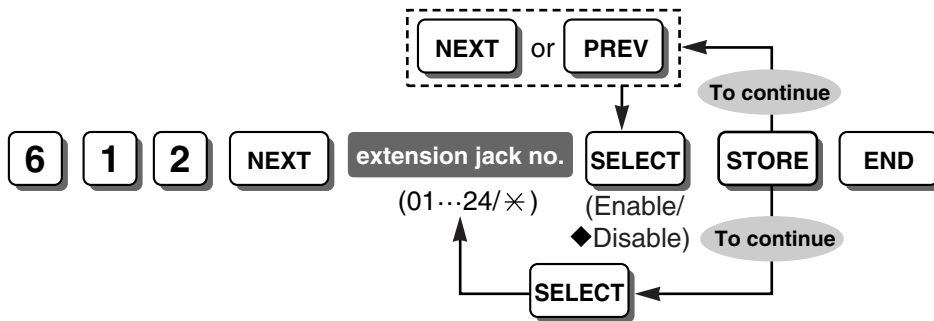

### Conditions

- Extensions that are to be monitored must have their jacks set to "Enable" in this program in advance.

### Feature Manual References

1.1.110 Room Monitor

## [615] LCD Language

Selects the language shown on the display of a PT.

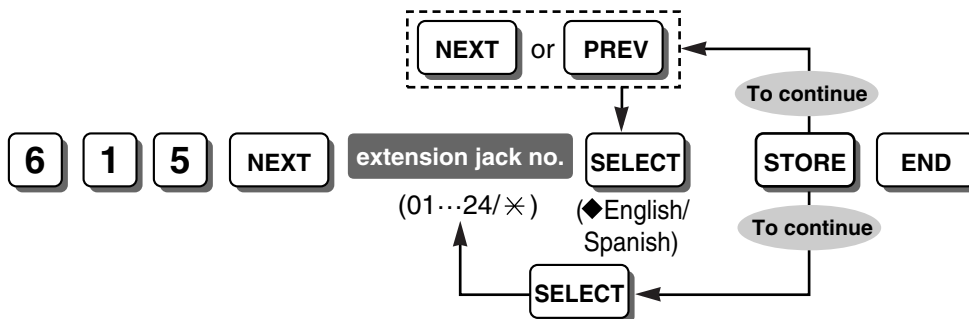

### Feature Manual References

1.1.43 Display Information

## [617] Wireless PT Port Assignment

Identifies whether a Panasonic wireless phone (e.g., KX-TD7895 or KX-T7885) is connected to an extension jack or not.

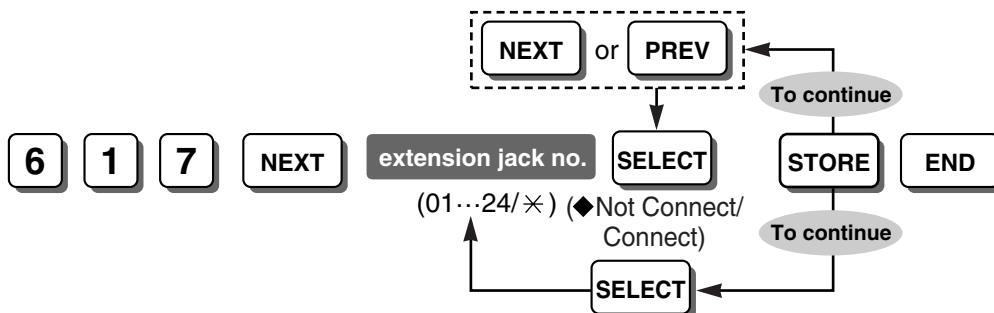

**Conditions**

- If "Connect" is not assigned for the jack that is connected to the Panasonic wireless phone, the wireless phone may function incorrectly.

**[618] Message Waiting for Another Extension**

Specifies whether an extension can use the Message Waiting for Another Extension feature. If this program is disabled, an extension user cannot use a button as a Message for another extension button.

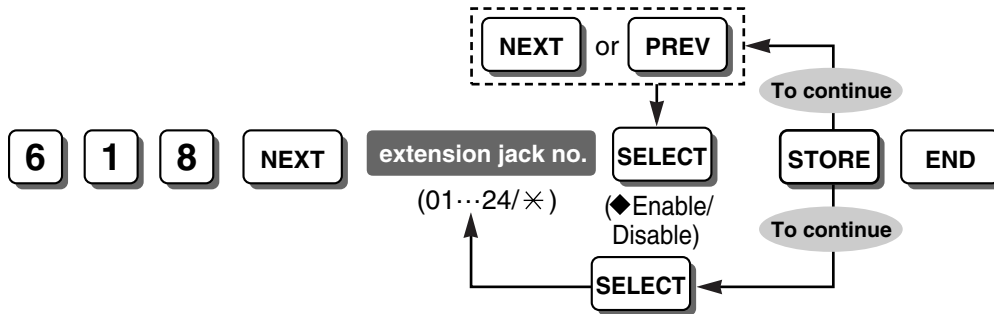

**Feature Manual References**

1.1.83 Message Waiting for Another Extension

**[619] SLT Message Waiting**

Enables the PBX to send dial tone 3 as a message waiting notification to an SLT.

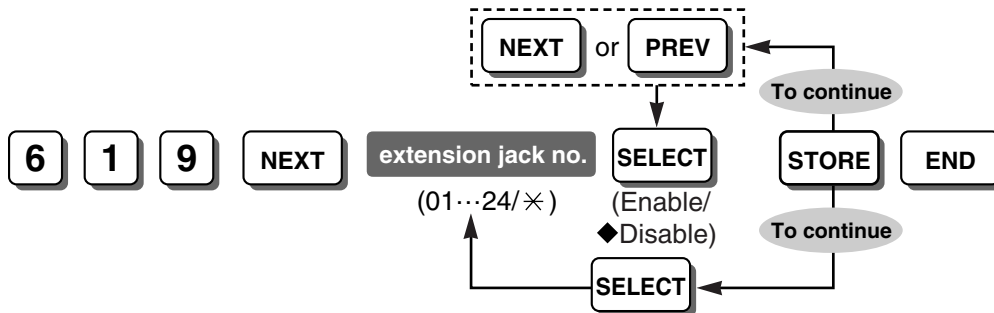

**Feature Manual References**

1.1.82 Message Waiting

**[620] LCS Recording Mode Set**

Selects whether a message will continue being recorded in an extension's mailbox or stop being recorded, when the extension user answer the call while monitoring.

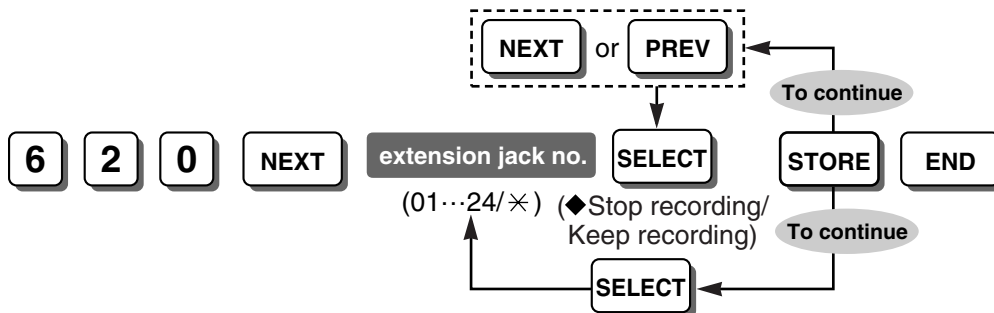

**Feature Manual References**

- 1.1.77 Live Call Screening (LCS) (Voice Mail APT Integration only)
- 1.1.120 Voice Mail APT Integration

**[621] BV Resource**

Selects the BV resource to which the extension belongs.

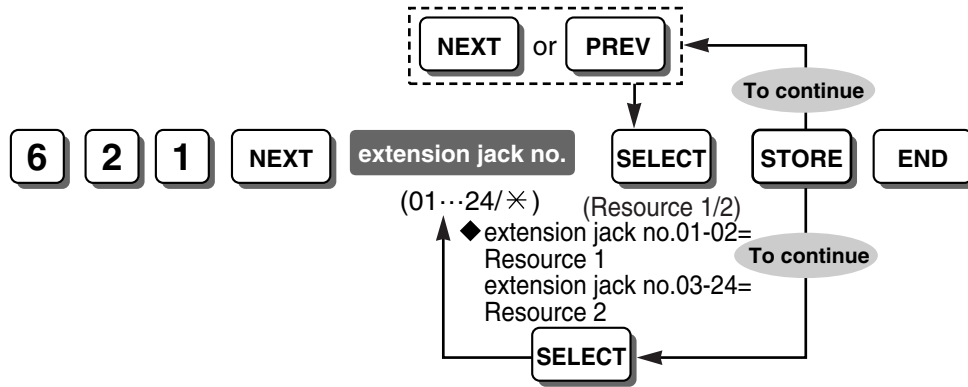

**Feature Manual References**

- 1.1.8 Built-in Voice Message (BV)

**[622] BV for Extension**

Enables the BV feature for each extension.

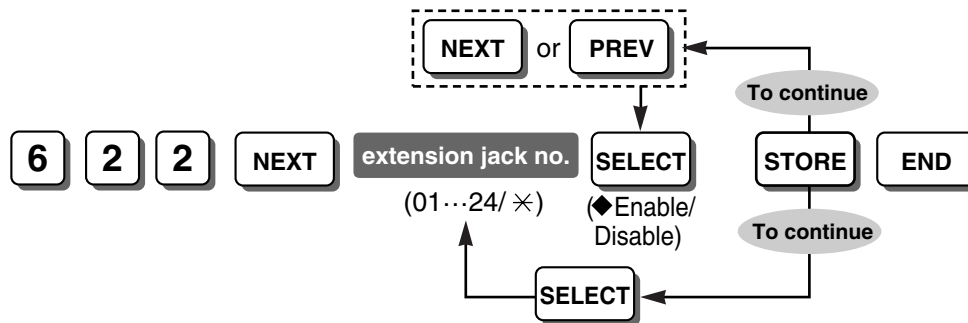

**Feature Manual References**

- 1.1.8 Built-in Voice Message (BV)

## [625] BV Access Code through CO Line

Specifies a voice message access code used to play back and/or erase voice messages through outside (CO) lines.

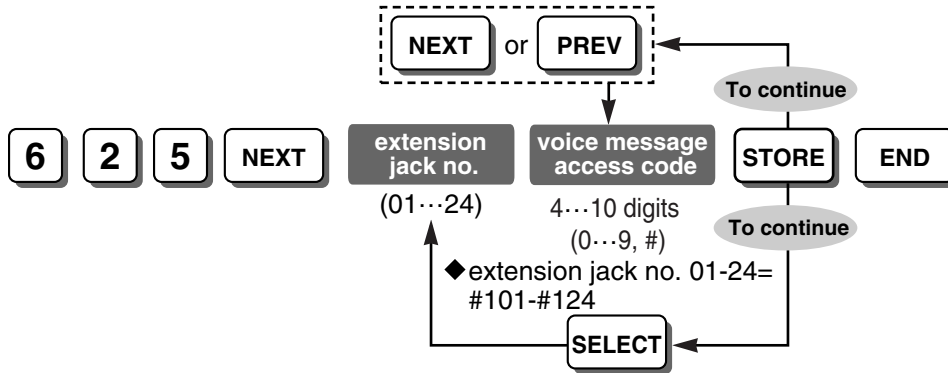

### Conditions

- A voice message access code should be different from the corresponding extension number. If the voice message access code is the same as an extension number, dialing that number will access the extension, not the voice message area.
- A code that starts with a number already assigned as another code cannot be used. For example, if you assign the codes "1234" and "12345", "12345" cannot be selected since "1234" will be recognized first.

### Feature Manual References

1.1.8 Built-in Voice Message (BV)

## [626] BGM Control for APT

Enables the user to turn BGM on and off by dialing "1" while the extension is on-hook and idle.

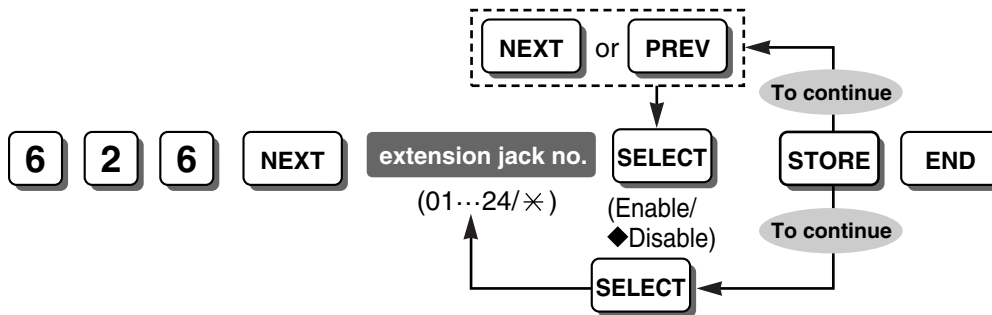

### Feature Manual References

1.1.7 Background Music (BGM)

### [627] SLT Ring Wait Time for New Call

Selects the length of time the ringing for a call is delayed when the call follows immediately after the previous unanswered call. When receiving 2 calls in quick succession, for example, when a call waiting in a queue is directed to an extension immediately after the previous call stops ringing, some SLTs require a pause, after the first call stops ringing, to receive the second call's Caller ID information.

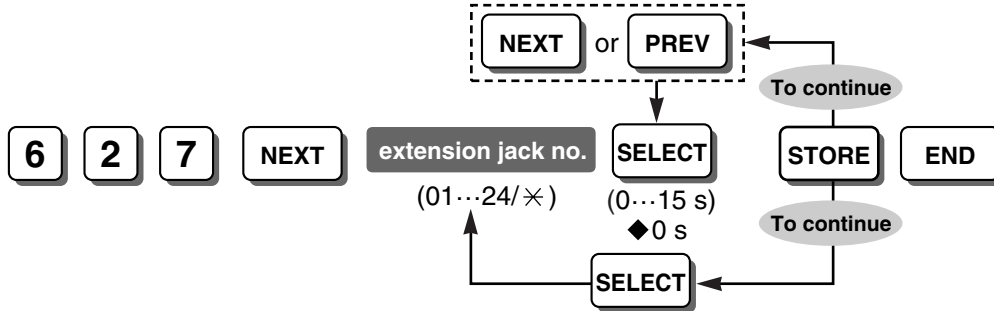

**Feature Manual References**

1.1.30 Caller ID

### [628] SLT Caller ID

Enables the PBX to send Caller ID information to an SLT.

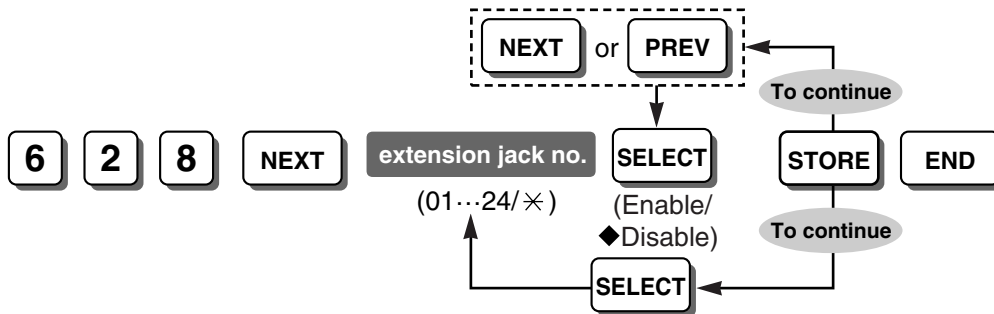

**Feature Manual References**

1.1.30 Caller ID

### [629] SLT Fixed Bell Pattern

Selects the fixed ring tone pattern of an SLT for incoming calls (intercom calls and outside (CO) line calls). The same pattern as used by your telephone company may be selected.

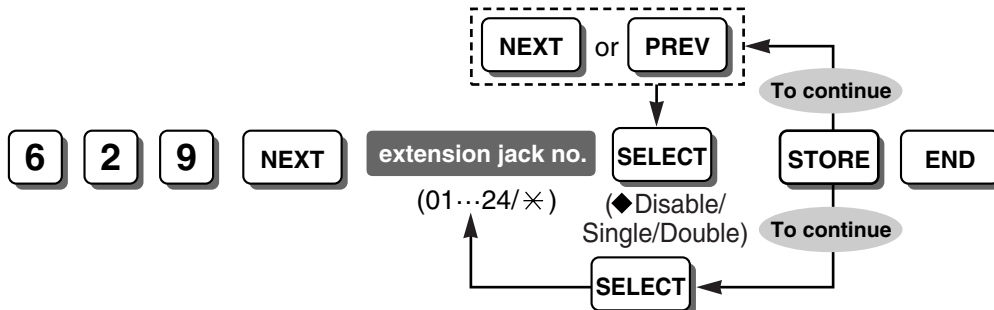

**Feature Manual References**

1.1.30 Caller ID

1.1.108 Ring Tone Pattern Selection

## [700-702] Doorphone Ringing—Day/Night/Lunch

Enables doorphone call reception in each time service mode.

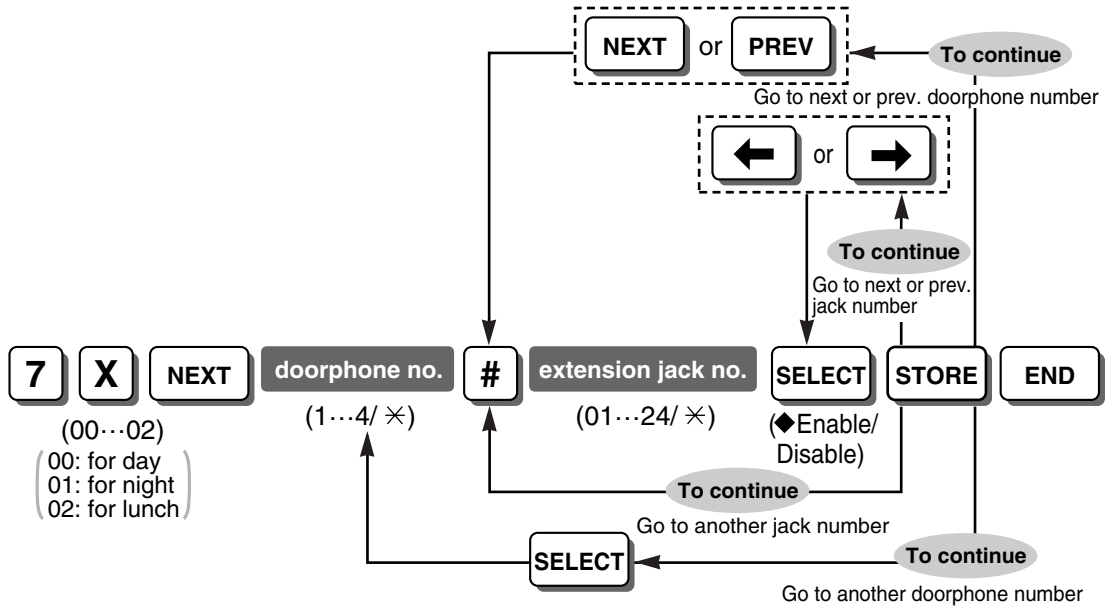

### Feature Manual References

1.1.48 Doorphone Call

## [703-705] Door Opener—Day/Night/Lunch

Enables door opening in each time service mode.

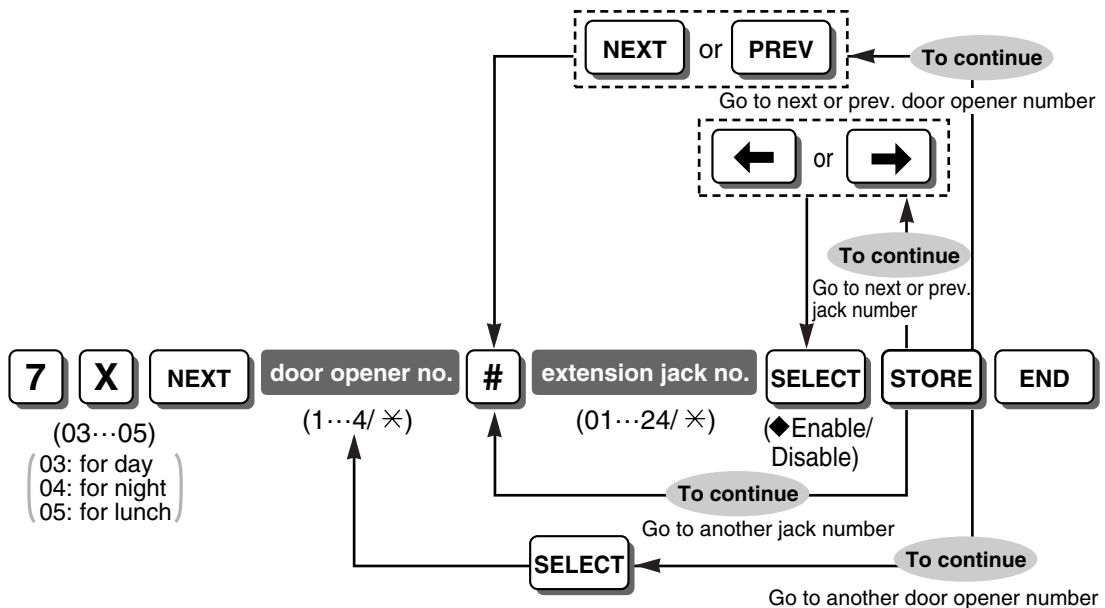

### Feature Manual References

1.1.46 Door Open

## [706] Doorphone Ring Tone Pattern

Selects the ring tone pattern for incoming doorphone calls.

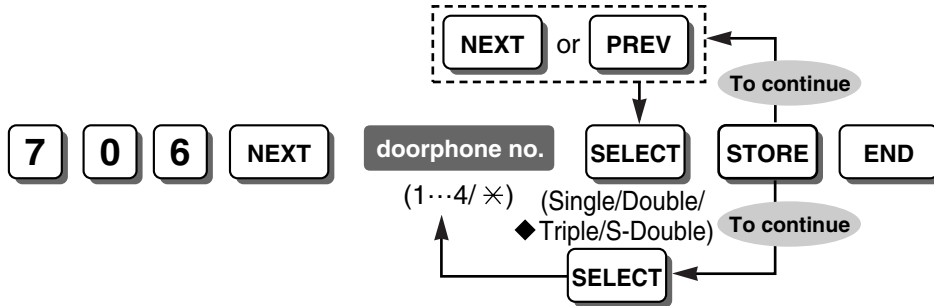

### Conditions

- It is recommended that you set a different ring tone pattern from the ring tone patterns specified in [115] Extension Ring Tone Pattern and [423] CO Line Ring Tone Pattern.

### Programming Manual References

[115] Extension Ring Tone Pattern

[423] CO Line Ring Tone Pattern

### Feature Manual References

1.1.48 Doorphone Call

1.1.108 Ring Tone Pattern Selection

## [707] Doorphone Access Tone

Selects whether the PBX sends a doorphone access tone to a monitored doorphone before monitoring starts.

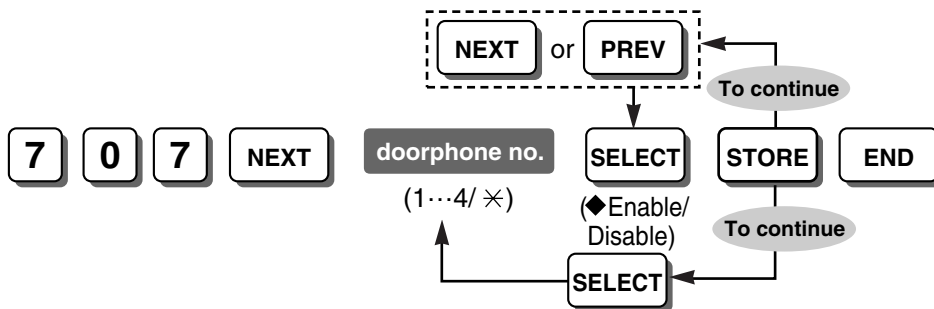

### Feature Manual References

1.1.48 Doorphone Call

1.1.110 Room Monitor

### [708] Doorphone Ring Time

Selects the length of time until the ringing stops and the call is canceled when there is no answer.

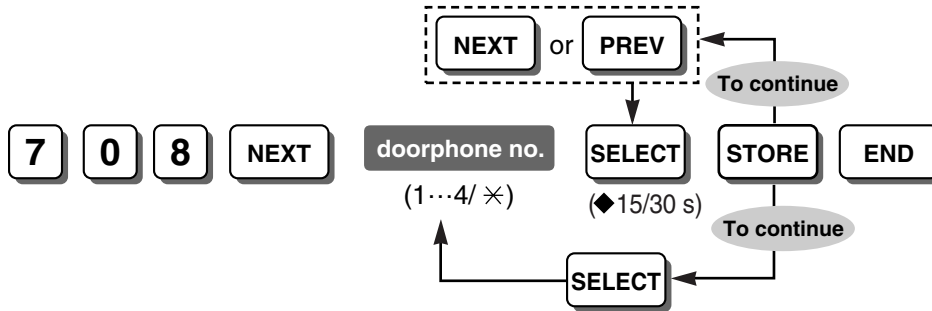

**Feature Manual References**

1.1.48 Doorphone Call

### [709] Door Open Duration

Specifies the length of time the door stays unlocked.

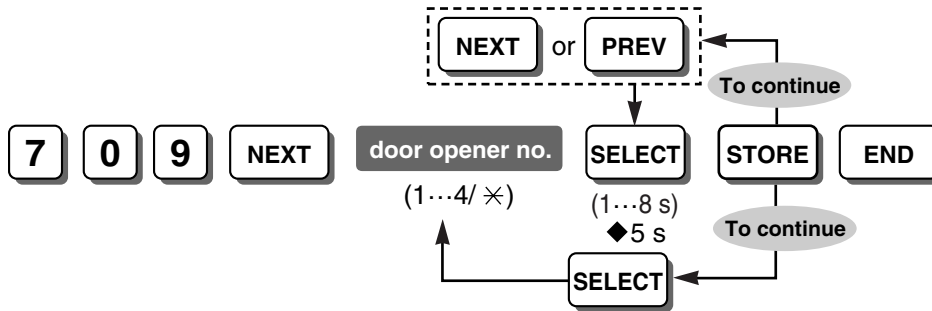

**Feature Manual References**

1.1.46 Door Open

### [710] Doorphone Ring/Chime

Selects whether doorphone calls ring at extensions or at dedicated door chimes.

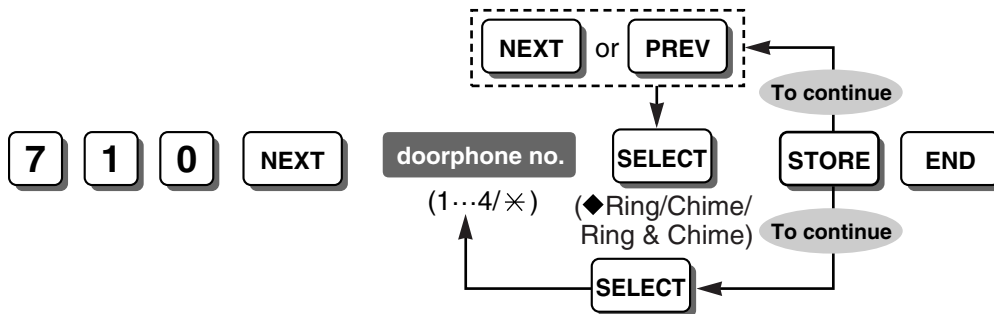

**Programming Manual References**

[700-702] Doorphone Ringing—Day/Night/Lunch

**Feature Manual References**

1.1.47 Doorbell/Door Chime

1.1.48 Doorphone Call

## [711] Doorphone Chime Assignment

Selects the relay to which a doorbell or a door chime is connected, for use when "Chime" or "Ring & Chime" is selected in [710] Doorphone Ring/Chime.

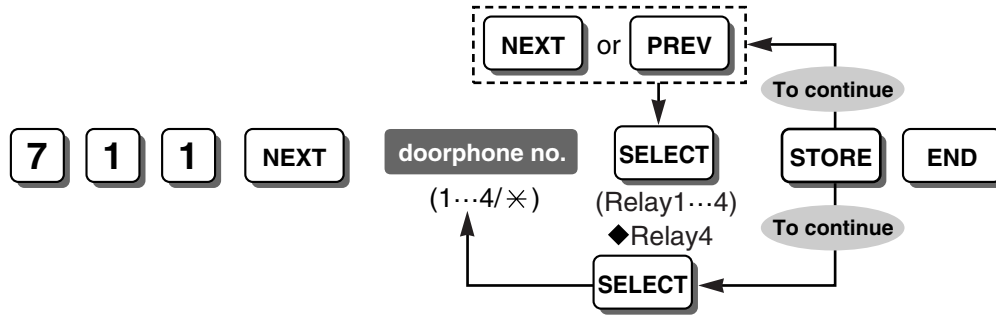

### Conditions

- A relay not connected to a door opener should be selected.

### Programming Manual References

[710] Doorphone Ring/Chime

### Feature Manual References

1.1.47 Doorbell/Door Chime

1.1.48 Doorphone Call

## [712] Doorphone Chime Pattern

Selects the doorphone chime pattern for incoming doorphone calls. Chime patterns 1–4 are played only one time during the doorphone ringing time.

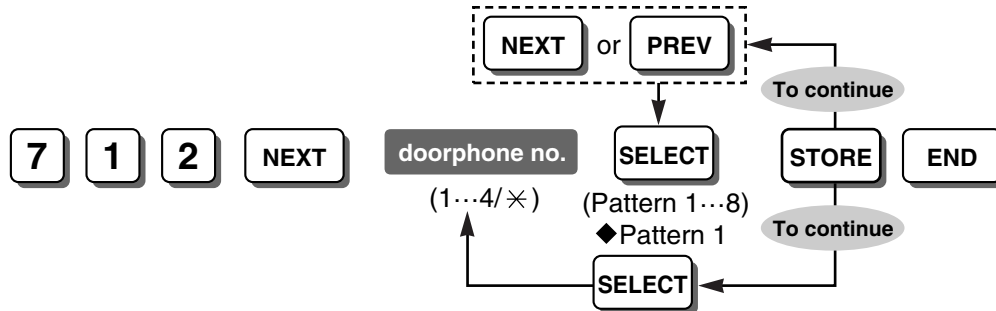

### Feature Manual References

1.1.47 Doorbell/Door Chime

1.1.48 Doorphone Call

2.2.1 Tones/Ring Tones

## [800] SMDR RS-232C Parameter

Specifies the following communication parameters for the Serial Interface (RS-232C port):

- New Line (NL) Code:** Select the code appropriate for the PC or printer. If the PC or printer automatically feeds lines with carriage return, select "CR". If not, select "CR+LF".
- Baud Rate:** Baud rate indicates the transmission speed of data from the PBX to the PC or printer.
- Word Length:** Word length indicates how many bits compose each character.

- d. **Parity Bit:** Parity bit indicates what type of parity is used to detect errors in the string of bits composing a character. Make an appropriate selection depending on the requirements of the PC or printer.
- e. **Stop Bit Length:** Stop bit indicates the end of a bit string that composes a character. Select an appropriate value depending on the requirements of the PC or printer.

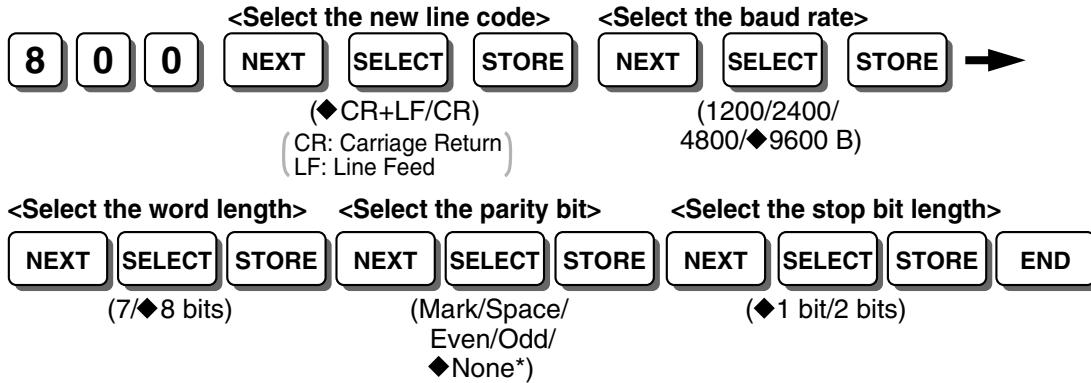

**Conditions**

- \* Select "None" when the printer does not require error checking.
- The following combinations are invalid.

Parity	Word length	Stop bit length
Mark	8	2
Space	8	1
Space	8	2

If any of the above invalid combinations are selected, an alarm tone will be heard.

**Feature Manual References**

1.1.112 Station Message Detail Recording (SMDR)

**[801] SMDR Parameter**

Specifies the following SMDR format parameters in order to match the paper size being used by the printer:

- a. **Page Length:** determines the number of lines per page.
- b. **Skip Perforation:** determines the number of lines to be skipped at the end of every page.

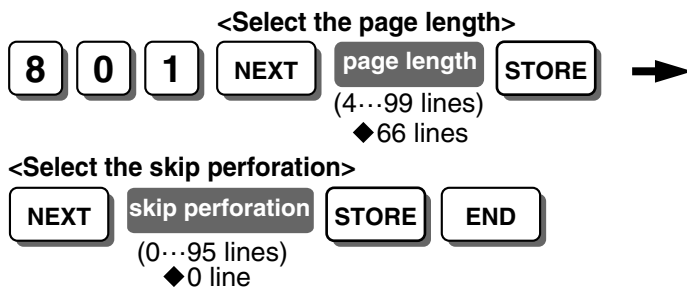

**Feature Manual References**

1.1.112 Station Message Detail Recording (SMDR)

## [802] Incoming/Outgoing Call Selection for Printing

Selects whether the dialed digits of incoming and outgoing outside (CO) line calls are printed.



### Notes

**Outgoing Call:** On (Print all calls)/Off (No printing)/Toll (Print toll calls only)

**Incoming Call:** On (Print all calls)/Off (No printing)

### Programming Manual References

[302-305] TRS—COS 2-5 Denied Code

### Feature Manual References

1.1.112 Station Message Detail Recording (SMDR)

## [803] Secret Number SMDR Print Suppression

Selects whether secret dialing numbers stored in System Speed Dialing or stored in One-touch Dialing buttons are printed with SMDR. Secret dialing numbers are not shown on the displays of PTs, regardless of this setting.

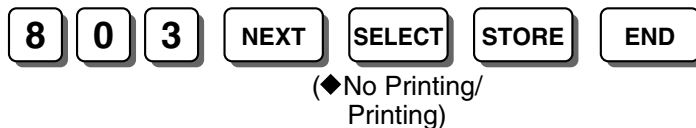

### Programming Manual References

[001] System Speed Dialing Number

### Feature Manual References

1.1.111 Secret Dialing

1.1.112 Station Message Detail Recording (SMDR)

## [804] System Data Dump

Controls whether system programming items that have already been assigned are shown based on the following parameters:

- a. **All para:** All data
- b. **System para:** All data except for "CO para", "Extn. para", "DSS para" and "Speed dial"
- c. **CO para:** The data assigned for each outside (CO) line
- d. **Extn. para:** The data assigned for each extension
- e. **DSS para:** The data assigned on the DSS buttons and PF buttons on the DSS Console
- f. **Speed dial:** The System Speed Dialing numbers and names in [001] System Speed Dialing Number and [011] System Speed Dialing Name
- g. **Stop output:** Not shown

<To select All parameters, System parameter, Speed dial, and/or Stop output>

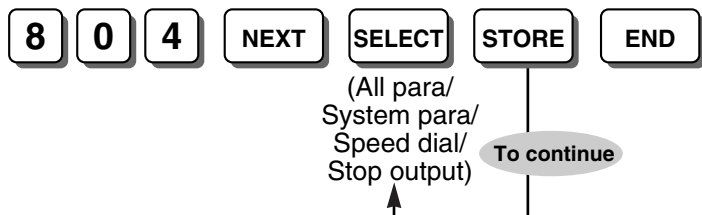

<To select the CO (outside line) parameter>



<To select the Extension parameter>



<To select the DSS parameter>



#### Programming Manual References

[001] System Speed Dialing Number

[011] System Speed Dialing Name

#### Feature Manual References

1.1.112 Station Message Detail Recording (SMDR)

### [805] SMDR Account Code

Selects whether to print out the 4-digit account code (CODE) stored in [310] Account Code or just the 2-digit index of the account code (INDEX) on SMDR.



#### Programming Manual References

[310] Account Code

[605] Account Code Mode

#### Feature Manual References

1.1.2 Account Code Entry

1.1.112 Station Message Detail Recording (SMDR)

1.1.118 Toll Restriction (TRS) Override by Account Code

## [806] SMDR Language

Selects the display language used for SMDR.

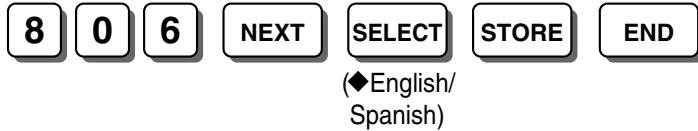

### Feature Manual References

1.1.112 Station Message Detail Recording (SMDR)

## [807] BV Total Recording Time

Selects the total recording time for each BV resource.

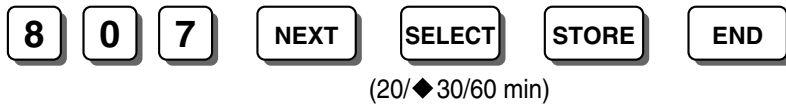

### Conditions

- The recording quality depends on the setting time.  
 20 (min): High; 30: Normal; 60: Low

### Feature Manual References

1.1.8 Built-in Voice Message (BV)

## [808] BV Card Initialization

Initializes the optional BV card installed in the PBX, clearing all messages stored using the BV feature.



### Feature Manual References

1.1.8 Built-in Voice Message (BV)

## [900] Caller ID

Enables the Caller ID feature for each outside (CO) line that has contracted the Caller ID Service from the telephone company.

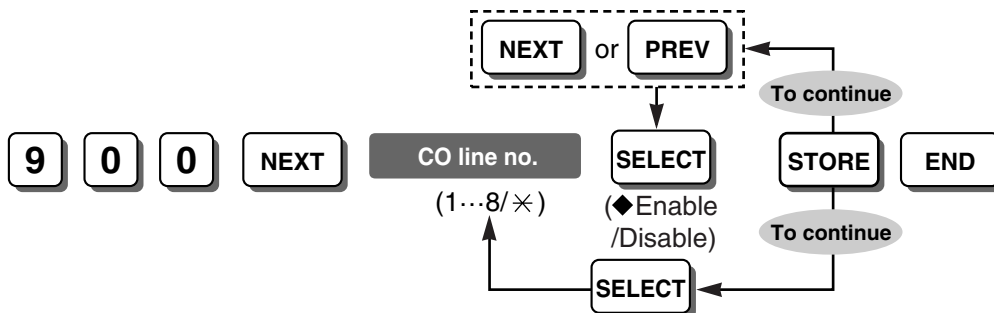

### Conditions

- The DISA Delayed Answer Time for the outside (CO) lines enabled here will always be 6 seconds even if "0 s" or "3 s" is selected in [504] DISA Delayed Answer Time.

**Programming Manual References**

[504] DISA Delayed Answer Time

**Feature Manual References**

1.1.30 Caller ID

**[901] Caller ID Area Code**

Specifies the leading number (area code) that will identify an incoming call as a local call.

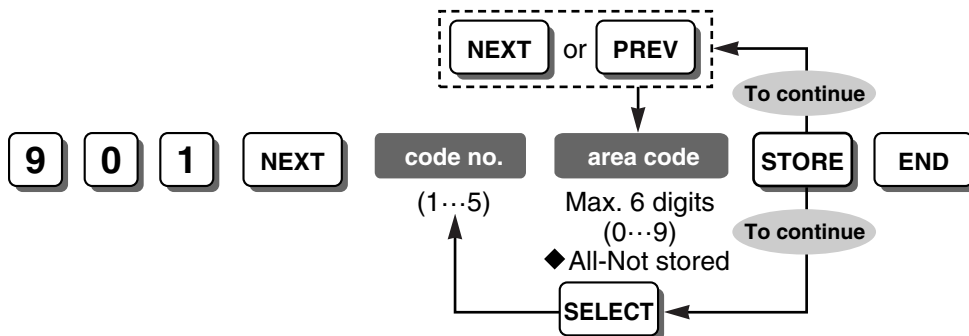

**Programming Manual References**

[902] Caller ID Modification for Local Calls

**Feature Manual References**

1.1.18 Call Log, Incoming

1.1.30 Caller ID

**[902] Caller ID Modification for Local Calls**

Selects the number of digits to be removed from the beginning of the incoming caller's number and the number to be added in place of the removed digits for local calls.

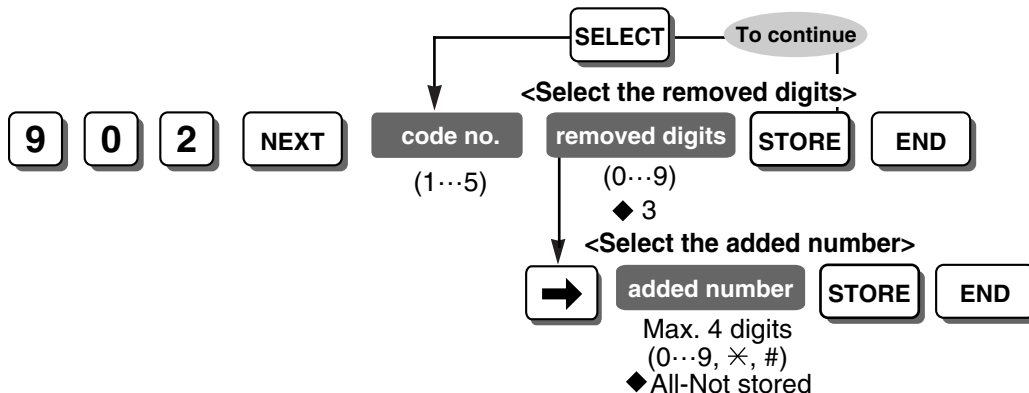

**Programming Manual References**

[901] Caller ID Area Code

**Feature Manual References**

1.1.18 Call Log, Incoming

1.1.30 Caller ID

## [903] Caller ID Modification for Long-distance Calls

Selects the number of digits to be removed from the beginning of the incoming caller's number and the number to be added in place of the removed digits for long-distance calls.

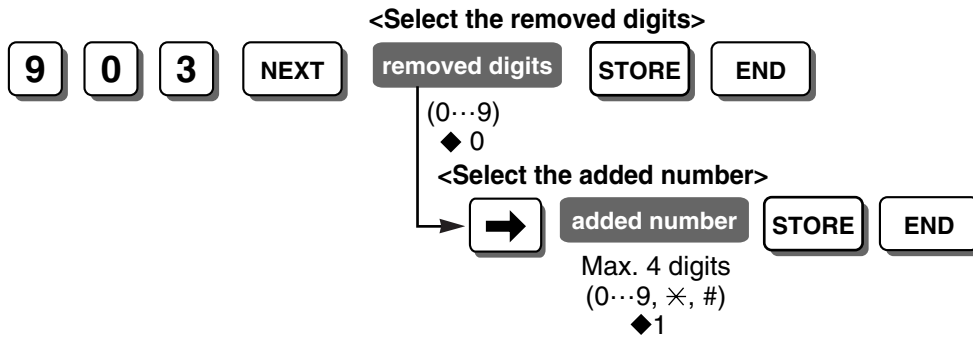

### Feature Manual References

- 1.1.18 Call Log, Incoming
- 1.1.30 Caller ID

## [904] Caller ID Log Priority

Selects which caller information is shown first on the display of the PT.

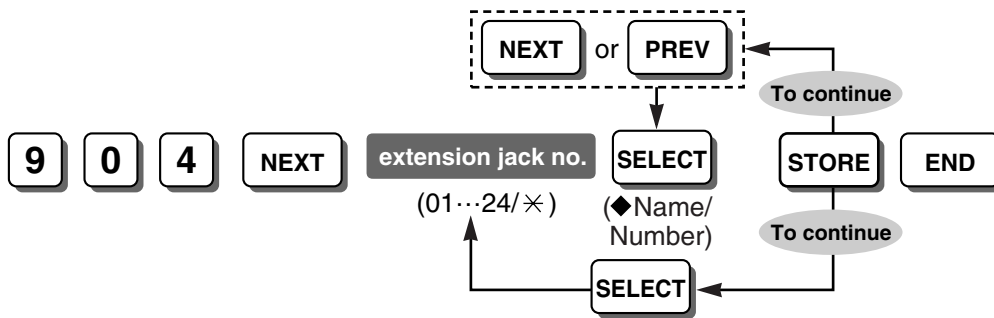

### Conditions

- This program is available when the Caller ID service provides both a name and a number. If only the number is provided, this program is not necessary.

### Feature Manual References

- 1.1.18 Call Log, Incoming
- 1.1.30 Caller ID
- 1.1.43 Display Information

## [906] Caller ID SMDR Format

Selects whether a caller's telephone number is printed out on SMDR or not.

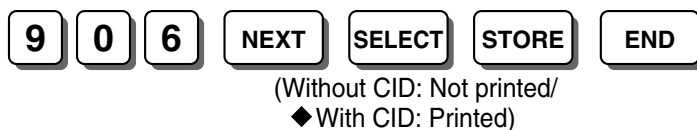

### Conditions

- Even if a name is also sent by the Caller ID service, only the number is printed.

**Feature Manual References**

- 1.1.30 Caller ID
- 1.1.112 Station Message Detail Recording (SMDR)

**[907] Caller ID SMDR Printout**

Enables the PBX to display a caller's telephone number on SMDR before the call is answered.

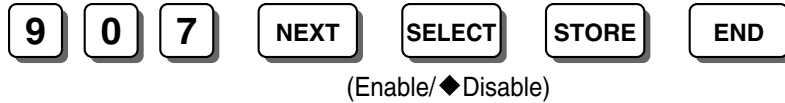

**Feature Manual References**

- 1.1.30 Caller ID
- 1.1.112 Station Message Detail Recording (SMDR)

**[908] Call Waiting Caller ID Time**

Selects the length of time that the Call Waiting Caller ID feature sent from the telephone company is shown on the display of a PT.

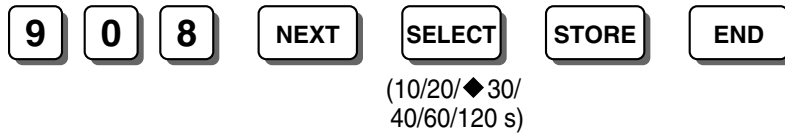

**Conditions**

- The TRANSFER button, HOLD button, and CONF button do not function during the assigned time.

**Feature Manual References**

- 1.1.28 Call Waiting Caller ID

**[909] Common Area Call Log Check**

Specifies whether an extension can view call logs stored in the common area. If this program is enabled, the Caller ID Indication—Common button and Caller ID Selection—Common button can be assigned.

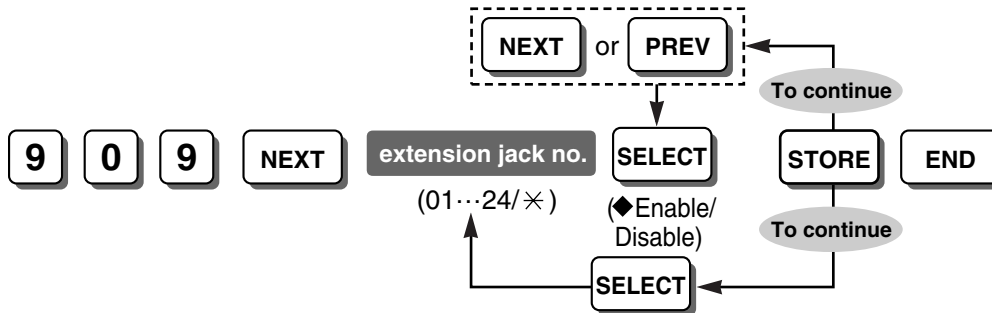

**Feature Manual References**

- 1.1.18 Call Log, Incoming

## [913] Call Waiting Caller ID Assignment

Enables the Call Waiting Caller ID feature for each outside (CO) line that has had Caller ID Service contracted from the telephone company.

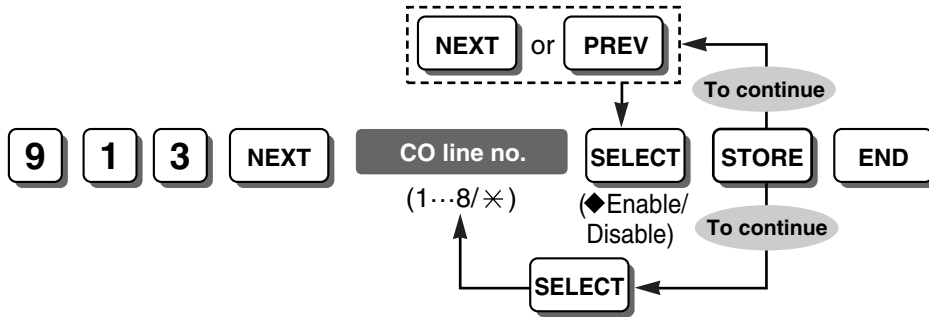

### Conditions

- When the Caller ID feature is disabled in [900] Caller ID, the Call Waiting Caller ID feature does not function even if it is enabled here.

### Programming Manual References

[900] Caller ID

### Feature Manual References

1.1.28 Call Waiting Caller ID

## [914] Call Waiting Caller ID CAS Receive Time

Selects the allowable CAS (CPE [Customer Premise Equipment] Alerting Signal) duration. Normally, it should not be necessary to change the default setting.

If the extension user has a Call Waiting Caller ID during a conversation, the telephone company will send an alert tone (CAS) to the PBX. If the CAS duration is too long or too short, the CAS is ignored by the PBX. If the CAS is accepted, then the PBX will respond and the Call Waiting Caller ID feature will be performed.

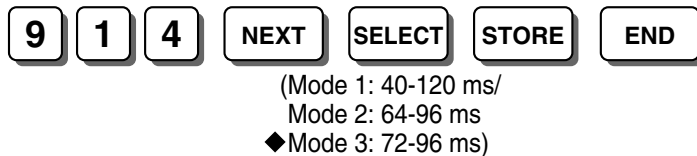

### Conditions

- This program is available when the Caller ID and Call Waiting Caller ID features are enabled in [900] Caller ID and [913] Call Waiting Caller ID Assignment.

### Programming Manual References

[900] Caller ID

[913] Call Waiting Caller ID Assignment

### Feature Manual References

1.1.28 Call Waiting Caller ID

## [915] Caller ID Checksum

Enables or disables selection of the checksum mode. Normally, it should not be necessary to change the default setting.

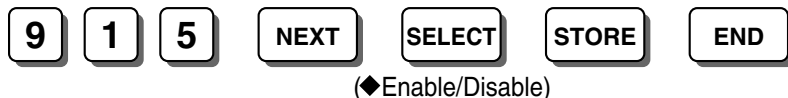

### Feature Manual References

- 1.1.28 Call Waiting Caller ID
- 1.1.30 Caller ID

## [963] Call Forwarding Selection

Enables the PBX to forward the calls received on outside (CO) lines programmed as "Normal" in [414-416] CO Line Mode—Day/Night/Lunch. If this program is disabled, outside (CO) line calls cannot be forwarded even if the extension user has set the FWD feature.

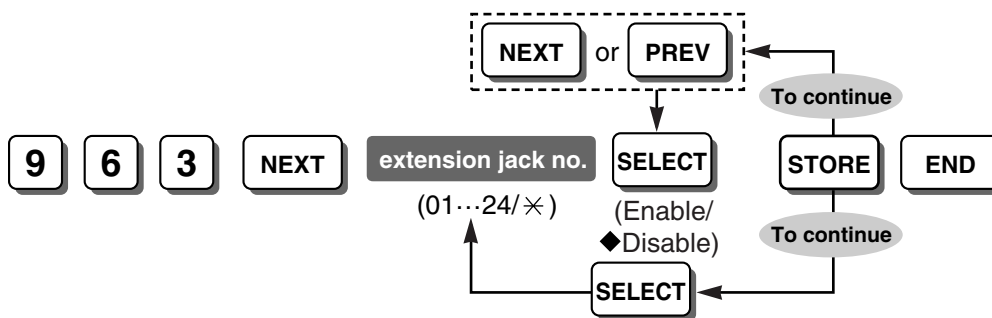

### Conditions

- This program also functions for outside (CO) line calls via the DISA Intercept Routing feature, and when DISA calls are received by a DISA ring group.

### Programming Manual References

[414-416] CO Line Mode—Day/Night/Lunch

### Feature Manual References

- 1.1.11 Call Forwarding (FWD)—All Calls
- 1.1.12 Call Forwarding (FWD)—Busy/No Answer
- 1.1.13 Call Forwarding (FWD)—Follow Me

## [966] TRS Check after Answering

Specifies whether the PBX checks DTMF signals when answering calls or not.

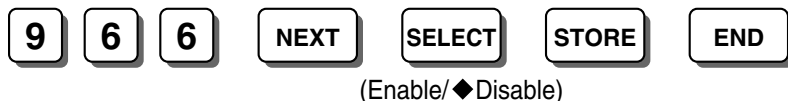

## [967] TRS Check Time after Answering

Specifies the length of time that the DTMF signal is checked when "Enable" is selected in [966] TRS Check after Answering.

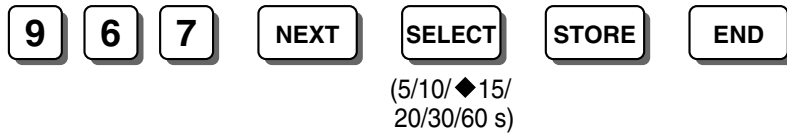

### Programming Manual References

[966] TRS Check after Answering

## [968] KX-T7700 Series Incoming Lamp Control

Enables the Message/Ringer Lamp on the KX-T7700 series telephones for the following incoming calls:

- a. Incoming call from an outside (CO) line with Caller ID information
- b. Incoming call from another extension to a busy extension when the called extension has set Call Waiting (Call Waiting Tone 1)
- c. Incoming doorphone call whose ring tone pattern is set to "S-Double" in [706] Doorphone Ring Tone Pattern (except when using the Paralleled Telephone feature) when an optional doorphone or doorbell/door chime is connected to the PBX

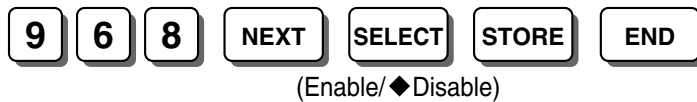

### Programming Manual References

[706] Doorphone Ring Tone Pattern

### Feature Manual References

- 1.1.27 Call Waiting
- 1.1.28 Call Waiting Caller ID
- 1.1.47 Doorbell/Door Chime
- 1.1.48 Doorphone Call
- 1.1.82 Message Waiting
- 1.1.83 Message Waiting for Another Extension

## [998] Firmware Version

Used to confirm the ROM and the firmware version of the PBX alternately by pressing SELECT.

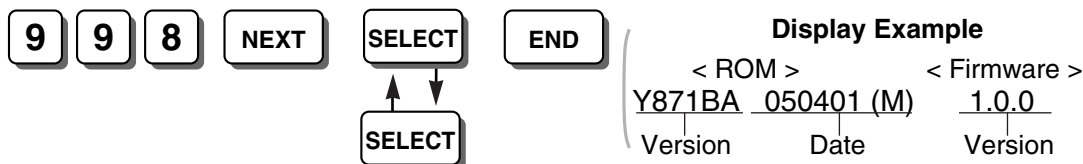

### Programming Manual References

[804] System Data Dump

### Feature Manual References

1.1.58 Firmware Upgrade

## [999] System Data Clear

Clears preprogrammed system data. The PBX will restart with the default settings.

<To select All parameters, System parameter, and/or Speed dial>

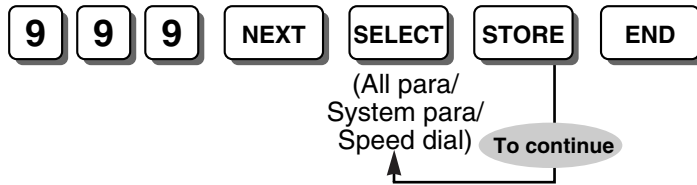

<To select the CO (outside line) parameter>



<To select the Extension parameter>



<To select the DSS parameter>



### Conditions

- Please refer to [804] System Data Dump for each parameter.

### Programming Manual References

[804] System Data Dump

### Feature Manual References

1.1.103 PT Programming



---

## **Section 3**

# ***PC Programming—Introduction***

*This section serves as reference operating instructions when using the KX-TA Maintenance Console software to program the PBX.*

## 3.1 Introduction

Maintenance Console allows you to perform system setup and maintenance of the PBX, KX-TA824. The types of operations that can be performed with Maintenance Console are as follows:

- Backing up and restoring system data
- Viewing and modifying system settings
- Upgrading the firmware of the PBX
- Resetting the PBX, and clearing set values
- Initializing the BV message card, and clearing all OGMs stored for DISA

## 3.2 PC Programming

### 3.2.1 Installing and Starting KX-TA Maintenance Console

To program and administer the PBX by PC (Personal Computer), you need to install KX-TA Maintenance Console onto the PC. To install and start KX-TA Maintenance Console when the PC and the PBX are connected, refer to the Installation Manual (→ 3.1.1 Installing KX-TA Maintenance Console on a PC). KX-TA Maintenance Console starts the program using the drive where you installed the software automatically.

### System Requirements

#### Operating System

- Microsoft® Windows® 98 SE, Windows Me, Windows 2000, or Windows XP

#### Hardware

- CPU: 300 MHz Intel® Celeron® or faster
- RAM: At least 128 megabytes (MB) of available RAM
- Hard disk space: At least 100 MB of space for the installation, and approximately 2 MB of additional space for user files.

## 3.3 Software Modes

Maintenance Console has 3 modes of operation: Initial mode, Batch mode and Interactive mode.

- Initial mode  
This is the state of the software when no system data is open for modification, and the PC is not currently communicating with the PBX. The software enters this mode if launched without connecting to the PBX.
- Batch mode  
Batch mode allows you to create new system data files, and make modifications to system data files stored on your PC, without being connected to the PBX. The edited system data files can be uploaded to the PBX later using Interactive mode. To enter Batch mode, select an option from the **File** menu.
- Interactive mode  
Interactive mode allows you to directly modify the system data and settings stored in the PBX's memory from a PC that is connected to the PBX. Data can be modified and results displayed in real time. In addition, when no system data setting windows are open, maintenance operations

such as firmware upgrade can be performed. To enter Interactive mode, check the **Connect to PBX** box on the password entry window when starting up Maintenance Console, or select an option from the **Connect** menu.

When a new window is opened and the relevant data is downloaded from the PBX, that data is cached temporarily in the PC. To reduce data transfer times, when the same window is reopened within the same programming session (without disconnecting the PC from the PBX), the cached data is used.

The table below shows which options can be accessed from each mode.

Certain options in each mode are only available when one or more system data setting windows are open, or no windows are open.

The letter "A" indicates the state where no windows are open.

The letter "B" indicates the state where one or more windows are open.

Menu	Submenu	Initial Mode	Batch Mode		Interactive Mode	
			A	B	A	B
File	New	✓	✓	✓		
	Open	✓	✓	✓		
	Close		✓	✓		
	Save		✓	✓		
	Save As		✓	✓		
	File Transfer PC to PBX				✓	
	File Transfer PBX to PC				✓	
	Program List		✓	✓	✓	✓
	Print			✓		✓
	Print ALL		✓	✓		
	[Recent Files]	✓	✓	✓		
Exit	✓	✓	✓	✓	✓	
Connect	Connect	✓				
	Disconnect				✓	✓
	Profile Setup	✓	✓	✓	✓	✓

Menu	Submenu		Initial Mode	Batch Mode		Interactive Mode	
				A	B	A	B
View	Tool Bar		✓	✓	✓	✓	✓
	Programmer Code Change	Installer Level	✓	✓	✓	✓	✓
		User Level	✓	✓	✓	✓	✓
	Screen Customize		✓	✓	✓	✓	✓
	System Data Setting Menu			✓	✓	✓	✓
Utility	Firmware Upgrade					✓	
	Quick Setup					✓	
	System Reset	Normal				✓	
		Default				✓	
	System Data Clear					✓	
	DISA OGM Clear					✓	
	BV Card Initialization					✓	
Window	Cascade				✓		✓
	Tile Horizontally				✓		✓
	Tile Vertically				✓		✓
Help	Help		✓	✓	✓	✓	✓
	About		✓	✓	✓	✓	✓

## 3.4 Status Bar

The status bar is the bar at the bottom of the Maintenance Console window that displays information on the current state of the Maintenance Console software.

The information displayed is as follows, in order from left to right:

Area	Values	Description
Software Mode	Initial Mode Batch Mode xxxx Interactive Mode	See 3.3 Software Modes. In Batch Mode, the current system data file name is shown in place of “xxxx”.

Area	Values	Description
Firmware Version	Ver x.x.x xxxxxxxxxxxx (e.g., Ver 1.0.0 Y591AA030519)	Displays the version number of the PBX software. The numbers following are the ROM version and the date of creation.
PBX Model Code	M	Displays the model code assigned to the PBX.

## 3.5 Access Levels

There are 2 main levels of access to the Maintenance Console software: Installer and User.

Installer-level users can view and edit all settings, in addition to choosing the options and screens available to User-level users, through the 7.3 Screen Customize option in the **View** menu.

It is necessary to enter the Installer-level password to log on to Maintenance Console at Installer level. However, User level access may or may not require a password, depending on whether one has been set in **Programmer Code Change**. (See 7.2 Programmer Code Change)

Access to menu options within Maintenance Console also depends on the current software mode (See 3.3 Software Modes).

The target users for each access level are as follows:

Level	Use
User	For end users
Installer	For dealers or system installers

## 3.6 Standard Buttons

There are several standard buttons that are displayed on most screens within Maintenance Console, and perform the same function on each screen.

The standard buttons are as follows:

Button	Function
OK	Implements changes and closes the current screen.
Cancel	Abandons changes and returns to the previous screen.
Apply	Implements changes and remains on the same screen.
Help	Displays the relevant help topic for the current screen.



---

## **Section 4**

# ***PC Programming—Opening Screen***

*This section describes the options available when starting Maintenance Console.*

## 4.1 Software Modes

Every time Maintenance Console is started, a dialog box will appear. From here, you can enter any of the 3 available software modes.

### To start Maintenance Console in Initial mode

1. Enter the relevant programmer code (User or Installer level).
2. Click **OK**.  
Maintenance Console will start.

### To start Maintenance Console in Batch mode

1. Enter the relevant programmer code (User or Installer level).
2. Click **OK**.  
Maintenance Console will start.
3. Select an option from the **File** menu.
  - Select **New** to create a new system data file.
  - Select **Open** to open an existing system data file.

### To start Maintenance Console in Interactive mode

1. Enter the relevant programmer code (User or Installer level).
2. Select the **Connect to PBX** check box.  
Connection options will be displayed.
  - To use a previously saved profile, select the **Use profile** check box. When no profiles have been saved, this check box is not available. Select the desired profile from the list.
3. In **Enter System Password**, enter the password used to log on to the PBX.  
If the system password for the PBX has been stored with the profile, it will be entered automatically.
4. Select the method of connecting to the PBX.
5. If necessary, click the **Setup** button to modify connection parameters. See the tables below for more details.  
This option is not available when a profile has been selected.
6. Click **OK**.
  - The **OK** button is only available when a valid system password has been entered.

Maintenance Console will start, and automatically connect to the PBX. If this is the first time that Maintenance Console has connected to the PBX, and the date and time of the PBX have not yet been set, the Quick Setup wizard will run. For more details, see 8.2 Quick Setup.

### Connection parameters for RS-232C

Parameter	Values	Explanation
Port	COMx	Specify the number of the COM port assigned to the PC's RS-232C interface. Only available COM ports will be displayed.
Baud Rate (bps)	9600	Displays the speed of data transmission. This value cannot be changed.

Parameter	Values	Explanation
Word Length	8 bits	Displays the number of bits in a word. This value cannot be changed.
Stop Bit	1 bit	Displays the length of the stop, used to identify the end of a transmitted group of bits. This value cannot be changed.
Parity Bit	None	Displays the kind of parity error-checking used. This value cannot be changed.

When connecting the KX-TA Maintenance Console to the PBX using an RS-232C cable, assign the following values to the Serial Interface (RS-232C) port of the PBX:

Baud Rate (bps): 9600

Word Length: 8 bits

Parity Bit: None

Stop Bit: 1 bit

#### Connection parameters for Modem

Parameter	Values	Explanation
Dial Number	0-9, *, #, "-" (hyphen) and "," (comma)	Telephone number to be dialed to access the PBX.
Dial Type	Auto (Tone), Auto (Pulse), Manual	Outgoing dialing method. If "Manual" is selected, a telephone must be connected in parallel to dial.
Comment	–	Enter a comment to help to identify this profile.
Port	COMx	Specify the number of the COM port assigned to the PC's modem interface. Only available COM ports will be displayed.
Baud Rate (bps)	1200, 2400, 4800, 9600, 19200, 38400, 57600, 115200	Specify the speed of data transmission.
Flow Control	None, Hardware	Specify whether the rate of data transfer is managed by hardware or not.
Modem Initialize	Default, Custom	Specifies the command used to initialize the modem. If "Custom" is selected, enter the initialize string in the text box. Refer to your modem's instruction manual for more details.
Initialize	–	Click to send the specified initialize string to the modem.



---

## **Section 5**

# ***PC Programming—File***

*This section explains the File menu, which lets you work with system data files, and view programming items.*

## 5.1 New

Creates a new system data file, used to program the PBX in Batch mode. All settings are in their initial or default state.

To upload the file created here to the PBX, see 5.6 File Transfer PC to PBX.

### **Notes**

Since selecting this option creates an empty system data file, uploading this file to the PBX will overwrite all previous settings. Use with care.

### **To create a new system data file**

- From the **File** menu, select **New**.

If a system data file is already open, a window will be displayed to save the current file.

- Click **Yes** to save the current system data and create a new file.  
If the current system data has not previously been saved, the **Save As** dialog box will be displayed. See 5.5 Save As for more information.
- Click **No** to discard the current system data and create a new file.
- Click **Cancel** to return to the current system data without creating a new file.

## 5.2 Open

Opens a system data file previously saved on the PC, and enters Batch mode.

To upload a file modified here to the PBX, see 5.6 File Transfer PC to PBX.

### **To open a system data file**

1. From the **File** menu, select **Open**.
  2. Navigate to the folder containing the system data file you want to open.
  3. Select the file.
  4. Click **Open**.
- If the file is not supported by the PBX (e.g., a system data file from an incompatible PBX), it will not be opened, and a warning message will be displayed. The only files that can be opened are files that were created by KX-TA Maintenance Console.
    - Click **OK** to return to the main screen.

## 5.3 Close

Closes the system data file that is currently being modified in Batch mode, and returns to Initial mode.

### **To close a system data file**

- From the **File** menu, select **Close**.

If the system data file has not been saved, a confirmation message will be displayed, giving you the option to save the file.

- Click **Yes** to save the file.
- Click **No** to abandon the changes.

- Click **Cancel** to return to the previous screen.

## 5.4 Save

Overwrites the previously saved system data file with the system data currently being modified in Batch mode.

To upload a file saved here to the PBX, see 5.6 File Transfer PC to PBX.

### To save a system data file

- From the **File** menu, select **Save**.

If the data has never been saved, the **Save As** dialog box will be displayed. (See 5.5 Save As.)

## 5.5 Save As

Saves the system data file being modified in Batch mode with the name chosen by the user.

To upload a file saved here to the PBX, see 5.6 File Transfer PC to PBX.

### To save a system data file with a new name

1. From the **File** menu, select **Save As**.
2. Navigate to the folder in which you want to save the file.
3. Enter a file name, or select a file to overwrite.
4. Click **Save**.

If choosing to overwrite another file, a warning message will be displayed. Click **Yes** to overwrite, or **No** to return to the previous screen.

## 5.6 File Transfer PC to PBX

Restores or uploads previously saved system data to the PBX.

Files that can be transferred with this option are those that were saved using 5.4 Save, 5.5 Save As, or 5.7 File Transfer PBX to PC.

This option is intended for use when the data stored in the PBX has been lost due to system crash or other reason, or large-scale edits have been made to the data in Batch mode. Choosing this option will overwrite any previous settings in the PBX. Use with care.

### To transfer system data to the PBX

1. From the **File** menu, select **File Transfer PC to PBX**.
2. Navigate to the folder containing the system data file you want to open.
3. Select the file.
4. Click **Open**.
  - If the data contained within the file is not suitable for the PBX, a message will be displayed and the display will return to the main screen.

The system data file will be transferred to the PBX. A progress indicator displays the current progress. Once started, the operation cannot be canceled. When complete, a message will be displayed.

5. Click **OK**.

## 5.7 File Transfer PBX to PC

Creates a backup file containing all PBX system data on the PC. Once saved, this file can be edited in Batch mode using 5.2 Open, if required.

### To backup system data to the PC

1. From the **File** menu, select **File Transfer PBX to PC**.
2. Navigate to the folder in which you want to save the file.
3. Enter a file name, or select a file to overwrite.
4. Click **Save**.

The system data will be transferred to the PC. A progress indicator displays the current progress.

- To cancel the operation, click **Cancel** at any time.

When complete, a message will be displayed.

5. Click **OK**.

## 5.8 Program List

Displays a searchable list of PT programming numbers [XXX], feature numbers (XX...), and personal programming [PT Personal]. Allows direct access to the relevant screen within Maintenance Console.

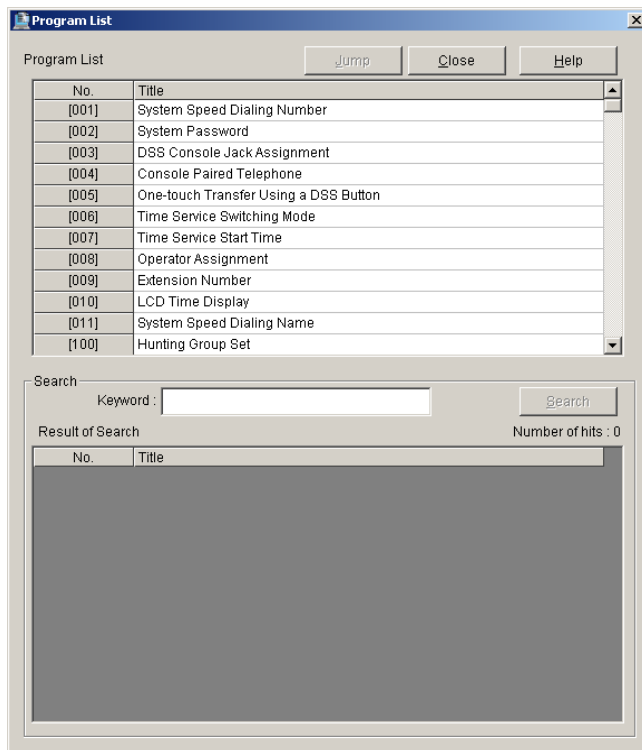

### To view programming topics

1. From the **File** menu, select **Program List**.

A list of all PT programming numbers, feature numbers and personal programming is displayed in numerical order.

- Click the **No.** or **Title** cell to reorder the list.
  - Enter a text string in the **Keyword** box and click **Search** to display all matching programming topics.
  - Double-click a specific programming title in either of the lists, or click it and then click **Jump**, to go directly to the relevant Maintenance Console screen.
2. Click **Close** to close the window.

## 5.9 Print

Prints the system data contained in the currently active screen.

The system data in each screen is printed according to that screen's preset output format.

### To print the active screen data

1. From the **File** menu, select **Print**.
2. From the drop-down list, select the desired printer.
3. Click **Print**.

## 5.10 Print ALL

Prints all system data, except for that contained in the **9.1.1 Date & Time [1-1]** screen.

The total number of pages to be printed is displayed at the bottom of the window.

The system data in each screen is printed according to that screen's preset output format.

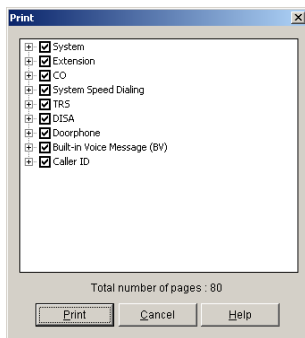

### To print system data from multiple screens

1. From the **File** menu, select **Print ALL**.  
A list of the system data screens will be displayed in outline view.  
By default, all system data is selected for printing.
  - Click the plus sign to expand an item.
  - Click the minus sign to collapse a previously expanded item.
  - Clear the check boxes of screens you do not want to print.
2. Click **Print**.
3. From the drop-down list, select the desired printer.

4. Click **Print**.

# 5.11 Exit

Closes Maintenance Console.

### To exit Maintenance Console

1. From the **File** menu, select **Exit**.  
A confirmation message will be displayed.
2. Click **Yes**.
  - In Batch mode, if the system data file being modified has not been saved, a message will be displayed, giving you the option to save the file.
    - Click **Yes** to save the file.
    - Click **No** to abandon the changes.
    - Click **Cancel** to return to the previous screen.
  - In Interactive mode, if the system data being modified has not been transmitted to the PBX, a message will be displayed, giving you the option to transmit the data.
    - Click **Yes** to transmit the data.
    - Click **No** to abandon the changes.
    - Click **Cancel** to return to the previous screen.

The software will exit.

---

## **Section 6**

# ***PC Programming—Connect***

*This section describes the Connect menu, which offers options for connecting a PC to the PBX.*

## 6.1 Connect

Connects the PC to the PBX.

There are 3 ways to connect the PC to the PBX: RS-232C, USB, and modem.

This option allows direct entry of connection parameters, for cases where the PC is used to connect to one or just a few PBXs, and an individual profile for each PBX is not necessary. If you connect to multiple PBXs and would prefer to choose from among pre-saved profiles instead, see 6.3 Profile Setup for more details about creating profiles.

When connecting to the PBX for the first time, the Quick Setup utility will run automatically. For more details, see 8.2 Quick Setup.

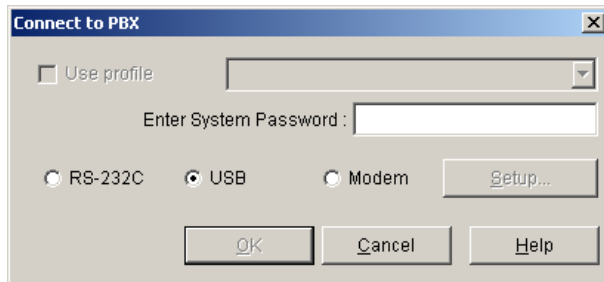

### To connect to the PBX by RS-232C

1. From the **Connect** menu, select **Connect**.

The **Connect to PBX** window will be displayed.

2. Select a connection option.

- Select the **Use profile** check box if you want to use a pre-saved profile. This option is only available when one or more profiles have been previously stored.
  - a. Select the profile to use from the drop-down list.  
The **Setup** button will become unavailable.
  - b. If the system password for the PBX has not been stored with the profile, enter it.  
If the system password has been stored with the selected profile, it does not need to be entered.
- Select the **RS-232C** radio button if you want to enter the parameters manually.
  - a. Enter the system password for the PBX.
  - b. Click **Setup**.

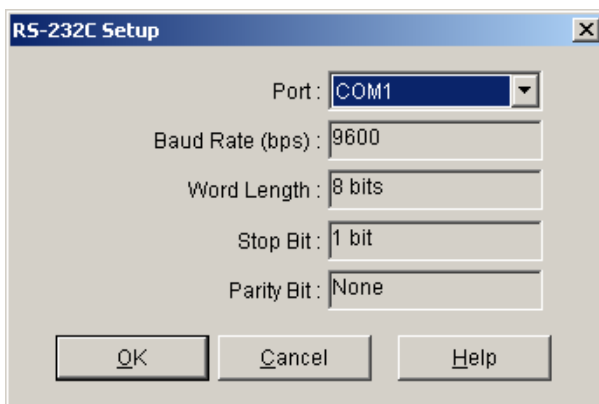

- c. Specify the COM port as required. For more details, see the table below.
- d. Click **OK**.

3. Click **OK**.

The parameters are as follows:

Parameter	Values	Explanation
Port	COMx	Specify the number of the COM port assigned to the PC's RS-232C interface. Only available COM ports will be displayed.
Baud Rate (bps)	9600	Displays the speed of data transmission. This value cannot be changed.
Word Length	8 bits	Displays the number of bits in a word. This value cannot be changed.
Stop Bit	1 bit	Displays the length of the stop, used to identify the end of a transmitted group of bits. This value cannot be changed.
Parity Bit	None	Displays the kind of parity error-checking used. This value cannot be changed.

When connecting the KX-TA Maintenance Console to the PBX using an RS-232C cable, assign the following values to the Serial Interface (RS-232C) port of the PBX:

Baud Rate (bps): 9600

Word Length: 8 bits

Parity Bit: None

Stop Bit: 1 bit

### To connect to the PBX by USB

1. From the **Connect** menu, select **Connect**.  
The **Connect to PBX** window will be displayed.
2. Select a connection option.
  - Select the **Use profile** check box if you want to use a pre-saved profile.
    - a. Select the profile to use from the drop-down list.
    - b. If the system password for the PBX has not been stored with the profile, enter it.  
If the system password has been stored with the selected profile, it does not need to be entered.
  - Select the **USB** radio button if you do not want to use a profile.
    - Enter the system password for the PBX.
3. Click **OK**.

## To connect to the PBX by Modem

1. From the **Connect** menu, select **Connect**.  
The **Connect to PBX** window will be displayed.
2. Select a connection option.
  - Select the **Use profile** check box if you want to use a pre-saved profile.
    - a. Select the profile to use from the drop-down list.  
The **Setup** button will become unavailable.
    - b. If the system password for the PBX has not been stored with the profile, enter it.  
If the system password has been stored with the selected profile, it does not need to be entered.
  - Select the **Modem** radio button if you want to enter parameters manually.
    - a. Enter the system password for the PBX.
    - b. Click **Setup**.

- c. Modify the connection parameters as required. For more details, see the table below.
  - d. Click **OK**.
3. Click **OK**.

The parameters are as follows:

Parameter	Values	Explanation
Dial Number	0-9, *, #, "-" (hyphen) and "," (comma)	Telephone number to be dialed to access the PBX.
Dial Type	Auto (Tone), Auto (Pulse), Manual	Outgoing dialing method. If "Manual" is selected, a telephone must be connected in parallel to dial.
Comment	–	Enter a comment to help to identify this profile.
Port	COMx	Specify the number of the COM port assigned to the PC's modem interface. Only available COM ports will be displayed.
Baud Rate (bps)	1200, 2400, 4800, 9600, 19200, 38400, 57600, 115200	Specify the speed of data transmission.
Flow Control	None, Hardware	Specify whether the rate of data transfer is managed by hardware or not.
Modem Initialize	Default, Custom	Specifies the command used to initialize the modem. If "Custom" is selected, enter the initialize string in the text box. Refer to your modem's instruction manual for more details.
Initialize	–	Click to send the specified initialize string to the modem.

## 6.2 Disconnect

Disconnects the PC from the PBX. Data transmission ends, and Maintenance Console returns to Initial mode.

### To disconnect

- From the **Connect** menu, select **Disconnect**.

If there is data that has been edited but not yet sent to the PBX, a confirmation window will be displayed.

- Click **Yes** to send the data to the PBX.
- Click **No** to discard the data.

## 6.3 Profile Setup

Profiles are useful when one PC is used to connect to multiple PBXs. Rather than manually adjusting the connection parameters each time a different PBX is accessed, it is possible to store the connection parameters for several PBXs. Then, when you wish to connect to a specific PBX, you can simply choose that PBX's profile from 6.1 Connect.

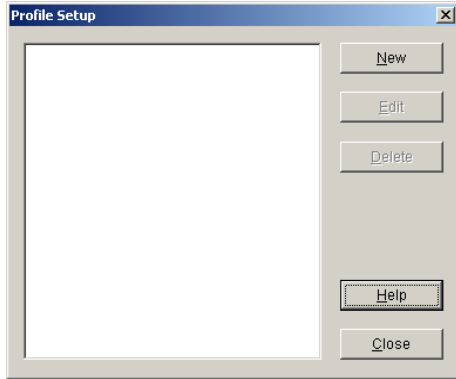

The functions of the buttons on this screen are as follows:

Button	Function
New	Opens the <b>Profile Editor</b> window to create a new profile. See 6.4 Profile Editor.
Edit	When an existing profile is selected, opens the <b>Profile Editor</b> window to modify the parameters of that profile. See 6.4 Profile Editor.
Delete	When an existing profile is selected, deletes that profile. A confirmation message will be displayed.
Close	Closes the current window.

## 6.4 Profile Editor

Allows the creation and editing of profiles of parameters required to connect the PC to the PBX by RS-232C, USB or modem.

### Notes

When a profile is edited and saved with a new name, the original profile is not deleted.

The parameters are as follows:

Parameter	Description
Profile Name	Enter a name used to identify this set of PBX connection parameters. This name must not be the same as another profile name.
System Password	Enter the password to log on to the target PBX, if required.
Default	Select the default connection method.

The functions of the buttons on this screen are as follows:

Button	Function
Save	Saves the current profile information.
Cancel	Closes the current screen without saving the profile information.

### To create or edit a profile

1. From the **Connect** menu, select **Profile Setup**.  
The **Profile Setup** window (6.3 Profile Setup) will be displayed.
2. Click **New** or **Edit**.  
The **Profile Editor** window will be displayed.
3. Enter a name for this profile.
4. Enter the system password used to connect to the PBX.
5. Select the default connection method.
6. Enter the detailed connection method parameters as required. See the tables below for more information.

It is possible to select connection methods other than the default method when connecting to the PBX using this profile. For this reason, you can choose to input parameters for both RS-232C and modem connection. Click the tabs to view the parameters for each type of connection.

7. Click **Save**.

### Connection parameters for RS-232C

The screenshot shows the Profile Editor window with the following fields and controls:

- Profile Name: [Text input field]
- System Password: [Text input field]
- Default:  RS-232C  USB  Modem
- RS-232C | Modem (tabbed interface)
- Port: [COM1] (dropdown menu)
- Baud Rate (bps): [9600] (text input)
- Word Length: [8 bits] (text input)
- Stop Bit: [1 bit] (text input)
- Parity Bit: [None] (text input)
- Buttons: Save, Cancel, Help

## 6.4 Profile Editor

The parameters are as follows:

Parameter	Values	Explanation
Port	COMx	Specify the number of the COM port assigned to the PC's RS-232C interface. Only available COM ports will be displayed.
Baud Rate (bps)	9600	Displays the speed of data transmission. This value cannot be changed.
Word Length	8 bits	Displays the number of bits in a word. This value cannot be changed.
Stop Bit	1 bit	Displays the length of the stop, used to identify the end of a transmitted group of bits. This value cannot be changed.
Parity Bit	None	Displays the kind of parity error-checking used. This value cannot be changed.

When connecting the KX-TA Maintenance Console to the PBX using an RS-232C cable, assign the following values to the Serial Interface (RS-232C) port of the PBX:

Baud Rate (bps): 9600

Word Length: 8 bits

Parity Bit: None

Stop Bit: 1 bit

### Connection parameters for Modem

The screenshot shows the 'Profile Editor' dialog box with the 'Modem' tab selected. The 'Default' radio button is selected, and the 'Modem Initialize' section is expanded. The 'Modem Initialize' section has the 'Default' radio button selected, and the text 'AT&FS10=150' is entered in the adjacent text box. Below the text box is an 'Initialize' button. At the bottom of the dialog are 'Save', 'Cancel', and 'Help' buttons.

Profile Name :

System Password :

Default :  RS-232C  USB  Modem

RS-232C Modem

Dial Number :

Dial Type : Auto (Tone)

Comment :

Port : COM1

Baud Rate (bps) : 115200

Flow Control : Hardware

Modem Initialize

Default

Custom

The parameters are as follows:

Parameter	Values	Explanation
Dial Number	0-9, *, #, "-" (hyphen) and "," (comma)	Telephone number to be dialed to access the PBX.
Dial Type	Auto (Tone), Auto (Pulse), Manual	Outgoing dialing method. If "Manual" is selected, a telephone must be connected in parallel to dial.
Comment	–	Enter a comment to help to identify this profile.
Port	COMx	Specify the number of the COM port assigned to the PC's modem interface. Only available COM ports will be displayed.
Baud Rate (bps)	1200, 2400, 4800, 9600, 19200, 38400, 57600, 115200	Specify the speed of data transmission.
Flow Control	None, Hardware	Specify whether the rate of data transfer is managed by hardware or not.
Modem Initialize	Default, Custom	Specifies the command used to initialize the modem. If "Custom" is selected, enter the initialize string in the text box. Refer to your modem's instruction manual for more details.
Initialize	–	Click to send the specified initialize string to the modem.



---

## **Section 7**

# ***PC Programming—View***

*This section describes the View menu, which allows you to customize the operation of Maintenance Console.*

## 7.1 Tool Bar

Selects whether the tool bar, which provides icons allowing easy access to commonly used functions, is displayed or not.

A check mark before this menu option means that the tool bar is set to be displayed.

### To change the display status of the tool bar

- From the **View** menu, select **Tool Bar**.

## 7.2 Programmer Code Change

Allows you to change the codes used to log on to Maintenance Console at startup.

Users logged on at Installer level may change both Installer level and User level codes. However, users logged on at User level can only change the User level code.

Programmer codes can contain any characters.

### To change the User level code

1. From the **View** menu, point to **Programmer Code Change**, and then click **User Level**.

The **Programmer Code Change** screen will be displayed.

2. Enter the desired new code.
3. Re-enter the same code for verification.  
If the entered codes do not match, an error message will be displayed.
  - Click **OK** to return to step 2 above.
4. Click **OK**.

### To change the Installer level code

1. From the **View** menu, point to **Programmer Code Change**, and then click **Installer Level**.

The **Programmer Code Change** screen will be displayed.

2. Enter the desired new code.

3. Re-enter the same code for verification.  
If the entered codes do not match, an error message will be displayed.
  - Click **OK** to return to step 2 above.
4. Click **OK**.

## 7.3 Screen Customize

Allows you to specify which system data setting screens and menu options can be accessed when logged in to Maintenance Console at User level.

This option is only available at Installer level.

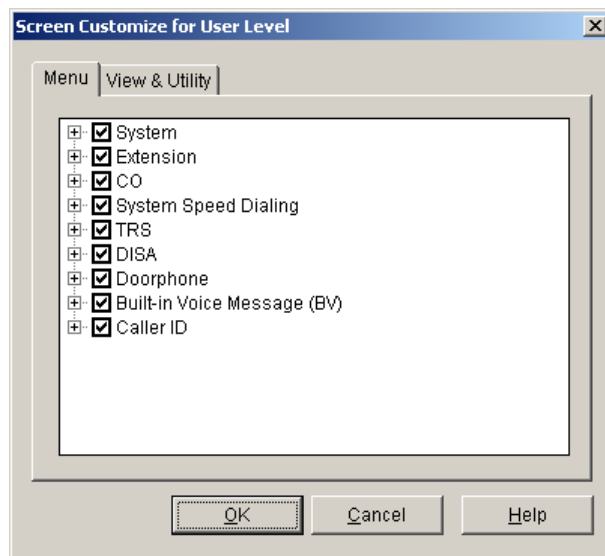

### To customize the displayed options

1. From the **View** menu, select **Screen Customize**.  
A list of the system data screens will be displayed in outline view.
  - Click the desired tab to view system data setting screens or menu options.
  - Click the plus sign to expand an item.
  - Click the minus sign to collapse a previously expanded item.
  - Clear the check boxes of screens you do not want to make available in User level.
2. Click **OK**.

## 7.4 System Data Setting Menu

Provides an alternative method of opening system data screens.

This option is only displayed in Batch and Interactive modes.

- From the **View** menu, point to **System Data Setting Menu**, point to the desired parent item, and then click the desired child item to open the relevant screen.



---

## **Section 8**

# ***PC Programming—Utility***

*This section describes the Utility menu, which contains options for performing system maintenance on the PBX.*

# 8.1 Firmware Upgrade

Allows installation of upgrades to the system software stored within the PBX. Only install upgrades provided by certified Panasonic dealers.

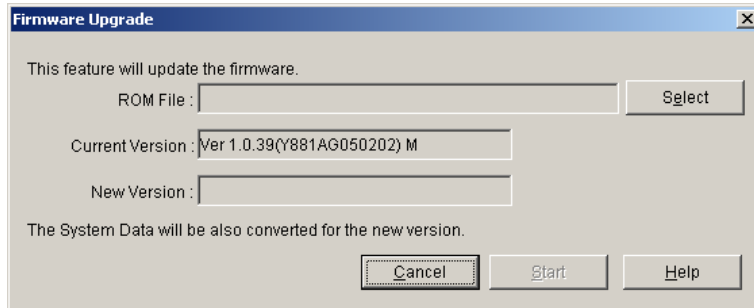

## To upgrade system software

1. From the **Utility** menu, select **Firmware Upgrade**.  
The **Firmware Upgrade** screen will be displayed.
2. Click **Select**.  
The **Open** dialog box will be displayed.
3. Navigate to the folder containing the system software file you want to install.
4. Select the file.
5. Click **Open**.
  - If the selected file is not a recognized ROM file, an error message will be displayed.
    - Click **OK** to return to step 2.
  - If the selected file is an older ROM version than the one currently installed to the PBX, a warning message will be displayed.
    - To accept the older ROM version, click **Yes**. Installing an older ROM is not recommended, as it may cause problems during system data conversion.
    - To not use the older ROM version, click **No**.
  - If the selected file is a ROM version newer than that of the current Maintenance Console software, a warning message will be displayed, as it cannot be supported by Maintenance Console.  
Information about the version of both the current system software and the selected file will be displayed.
6. Confirm that the selected file is the version that you intend to install to the PBX.
7. Click **Start**.  
A confirmation message will be displayed.
8. Click **Yes**.  
The system software will be upgraded in 3 steps. The progress bar shows how much of each process has been completed.  
When the upgrade is complete, a message will be displayed.
  - If there was a communication error during the upgrade, a message will be displayed.
    1. Check the listed items.
    2. Click **Retry** to try the upgrade process again.
  - If the PC freezes or loses power during one of the upgrade steps listed below, restart Maintenance Console, reconnect to the PBX, and follow the instructions below.

- While downloading system data from the PBX  
The **Firmware Upgrade** screen will be displayed automatically. Reselect the system software file and perform the upgrade again.
- While writing the new software to the PBX  
The PBX will be unable to start properly. The **Firmware Upgrade** screen will be displayed automatically. Reselect the system software file and perform the upgrade again.
- While restoring system data to the PBX  
The Firmware Upgrade process will be automatically restarted from this step, and system data will be restored to the PBX.

## 8.2 Quick Setup

Allows basic settings of the PBX to be modified easily.

This option can be accessed in either of 2 ways:

- Automatically when connecting to the PBX for the first time or after the PBX data has been cleared.
- Manually, by selecting **Quick Setup** from the **Utility** menu.

This option only runs automatically when the following conditions are met:

- The user is logged on to Maintenance Console using the Installer level programmer code.
- The date and time of the PBX have not yet been set.
- The model code of Maintenance Console and PBX match.
- The user has selected to connect Maintenance Console to the PBX in Interactive mode.

It can be run manually when the following condition is met:

- Maintenance Console is connected to the PBX in Interactive mode.

When the Quick Setup wizard is started manually, it is possible to cancel the wizard at any point by clicking the **Cancel** button. No changes will be made to the PBX. However, the **Cancel** button is not available when Quick Setup runs automatically upon connection to the PBX. In addition, when Quick Setup runs, it shows only default data for all programmable parameters. Any existing settings are not shown, and will be overwritten, so run Quick Setup manually only when necessary.

Using **Quick Setup**, the following basic parameters can be programmed as desired:

- The date and time. The PBX uses the date and time set to the PC. (→9.1.1 Date & Time [1-1])
- The system password. (→9.1.2 Main [1-2])
- The operator extension number. (→1.1.87 Operator/Manager Features in the Feature Manual)
- Automatic Configuration for CO Line Type (DTMF/Pulse). (→1.1.5 Automatic Configuration for Outside (CO) Line Type in the Feature Manual)
- Extension numbers and names. (→1.1.69 Intercom Call in the Feature Manual)
- Ringing assignment for each outside line (either all extensions, or a specific extension). (→1.1.90 Outside (CO) Line Ringing Selection in the Feature Manual)

### To set up basic items for the PBX

1. From the **Utility** menu, click **Quick Setup**.

The **Automatic Configuration for CO Line Type** screen will be displayed.

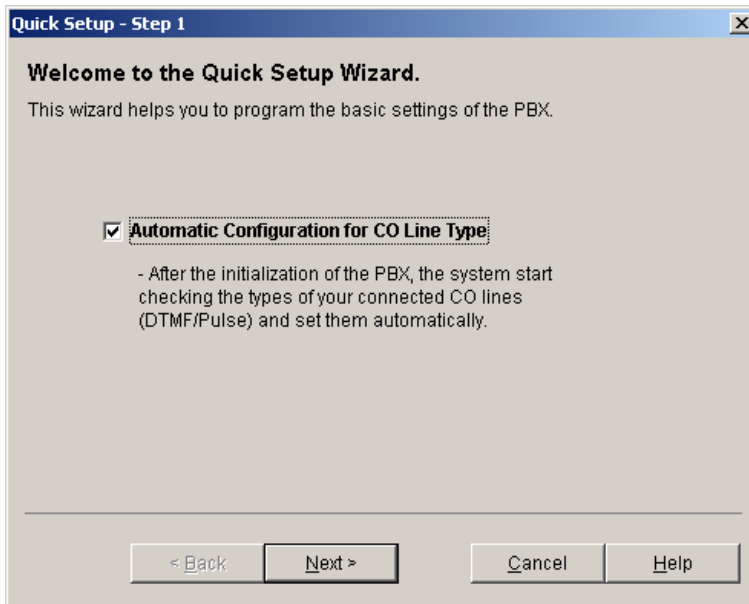

- If you do not want to automatically configure outside (CO) line types, deselect the check box.

2. Click **Next**

The Step 2 screen will be displayed.

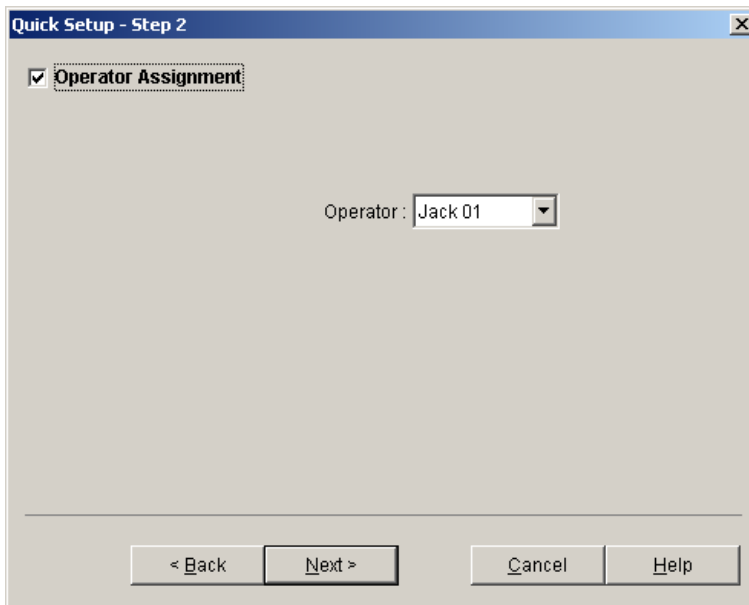

3. Select the jack number you wish to register as the operator extension, or "Disable".

- If you do not want to configure the operator extension, deselect the check box.

4. Click **Next**.

The Step 3 screen will be displayed.

Jack	Ext. no.	Name	Jack	Ext. no.	Name
01	101		13	113	
02	102		14	114	
03	103		15	115	
04	104		16	116	
05	105		17	117	
06	106		18	118	
07	107		19	119	
08	108		20	120	
09	109		21	121	
10	110		22	122	
11	111		23	123	
12	112		24	124	

## 5. Enter the desired extension number and name (if required) for each jack to configure in the table.

- If you do not want to configure extension numbers and names, deselect the check box.

6. Click **Next**.

The Step 4 screen will be displayed.

## 7. For each outside (CO) line, select the ringing assignment.

- Select "All extensions" to have all extensions ring for calls from that outside (CO) line.
- Select a jack number to have only that extension ring for calls from that outside (CO) line.
- If you do not want to configure a particular outside (CO) line, deselect the check box beside the name of that line.

### 8. Click **Next**.

The Step 5 screen will be displayed.

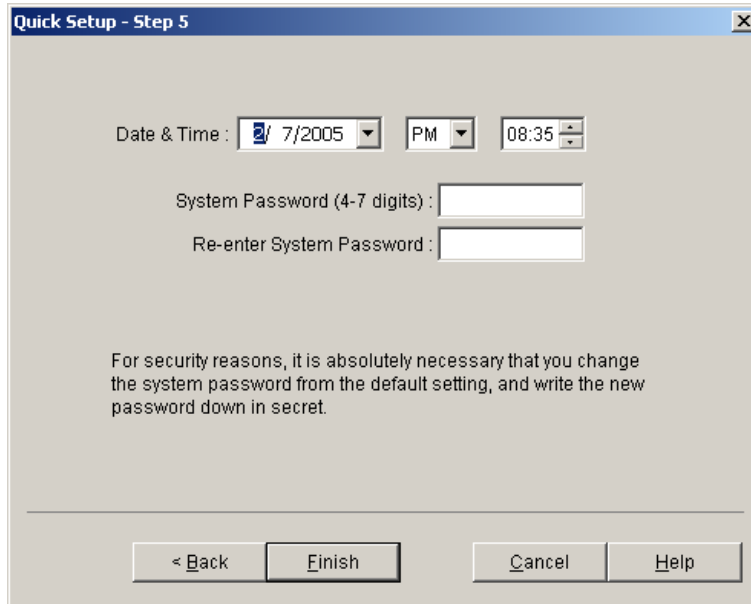

### 9. Enter the date and time.

- By default, the date and time of the PC are shown in these boxes.

### 10. Enter the desired system password, to be used to log on to the PBX.

- The password must be from 4 to 7 digits long.
- You must enter the same password 2 times, for confirmation.
- Be sure to make a note of the password entered here, as it will be required to log on to the PBX.

### 11. Click **Finish**.

- The data items set in steps 1 to 5 will be transmitted to the PBX. A completion message will be displayed.

### 12. Click **OK**.

## 8.3 System Reset

Resets the PBX.

There are 2 levels of reset:

- Normal: The PBX will be reset.
- Default: The PBX will be reset, and programming settings returned to their default values.

### 8.3.1 Normal

Resets the PBX.

#### To reset the PBX

1. From the **Utility** menu, point to **System Reset**, and then select **Normal**. A confirmation message will be displayed.

2. Click **Yes**.

The PBX will be disconnected from Maintenance Console, and will reset.

## 8.3.2 Default

Resets the PBX, and returns programming settings to their default values.

This option clears all settings within the PBX. Use this feature only when necessary, as all setting data within the PBX will be lost. If required, take a backup of system data in advance, using 5.7 File Transfer PBX to PC.

### To clear all settings and reset the PBX

1. From the **Utility** menu, point to **System Reset**, and then select **Default**.  
A confirmation message will be displayed.
2. Click **Yes**.  
The PBX will be disconnected from Maintenance Console, and will reset.

## 8.4 System Data Clear

Initializes PBX system data and programming settings. Use this feature only when necessary, as all system and setting data within the PBX will be lost. If required, take a backup of system data in advance, using 5.7 File Transfer PBX to PC.

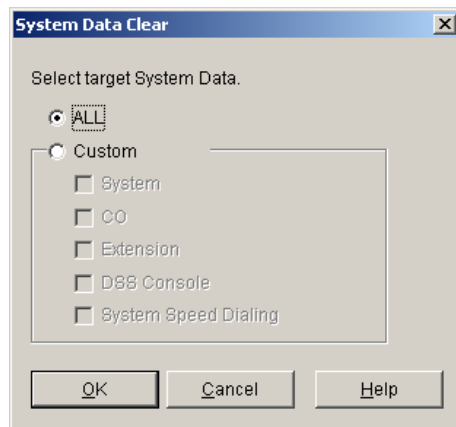

### To initialize PBX system data

1. From the **Utility** menu, select **System Data Clear**.  
The **System Data Clear** window will be displayed.
2. Select the system data to delete.
  - Click **ALL** to delete all system data.
  - Click **Custom** to select specific data to delete.
    - Select the appropriate check boxes.
3. Click **OK**.  
A completion message will be displayed.
4. Click **OK**.

## 8.5 DISA OGM Clear

Initializes the outgoing messages (OGMs) for the DISA feature.

DISA OGMs on both the preinstalled OGM card and the optional OGM card (if present) will be deleted.

### To clear all DISA OGMs

1. From the **Utility** menu, select **DISA OGM Clear**.  
A confirmation message will be displayed.
2. Click **Yes**.  
A completion message will be displayed.
3. Click **OK**.

## 8.6 BV Card Initialization

Initializes the optional BV card installed in the PBX, clearing all messages stored using the BV feature. This option requires that a BV card be installed in the PBX.

### To initialize the BV card

1. From the **Utility** menu, select **BV Card Initialization**.  
A confirmation message will be displayed.
2. Click **Yes**.  
A completion message will be displayed.
3. Click **OK**.

---

## **Section 9**

# ***PC Programming—System Data Setting***

*This section describes the options available on each setting screen of the Maintenance Console.*

## 9.1 System [1]

### 9.1.1 Date & Time [1-1]

The date and time of the PBX can be programmed. The date and time will be shown on the displays of proprietary telephones (PTs) and Station Message Detail Recording (SMDR).

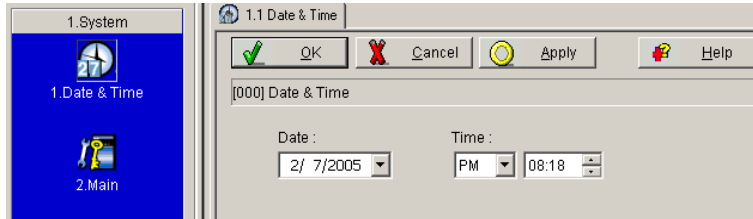

#### Date

Indicates the current date of the PBX. A calendar program window appears when you type or select the part of the date you want to change in the **Date** box. The day of the week is changed automatically to reflect the assigned date.

#### Default

05.Jan.1 Sat

#### Value Range

Year: 2000–2099

Month: 01–12

Day: 01–31

Week: Monday, Tuesday, Wednesday, Thursday, Friday, Saturday, Sunday

#### Programming Manual References

[000] Date & Time

#### Feature Manual References

1.1.112 Station Message Detail Recording (SMDR)

#### Time

Indicates the current time of the PBX. Type or select the part of the time you want to change in the **Time** box if necessary.

#### Default

AM12:00

#### Value Range

AM12:00–PM11:59

## Programming Manual References

[000] Date & Time

## Feature Manual References

1.1.112 Station Message Detail Recording (SMDR)

## 9.1.2 Main [1-2]

Various system settings can be programmed.

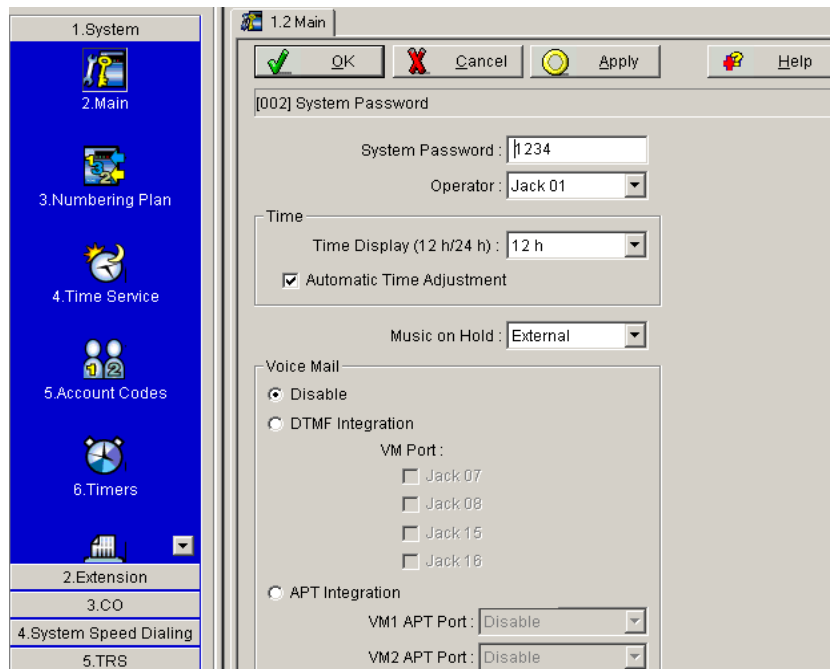

## System Password

Specifies the system password used to access system programming in interactive mode.

### Default

1234

### Value Range

4–7 digits (consisting of 0–9)

## Programming Manual References

[002] System Password

## Feature Manual References

1.1.99 PC Programming

1.1.103 PT Programming

## Operator

Selects the extension jack number to be designated as the operator.

### Default

Jack 01

### Value Range

Disable, Jack 01–24

### Programming Manual References

[008] Operator Assignment

### Feature Manual References

1.1.87 Operator/Manager Features

## Time—Time Display

Selects the time format shown on the displays of proprietary telephones (PTs) while on-hook. The Date & Time, Time Service, Station Message Detail Recording (SMDR) and Timed Reminder features use 12-hour format even if 24-hour format is assigned in this program.

### Default

12 h

### Value Range

12 h, 24 h

### Programming Manual References

[010] LCD Time Display

## Time—Automatic Time Adjustment

Enables the PBX to adjust its clock every day according to the time information included with the first Caller ID call after 3:05 A.M.

### Default

On

### Value Range

On (checked), Off (unchecked)

### Programming Manual References

[152] Automatic Time Adjustment

### Feature Manual References

1.1.6 Automatic Time Adjustment

## Music on Hold

Selects the audio source for Music on Hold and Background Music (BGM).

### Default

External

### Value Range

External, Tone

### Programming Manual References

[111] Music on Hold

### Feature Manual References

1.1.7 Background Music (BGM)

1.1.85 Music on Hold

## Voice Mail

Selects the method of Voice Mail Integration.

### Default

Disable

- DTMF Integration (VM Port): Off
- APT Integration (VM1 APT Port/VM2 APT Port): Disable

### Value Range

Disable, DTMF Integration, APT Integration

Disable: Disables both Inband (DTMF) and APT Integration.

DTMF Integration: Enables Inband (DTMF) Integration.

The following extension jack number(s) connected to a Panasonic VPS can be specified as the voice mail ports:

- VM Port: Jack 07, Jack 08, Jack 15, Jack 16

APT Integration: Enables APT Integration.

The following extension jack number(s) connected to a Panasonic VPS can be specified as the voice mail ports:

- VM1 APT Port: Disable, Jack 07, Jack 07 & 08
- VM2 APT Port: Disable, Jack 15, Jack 15 & 16

### Programming Manual References

[102] DTMF Integration Port

[103] DTMF Integration

[130] VM 1 APT Port

[131] VM 2 APT Port

### Feature Manual References

1.1.120 Voice Mail APT Integration

1.1.121 Voice Mail Inband (DTMF) Integration

## 9.1.3 Numbering Plan [1-3]

Extension numbers and extension names can be programmed for each extension.

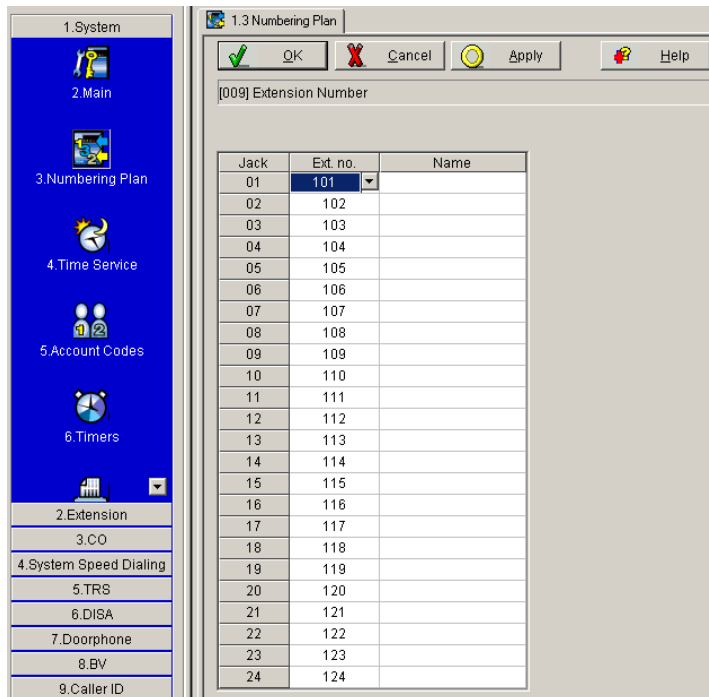

### Jack

Indicates the jack number (reference only). Sort in either ascending or descending order by clicking the **Jack** header.

### Value Range

01–24

### Ext. no.

Selects an extension number for each extension. Each extension must have a unique extension number. Sort in either ascending or descending order by clicking the **Ext. no.** header.

### Default

Jack 01–24 = Ext. no. 101–124 (e.g., Jack 01: Ext. no. 101, Jack 02: Ext. no. 102)

### Value Range

100–199

### Programming Manual References

[009] Extension Number

### Feature Manual References

1.1.57 Feature Numbering

## 1.1.69 Intercom Call

**Name**

Specifies the names of extensions, to be shown on the display of proprietary telephones (PTs) during intercom calls. Sort in either ascending or descending order by clicking the **Name** header.

**Default**

All jacks: — (Not stored)

**Value Range**

Max. 10 characters

**Programming Manual References**

[604] Extension Name

**Feature Manual References**

1.1.69 Intercom Call

## 9.1.4 Time Service [1-4]

A specific time service mode (day, night, or lunch) can be selected for operation depending on the time of the day. The time service mode can be switched either automatically or manually. When **Manual** is selected in the **Time Service Switching Mode** list, the current time service mode can be selected from the **Current Mode** list. Manual switching is possible only from an extension assigned as the operator or manager extension. When **Automatic** is selected, the current time service mode will switch to another time service mode at the time preprogrammed on the **9.1.5 Time Service [1-4] Time Setting** screen. In addition, the time service modes are distinguished in the table with different colors. To change the time in the Time Table, click **Time Setting**. To change the color settings of each time service mode, click **Day**, **Night**, or **Lunch**.

Week	AM											PM												
	12	1	2	3	4	5	6	7	8	9	10	11	12	1	2	3	4	5	6	7	8	9	10	11
Sunday																								
Monday																								
Tuesday																								
Wednesday																								
Thursday																								
Friday																								
Saturday																								

**Time Service Switching Mode**

Selects whether the time service mode is switched between day, lunch, and night manually or automatically.

**Default**

Manual

**Value Range**

Manual, Automatic

**Programming Manual References**

[006] Time Service Switching Mode  
 9.1.5 Time Service [1-4] Time Setting

**Feature Manual References**

1.1.114 Time Service

**Current Mode**

*This program is available only when **Manual** is selected in **Time Service Switching Mode** on this screen.*  
 Selects the current time service mode manually.

**Default**

Day

**Value Range**

Day, Night, Lunch

**Feature Manual References**

1.1.87 Operator/Manager Features  
 1.1.114 Time Service

**Operating Manual References**

2.1.9 Time Service

**9.1.5 Time Service [1-4] Time Setting**

*These settings are only available when **Automatic** is selected in **Time Service Switching Mode** on the **9.1.4 Time Service [1-4]** screen.*

Time Tables (containing day, lunch, and night start times and lunch end time) can be programmed for each day of the week.

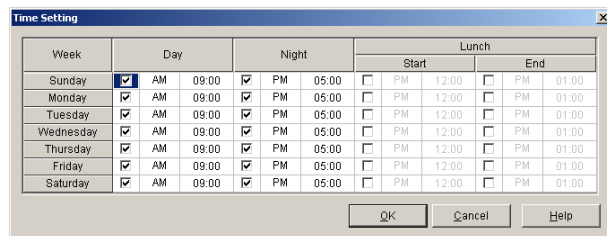

**Day**

Enables the setting of the Day start time. If enabled (checked), the start time can be specified.

**Default**

Every day of the week: On (AM09:00)

**Value Range**

On (AM12:00–PM11:59), Off

**Programming Manual References**

[007] Time Service Start Time

9.1.4 Time Service [1-4]—Time Service Switching Mode

**Feature Manual References**

1.1.114 Time Service

**Night**

Enables the setting of the Night start time. If enabled (checked), the start time can be specified.

**Default**

Every day of the week: On (PM05:00)

**Value Range**

On (AM12:00–PM11:59), Off

**Programming Manual References**

[007] Time Service Start Time

9.1.4 Time Service [1-4]—Time Service Switching Mode

**Feature Manual References**

1.1.114 Time Service

**Lunch—Start**

Enables the setting of the Lunch start time. If enabled (checked), the start time can be specified. Lunch mode overrides Day or Night mode.

**Default**

Every day of the week: Off

**Value Range**

On (AM12:00–PM11:59), Off

**Programming Manual References**

[007] Time Service Start Time

9.1.4 Time Service [1-4]—Time Service Switching Mode

**Feature Manual References**

1.1.114 Time Service

## Lunch—End

Enables the setting of the Lunch end time. If enabled (checked), the end time can be specified.

### Default

Every day of the week: Off

### Value Range

On (AM12:00–PM11:59), Off

### Programming Manual References

[007] Time Service Start Time

9.1.4 Time Service [1-4]—Time Service Switching Mode

### Feature Manual References

1.1.114 Time Service

## 9.1.6 Account Codes [1-5]

A maximum of 50 account codes can be programmed and used to identify outgoing outside (CO) line calls for accounting and billing purposes.

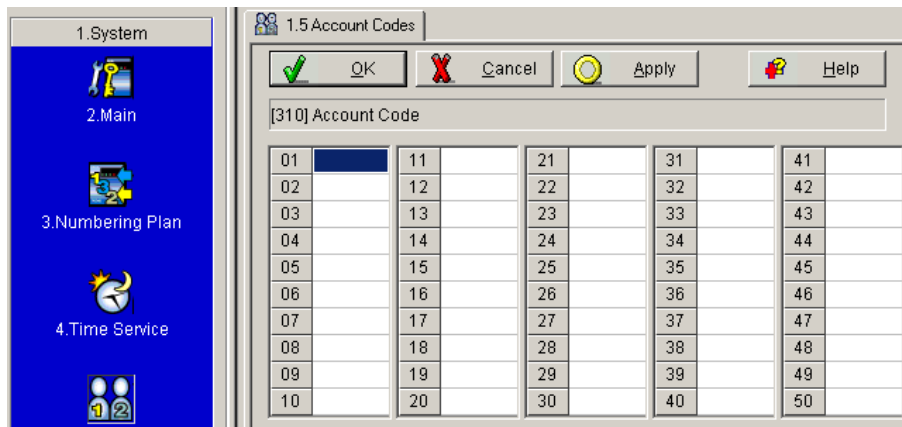

## Account Code

Specifies the account codes that must be entered when **Verify-All** (an account code is required to make an outside (CO) line call) or **Verify-Toll** (an account code is required to override Toll Restriction [TRS] temporarily) is selected in **Account Code Mode** on the **9.2.1 Main [2-1]** screen.

### Default

All codes: — (Not stored)

### Value Range

4 digits (consisting of 0–9)

### Programming Manual References

[310] Account Code

## 9.2.1 Main [2-1]—Account Code Mode

**Feature Manual References**

## 1.1.2 Account Code Entry

## 1.1.118 Toll Restriction (TRS) Override by Account Code

**9.1.7 Timers [1-6]**

Various system timers and counters can be programmed.

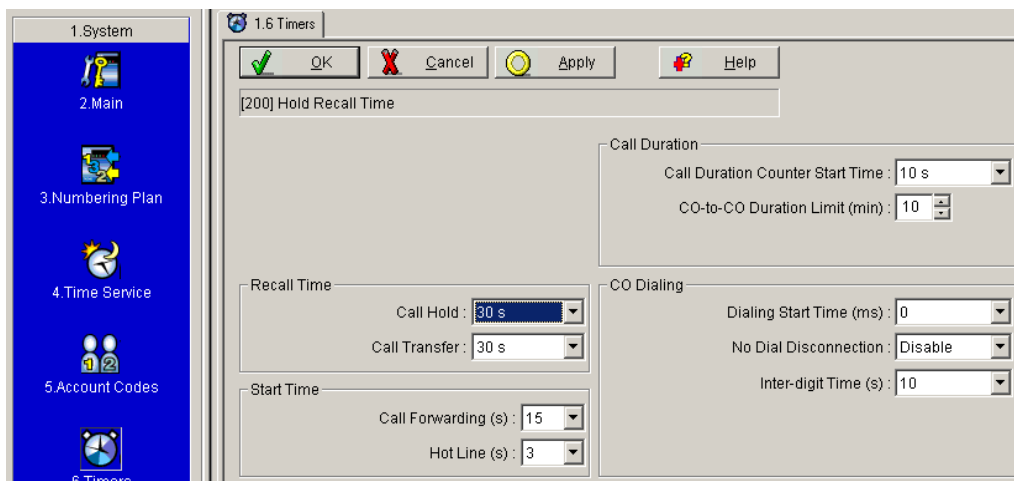
**Recall Time—Call Hold**

Selects the length of time a call on hold waits to be retrieved. If the call on hold is not retrieved within the time period programmed here, a ring tone will be heard at the extension that put the call on hold. If the extension is engaged in a call, an alarm tone will be heard.

**Default**

30 s

**Value Range**

Disable, 30 s, 1 min, 1.5 min, 2–6 min

**Programming Manual References**

[200] Hold Recall Time

**Feature Manual References**

## 1.1.15 Call Hold

## 1.1.16 Call Hold, Exclusive

## 1.1.19 Call Park

**Recall Time—Call Transfer**

Selects the length of time a transferred call waits to be answered. If the transfer destination does not answer the call within the time period programmed here, the call will return to the extension that transferred the call.

**Default**

30 s

**Value Range**

15 s, 30 s, 1 min, 2 min

**Programming Manual References**

[201] Transfer Recall Time

**Feature Manual References**

1.1.25 Call Transfer—To Extension

**Start Time—Call Forwarding**

Selects the length of time before a call is forwarded when the call is not answered.

**Default**

15 s

**Value Range**

5 s, 10 s, 15 s, 20 s

**Programming Manual References**

[202] Call Forwarding Start Time

**Feature Manual References**

1.1.12 Call Forwarding (FWD)—Busy/No Answer

**Start Time—Hot Line**

Selects the length of time until automatic dialing starts after a single line telephone (SLT) user goes off-hook.

**Default**

3 s

**Value Range**

0–4 s

**Programming Manual References**

[203] Hot Line Waiting Time

**Feature Manual References**

1.1.66 Hot Line

**Call Duration—Call Duration Counter Start Time**

Selects when the call timer starts, either immediately after an outside (CO) line is seized, or after the end of dialing. This corresponds to the length of the conversation displayed on the LCD and logged by SMDR.

**Default**

10 s

**Value Range**

Immediate, 5 x n (n=1–10) s

Immediate: The call timer starts immediately after an outside (CO) line is seized.

5 x n (n=1–10) s: The call timer starts after the end of dialing.

**Programming Manual References**

[204] Call Duration Counter Start

**Feature Manual References**

1.1.43 Display Information

1.1.112 Station Message Detail Recording (SMDR)

**Call Duration—CO-to-CO Duration Limit**

Selects the maximum length of time allowed for a conversation between 2 outside parties using the Call Forwarding (FWD) to Outside (CO) Line, Call Transfer to Outside (CO) Line, Unattended Conference, or DISA feature.

**Default**

10 min

**Value Range**

1–32 min

**Programming Manual References**

[205] CO-to-CO Line Call Duration

**Feature Manual References**

1.1.91 Outside-to-Outside (CO-to-CO) Line Call Duration

**CO Dialing—Dialing Start Time**

Selects the minimum length of time that the PBX waits after seizing an outside (CO) line before dialing.

**Default**

0 ms

**Value Range**

0 ms, 250 ms, 500 ms, 750 ms, 1000 ms, 1250 ms, 1500 ms

**Programming Manual References**

[206] Dialing Start Time

**Feature Manual References**

1.1.71 Line Access, Outside (CO) Line—SUMMARY

## CO Dialing—No Dial Disconnection

Selects whether or not to disconnect an outside (CO) line when an extension user does not dial anything within 10 seconds after seizing the outside (CO) line.

### Default

Disable

### Value Range

Disable (Do not disconnect), Enable (Disconnect)

### Programming Manual References

[211] No Dial Disconnection

### Feature Manual References

1.1.117 Toll Restriction (TRS)

## CO Dialing—Inter-digit Time

Selects the length of time allowed between digits for an outgoing outside (CO) line call.

### Default

10 s

### Value Range

5 s, 10 s, 15 s, 20 s

### Programming Manual References

[208] Inter-digit Time

### Feature Manual References

1.1.117 Toll Restriction (TRS)

## 9.1.8 SMDR [1-7]

Station Message Detail Recording (SMDR) automatically records detailed information about incoming and outgoing calls.

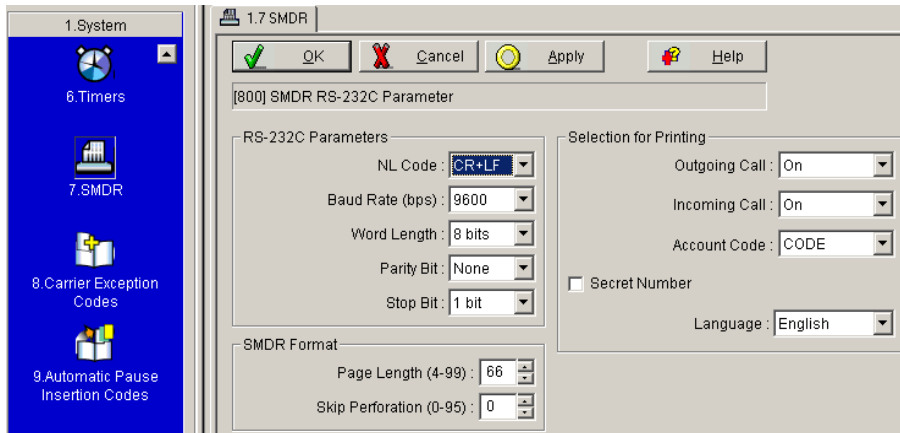

### RS-232C Parameters—NL Code

Selects the code appropriate for the PC or printer. If the PC or printer automatically feeds lines with carriage return, this selection must be set to **CR**. If not, **CR+LF**.

#### Default

CR+LF

#### Value Range

CR+LF, CR

CR: Carriage Return

LF: Line Feed

#### Programming Manual References

[800] SMDR RS-232C Parameter

#### Feature Manual References

1.1.112 Station Message Detail Recording (SMDR)

### RS-232C Parameters—Baud Rate

Selects the transmission speed of data from the PBX to the PC or printer.

#### Default

9600 bps

#### Value Range

1200 bps, 2400 bps, 4800 bps, 9600 bps

### Programming Manual References

[800] SMDR RS-232C Parameter

### Feature Manual References

1.1.112 Station Message Detail Recording (SMDR)

## RS-232C Parameters—Word Length

Selects how many bits compose each character.

### Default

8 bits

### Value Range

7 bits, 8 bits

### Programming Manual References

[800] SMDR RS-232C Parameter

### Feature Manual References

1.1.112 Station Message Detail Recording (SMDR)

## RS-232C Parameters—Parity Bit

Selects what type of parity is used to detect errors in the string of bits composing a character. When the error checking function is not required from the printer, **None** must be selected in this program.

### Default

None

### Value Range

None, Mark, Space, Even, Odd

### Programming Manual References

[800] SMDR RS-232C Parameter

### Feature Manual References

1.1.112 Station Message Detail Recording (SMDR)

## RS-232C Parameters—Stop Bit

Selects the end of a bit string that composes a character.

### **CAUTION**

Do not use the following combinations:

- **Parity Bit:** Mark, **Word Length:** 8 bits, **Stop Bit:** 2 bits
- **Parity Bit:** Space, **Word Length:** 8 bits, **Stop Bit:** 1 bit

- **Parity Bit:** Space, **Word Length:** 8 bits, **Stop Bit:** 2 bits

If any of the above invalid combinations are selected, an error message will be displayed.

### Default

1 bit

### Value Range

1 bit, 2 bits

### Programming Manual References

[800] SMDR RS-232C Parameter

### Feature Manual References

1.1.112 Station Message Detail Recording (SMDR)

## SMDR Format—Page Length

Selects the number of lines per page in order to match the paper size being used by the printer.

### Notes

To enable the changes, you must turn the power switch of the PBX off and back on again or reset the PBX (→8.3.1 Normal) after changing this setting.

### Default

66 lines

### Value Range

4–99 lines

### Programming Manual References

[801] SMDR Parameter

### Feature Manual References

1.1.112 Station Message Detail Recording (SMDR)

## SMDR Format—Skip Perforation

Selects the number of lines to be skipped at the end of every page in order to match the paper size being used by the printer.

### Notes

To enable the changes, you must turn the power switch of the PBX off and back on again or reset the PBX (→8.3.1 Normal) after changing this setting.

### Default

0 line

### Value Range

0–95 lines

### Programming Manual References

[801] SMDR Parameter

### Feature Manual References

1.1.112 Station Message Detail Recording (SMDR)

## Selection for Printing—Outgoing Call

Selects whether the dialed digits of outgoing outside (CO) line calls are printed.

### Default

On

### Value Range

On (Print all calls), Off (No printing), Toll (Print toll calls only)

### Programming Manual References

[802] Incoming/Outgoing Call Selection for Printing

### Feature Manual References

1.1.112 Station Message Detail Recording (SMDR)

## Selection for Printing—Incoming Call

Selects whether the dialed digits of incoming outside (CO) line calls are printed.

### Default

On

### Value Range

On (Print all calls), Off (No printing)

### Programming Manual References

[802] Incoming/Outgoing Call Selection for Printing

### Feature Manual References

1.1.112 Station Message Detail Recording (SMDR)

## Selection for Printing—Account Code

Selects whether to print out the account code stored in **Account Code** on the **9.1.6 Account Codes [1-5]** screen, or just the index of the account code on SMDR. *The index of the account code is shown when **Verify-All** or **Verify-Toll** is selected in **Account Code Mode** on the **9.2.1 Main [2-1]** screen.*

### Default

CODE

**Value Range**

CODE, INDEX

**Programming Manual References**

[805] SMDR Account Code

9.1.6 Account Codes [1-5]—Account Code

9.2.1 Main [2-1]—Account Code Mode

**Feature Manual References**

1.1.2 Account Code Entry

1.1.112 Station Message Detail Recording (SMDR)

1.1.118 Toll Restriction (TRS) Override by Account Code

**Selection for Printing—Secret Number**

Selects whether secret dialing numbers stored in **Line Access Number + Telephone Number** on the **9.4.1 System Speed Dialing [4-1]** screen or stored in One-touch Dialing buttons are printed with SMDR. Secret dialing numbers are not shown on the displays of proprietary telephones (PTs), regardless of this setting.

**Default**

Off

**Value Range**

On (checked), Off (unchecked)

**Programming Manual References**

[803] Secret Number SMDR Print Suppression

9.4.1 System Speed Dialing [4-1]—Line Access Number + Telephone Number

**Feature Manual References**

1.1.111 Secret Dialing

1.1.112 Station Message Detail Recording (SMDR)

**Selection for Printing—Language**

Selects the display language used for SMDR.

**Default**

English

**Value Range**

English, Spanish

**Programming Manual References**

[806] SMDR Language

## Feature Manual References

1.1.112 Station Message Detail Recording (SMDR)

## 9.1.9 Carrier Exception Codes [1-8]

A maximum of 20 Carrier Exception codes can be programmed. The PBX can recognize a user-dialed carrier code in order to apply Toll Restriction (TRS). The PBX disregards the assigned code and TRS is applied to the numbers after the code.

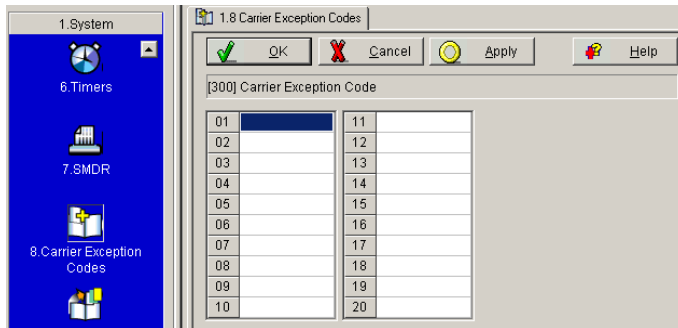

### Carrier Exception Code

Specifies the Carrier Exception codes.

#### Default

All codes: — (Not stored)

#### Value Range

Max. 10 digits (consisting of 0–9, \*, #, and x [wild card])

### Programming Manual References

[300] Carrier Exception Code

### Feature Manual References

1.1.117 Toll Restriction (TRS)



## 9.1.11 Detail [1-10]

Detailed information about the PBX can be programmed.

### Extension—Ring Tone Pattern

Selects the extension ring tone pattern for incoming intercom calls.

#### Default

Double

#### Value Range

Single, Double, Triple

### Programming Manual References

[115] Extension Ring Tone Pattern

### Feature Manual References

1.1.69 Intercom Call

1.1.108 Ring Tone Pattern Selection

2.2.1 Tones/Ring Tones

### Extension—Ringback Tone Pattern

Selects the ringback tone pattern for outgoing intercom calls and for incoming outside (CO) line calls (including a Direct Inward System Access [DISA] call).

#### Default

Single (5 s)

**Value Range**

Single (3 s), Single (5 s), Double (3 s), Double (5 s)

**Programming Manual References**

[128] Ringback Tone Pattern

**Feature Manual References**

1.1.41 Direct Inward System Access (DISA)

1.1.69 Intercom Call

2.2.1 Tones/Ring Tones

**Extension—External Pager Access Tone**

Enables the PBX to send a confirmation tone to the external pager before a paging announcement.

**Default**

On

**Value Range**

On (checked), Off (unchecked)

**Programming Manual References**

[106] External Pager Access Tone

**Feature Manual References**

1.1.94 Paging—All Extensions & External

1.1.95 Paging—External

**Extension—Call Pickup Tone**

Enables the PBX to send a confirmation tone when the Call Pickup feature is activated.

**Default**

On

**Value Range**

On (checked), Off (unchecked)

**Programming Manual References**

[117] Call Pickup Tone

**Feature Manual References**

1.1.20 Call Pickup, Directed

1.1.21 Call Pickup, Group

## Extension—Flash/Recall Mode for a Locked Extension

Enables a locked extension to send a flash/recall signal during a conversation with an outside party.

### Default

Off

### Value Range

On (checked), Off (unchecked)

### Programming Manual References

[108] Flash/Recall Mode for a Locked Extension

### Feature Manual References

1.1.55 Extension Lock

1.1.107 Remote Extension Lock

## Proprietary Telephone—Flash/Recall Key Mode

Selects the function of the FLASH/RECALL button on a proprietary telephone (PT) during a conversation with an outside party.

### Default

Mode 2

### Value Range

Mode 1 (EFA mode), Mode 2 (Flash/Recall mode)

### Programming Manual References

[110] Flash/Recall Key Mode

### Feature Manual References

1.1.56 External Feature Access (EFA)

1.1.60 Flash/Recall

## Proprietary Telephone—CO Indicator

*This program is available only for the extensions set to not ring in **Ringling for incoming CO calls—Day, Night, Lunch** on the **9.3.2 Incoming / Outgoing [3-2]** screen.*

Enables the corresponding PTs to answer incoming outside (CO) line calls. The CO button indicator will flash when an outside (CO) line call is received. If this program is enabled, a PT user can answer the call by pressing the flashing CO button. If this program is disabled, the user cannot answer the call even if he or she presses the CO button.

### Default

On

### Value Range

On (checked), Off (unchecked)

## Programming Manual References

[109] CO Indicator

9.3.2 Incoming / Outgoing [3-2]—Ringing for incoming CO calls—Day, Night, Lunch

## Proprietary Telephone—KX-T7700 Series Incoming Lamp Control

Enables the Message/Ringer Lamp on the KX-T7700 series telephones for the following incoming calls:

- Incoming call from an outside (CO) line with Caller ID information
- Incoming call from another extension to a busy extension when the called extension has set Call Waiting (Call Waiting Tone 1)
- Incoming call from a doorphone when an optional doorphone or doorbell/door chime is connected to the PBX

### Default

Off

### Value Range

On (checked), Off (unchecked)

## Programming Manual References

[968] KX-T7700 Series Incoming Lamp Control

## Feature Manual References

1.1.82 Message Waiting

1.1.83 Message Waiting for Another Extension

## Single Line Telephone—Hold Mode

Selects how calls are held and transferred with a single line telephone (SLT) when the Recall/hookswitch is pressed for less than 1000 ms.

### Default

Hold-1

### Value Range

Hold-1, Hold-2, Hold-3

## Programming Manual References

[104] SLT Hold Mode

## Feature Manual References

1.1.15 Call Hold

## Conference—Conference Tone

Enables the PBX to send a confirmation tone before starting or ending a conference call established by the Conference feature or Executive Busy Override feature.

**Default**

On

**Value Range**

On (checked), Off (unchecked)

**Programming Manual References**

[105] Conference Tone

**Feature Manual References**

1.1.33 Conference

1.1.50 Executive Busy Override—Extension

1.1.51 Executive Busy Override—Outside (CO) Line

**DSS—One-touch Transfer Using a DSS Button**

Selects how an outside (CO) line call is transferred to an extension using a Direct Station Selection (DSS) button.

**Default**

With Transfer

**Value Range**

With Transfer, Without Transfer

With Transfer: Press the DSS button to transfer the outside (CO) line call.

Without Transfer: Press the TRANSFER button, then the DSS button to transfer the outside (CO) line call.

**Programming Manual References**

[005] One-touch Transfer Using a DSS Button

**Feature Manual References**

1.1.25 Call Transfer—To Extension

1.1.59 Fixed Buttons

**DSS—DSS Lamp Mode**

Enables the Busy Lamp Field (BLF) on the DSS button to indicate the status, Call Forwarding (FWD) or Do Not Disturb (DND), of corresponding extensions.

**Default**

On

**Value Range**

On (checked), Off (unchecked)

On: FWD – Flashing slowly, DND – Flashing at moderate speed

Off: FWD – Off, DND – Off

### Programming Manual References

[112] DSS Lamp Mode

### Feature Manual References

1.1.70 LED Indication

## CO—Pulse dialing during a conversation

Enables the PBX to send pulse dialing to the telephone company during a conversation with an outside party when **Pulse** or **Call Blocking** is selected in **Dial Mode** on the **9.3.3 Detail [3-3]** screen.

### Default

On

### Value Range

On (checked), Off (unchecked)

### Programming Manual References

[118] Pulse Restriction

9.3.3 Detail [3-3]—Dial Mode

## CO—Redialing after Pulse to Tone Conversion

Enables the PBX to send DTMF (Dual Tone Multi-Frequency) dialing to the telephone company when an extension user redials after changing from pulse mode to DTMF mode by pressing "\*#".

### Default

Off

### Value Range

On (checked), Off (unchecked)

### Programming Manual References

[119] Redialing after Pulse to Tone Conversion

### Feature Manual References

1.1.104 Pulse to Tone Conversion

## DTMF Receiver Test—DTMF Receiver 1–6

Enables each DTMF receiver to check whether it is operating normally or not.

### Default

All DTMF receivers: On

### Value Range

On (checked), Off (unchecked)

DTMF receiver number:

## 9.2 Extension [2]

- 1–2: checking extension jacks 01–08
- 3–4: checking extension jacks 09–16
- 5–6: checking extension jacks 17–24

### Installation Manual References

4.1.3 Operation

### Programming Manual References

[107] DTMF Receiver Check

## 9.2 Extension [2]

### 9.2.1 Main [2-1]

Various parameters can be programmed for each extension. This screen is divided into 3 pages, each containing different settings. To show all parameters for a certain jack or extension, double-click the relevant **Jack** or **Extension Number** cell.

#### Page 1

Jack	Extension	Account Code Mode	Transfer to CO	Call Forward to CO	Busy Override	DND Override	Paralleled Telephone
01	101	Option	<input type="checkbox"/>	<input type="checkbox"/>	<input type="checkbox"/>	<input type="checkbox"/>	<input type="checkbox"/>
02	102	Option	<input type="checkbox"/>	<input type="checkbox"/>	<input type="checkbox"/>	<input type="checkbox"/>	<input type="checkbox"/>
03	103	Option	<input type="checkbox"/>	<input type="checkbox"/>	<input type="checkbox"/>	<input type="checkbox"/>	<input type="checkbox"/>
04	104	Option	<input type="checkbox"/>	<input type="checkbox"/>	<input type="checkbox"/>	<input type="checkbox"/>	<input type="checkbox"/>
05	105	Option	<input type="checkbox"/>	<input type="checkbox"/>	<input type="checkbox"/>	<input type="checkbox"/>	<input type="checkbox"/>
06	106	Option	<input type="checkbox"/>	<input type="checkbox"/>	<input type="checkbox"/>	<input type="checkbox"/>	<input type="checkbox"/>
07	107	Option	<input type="checkbox"/>	<input type="checkbox"/>	<input type="checkbox"/>	<input type="checkbox"/>	<input type="checkbox"/>
08	108	Option	<input type="checkbox"/>	<input type="checkbox"/>	<input type="checkbox"/>	<input type="checkbox"/>	<input type="checkbox"/>
09	109	Option	<input type="checkbox"/>	<input type="checkbox"/>	<input type="checkbox"/>	<input type="checkbox"/>	<input type="checkbox"/>
10	110	Option	<input type="checkbox"/>	<input type="checkbox"/>	<input type="checkbox"/>	<input type="checkbox"/>	<input type="checkbox"/>
11	111	Option	<input type="checkbox"/>	<input type="checkbox"/>	<input type="checkbox"/>	<input type="checkbox"/>	<input type="checkbox"/>
12	112	Option	<input type="checkbox"/>	<input type="checkbox"/>	<input type="checkbox"/>	<input type="checkbox"/>	<input type="checkbox"/>
13	113	Option	<input type="checkbox"/>	<input type="checkbox"/>	<input type="checkbox"/>	<input type="checkbox"/>	<input type="checkbox"/>
14	114	Option	<input type="checkbox"/>	<input type="checkbox"/>	<input type="checkbox"/>	<input type="checkbox"/>	<input type="checkbox"/>
15	115	Option	<input type="checkbox"/>	<input type="checkbox"/>	<input type="checkbox"/>	<input type="checkbox"/>	<input type="checkbox"/>
16	116	Option	<input type="checkbox"/>	<input type="checkbox"/>	<input type="checkbox"/>	<input type="checkbox"/>	<input type="checkbox"/>
17	117	Option	<input type="checkbox"/>	<input type="checkbox"/>	<input type="checkbox"/>	<input type="checkbox"/>	<input type="checkbox"/>
18	118	Option	<input type="checkbox"/>	<input type="checkbox"/>	<input type="checkbox"/>	<input type="checkbox"/>	<input type="checkbox"/>
19	119	Option	<input type="checkbox"/>	<input type="checkbox"/>	<input type="checkbox"/>	<input type="checkbox"/>	<input type="checkbox"/>
20	120	Option	<input type="checkbox"/>	<input type="checkbox"/>	<input type="checkbox"/>	<input type="checkbox"/>	<input type="checkbox"/>
21	121	Option	<input type="checkbox"/>	<input type="checkbox"/>	<input type="checkbox"/>	<input type="checkbox"/>	<input type="checkbox"/>
22	122	Option	<input type="checkbox"/>	<input type="checkbox"/>	<input type="checkbox"/>	<input type="checkbox"/>	<input type="checkbox"/>
23	123	Option	<input type="checkbox"/>	<input type="checkbox"/>	<input type="checkbox"/>	<input type="checkbox"/>	<input type="checkbox"/>
24	124	Option	<input type="checkbox"/>	<input type="checkbox"/>	<input type="checkbox"/>	<input type="checkbox"/>	<input type="checkbox"/>

#### Jack

Indicates the jack number (reference only).

#### Value Range

01–24

## Extension

Indicates the extension number and name (reference only).

### Value Range

Extension no. and name specified in **Ext. no.** and **Name** on the **9.1.3 Numbering Plan [1-3]** screen

### Programming Manual References

9.1.3 Numbering Plan [1-3]—Ext. no., Name

## Account Code Mode

Selects the account code entry mode for each extension.

### Default

All jacks: Option

### Value Range

Option, Forced, Verify-All, Verify-Toll

### Programming Manual References

[605] Account Code Mode

### Feature Manual References

1.1.2 Account Code Entry

1.1.118 Toll Restriction (TRS) Override by Account Code

## Transfer to CO

Enables the user to transfer an incoming call to any outside (CO) line.

### Default

All jacks: Off

### Value Range

On (checked), Off (unchecked)

### Programming Manual References

[606] Call Transfer to CO Line

### Feature Manual References

1.1.26 Call Transfer—To Outside (CO) Line

1.1.34 Conference, Unattended

## Call Forward to CO

Enables the user to forward an incoming call to any outside (CO) line.

**Default**

All jacks: Off

**Value Range**

On (checked), Off (unchecked)

**Programming Manual References**

[607] Call Forwarding to CO Line

**Feature Manual References**

1.1.14 Call Forwarding (FWD)—To Outside (CO) Line

**Busy Override**

Enables the user to interrupt another extension's existing call to establish a 3-party conference call.

**Default**

All jacks: Off

**Value Range**

On (checked), Off (unchecked)

**Programming Manual References**

[608] Executive Busy Override

**Feature Manual References**

1.1.50 Executive Busy Override—Extension

1.1.51 Executive Busy Override—Outside (CO) Line

**DND Override**

Enables the user to make a call to another extension that is in Do Not Disturb (DND) mode, by entering the feature number.

**Default**

All jacks: Off

**Value Range**

On (checked), Off (unchecked)

**Programming Manual References**

[609] DND Override

**Feature Manual References**

1.1.45 Do Not Disturb (DND) Override

## Paralleled Telephone

Specifies whether a single line telephone (SLT) is connected in parallel with a proprietary telephone (PT).

### Default

All jacks: Off

### Value Range

On (checked), Off (unchecked)

### Programming Manual References

[610] Paralleled Telephone

### Feature Manual References

1.1.97 Paralleled Telephone

## Page 2

Jack	Extension	TAM Connection	Room Monitor	Display Language	Wireless PT Port
01	101	<input type="checkbox"/>	<input type="checkbox"/>	English	Not connected
02	102	<input type="checkbox"/>	<input type="checkbox"/>	English	Not connected
03	103	<input type="checkbox"/>	<input type="checkbox"/>	English	Not connected
04	104	<input type="checkbox"/>	<input type="checkbox"/>	English	Not connected
05	105	<input type="checkbox"/>	<input type="checkbox"/>	English	Not connected
06	106	<input type="checkbox"/>	<input type="checkbox"/>	English	Not connected
07	107	<input type="checkbox"/>	<input type="checkbox"/>	English	Not connected
08	108	<input type="checkbox"/>	<input type="checkbox"/>	English	Not connected
09	109	<input type="checkbox"/>	<input type="checkbox"/>	English	Not connected
10	110	<input type="checkbox"/>	<input type="checkbox"/>	English	Not connected
11	111	<input type="checkbox"/>	<input type="checkbox"/>	English	Not connected
12	112	<input type="checkbox"/>	<input type="checkbox"/>	English	Not connected
13	113	<input type="checkbox"/>	<input type="checkbox"/>	English	Not connected
14	114	<input type="checkbox"/>	<input type="checkbox"/>	English	Not connected
15	115	<input type="checkbox"/>	<input type="checkbox"/>	English	Not connected
16	116	<input type="checkbox"/>	<input type="checkbox"/>	English	Not connected
17	117	<input type="checkbox"/>	<input type="checkbox"/>	English	Not connected
18	118	<input type="checkbox"/>	<input type="checkbox"/>	English	Not connected
19	119	<input type="checkbox"/>	<input type="checkbox"/>	English	Not connected
20	120	<input type="checkbox"/>	<input type="checkbox"/>	English	Not connected
21	121	<input type="checkbox"/>	<input type="checkbox"/>	English	Not connected
22	122	<input type="checkbox"/>	<input type="checkbox"/>	English	Not connected
23	123	<input type="checkbox"/>	<input type="checkbox"/>	English	Not connected
24	124	<input type="checkbox"/>	<input type="checkbox"/>	English	Not connected

### Jack

Indicates the jack number (reference only).

### Value Range

01–24

### Extension

Indicates the extension number and name (reference only).

### **Value Range**

Extension no. and name specified in **Ext. no.** and **Name** on the **9.1.3 Numbering Plan [1-3]** screen

### **Programming Manual References**

9.1.3 Numbering Plan [1-3]—Ext. no., Name

## **TAM Connection**

Specifies whether an extension is connected to a Telephone Answering Machine (TAM) to activate the Call Retrieving from a TAM feature.

### **Default**

All jacks: Off

### **Value Range**

On (checked), Off (unchecked)

### **Programming Manual References**

[611] TAM Extension

### **Feature Manual References**

1.1.23 Call Retrieving from a TAM (Telephone Answering Machine)

## **Room Monitor**

Specifies whether an extension can be monitored using the Room Monitor feature.

### **Default**

All jacks: Off

### **Value Range**

On (checked), Off (unchecked)

### **Programming Manual References**

[612] Room Monitor

### **Feature Manual References**

1.1.110 Room Monitor

## **Display Language**

Selects the language shown on the display of a PT.

### **Default**

All jacks: English

### **Value Range**

English, Spanish

## Programming Manual References

[615] LCD Language

## Feature Manual References

1.1.43 Display Information

## Wireless PT Port

Identifies whether a Panasonic wireless phone (e.g., KX-TD7895 or KX-T7885) is connected to an extension jack or not. If **Not connected** is selected for the jack that is connected to the Panasonic wireless phone, the wireless phone may function incorrectly.

### Default

All jacks: Not connected

### Value Range

Connected, Not connected

## Programming Manual References

[617] Wireless PT Port Assignment

## Page 3

Jack	Extension	MW for Another Extension	SLT MW	LCS Recording Mode	FWD Selection	BGM Control for APT
01	101	<input checked="" type="checkbox"/>	<input type="checkbox"/>	Stop Recording	<input type="checkbox"/>	<input type="checkbox"/>
02	102	<input checked="" type="checkbox"/>	<input type="checkbox"/>	Stop Recording	<input type="checkbox"/>	<input type="checkbox"/>
03	103	<input checked="" type="checkbox"/>	<input type="checkbox"/>	Stop Recording	<input type="checkbox"/>	<input type="checkbox"/>
04	104	<input checked="" type="checkbox"/>	<input type="checkbox"/>	Stop Recording	<input type="checkbox"/>	<input type="checkbox"/>
05	105	<input checked="" type="checkbox"/>	<input type="checkbox"/>	Stop Recording	<input type="checkbox"/>	<input type="checkbox"/>
06	106	<input checked="" type="checkbox"/>	<input type="checkbox"/>	Stop Recording	<input type="checkbox"/>	<input type="checkbox"/>
07	107	<input checked="" type="checkbox"/>	<input type="checkbox"/>	Stop Recording	<input type="checkbox"/>	<input type="checkbox"/>
08	108	<input checked="" type="checkbox"/>	<input type="checkbox"/>	Stop Recording	<input type="checkbox"/>	<input type="checkbox"/>
09	109	<input checked="" type="checkbox"/>	<input type="checkbox"/>	Stop Recording	<input type="checkbox"/>	<input type="checkbox"/>
10	110	<input checked="" type="checkbox"/>	<input type="checkbox"/>	Stop Recording	<input type="checkbox"/>	<input type="checkbox"/>
11	111	<input checked="" type="checkbox"/>	<input type="checkbox"/>	Stop Recording	<input type="checkbox"/>	<input type="checkbox"/>
12	112	<input checked="" type="checkbox"/>	<input type="checkbox"/>	Stop Recording	<input type="checkbox"/>	<input type="checkbox"/>
13	113	<input checked="" type="checkbox"/>	<input type="checkbox"/>	Stop Recording	<input type="checkbox"/>	<input type="checkbox"/>
14	114	<input checked="" type="checkbox"/>	<input type="checkbox"/>	Stop Recording	<input type="checkbox"/>	<input type="checkbox"/>
15	115	<input checked="" type="checkbox"/>	<input type="checkbox"/>	Stop Recording	<input type="checkbox"/>	<input type="checkbox"/>
16	116	<input checked="" type="checkbox"/>	<input type="checkbox"/>	Stop Recording	<input type="checkbox"/>	<input type="checkbox"/>
17	117	<input checked="" type="checkbox"/>	<input type="checkbox"/>	Stop Recording	<input type="checkbox"/>	<input type="checkbox"/>
18	118	<input checked="" type="checkbox"/>	<input type="checkbox"/>	Stop Recording	<input type="checkbox"/>	<input type="checkbox"/>
19	119	<input checked="" type="checkbox"/>	<input type="checkbox"/>	Stop Recording	<input type="checkbox"/>	<input type="checkbox"/>
20	120	<input checked="" type="checkbox"/>	<input type="checkbox"/>	Stop Recording	<input type="checkbox"/>	<input type="checkbox"/>
21	121	<input checked="" type="checkbox"/>	<input type="checkbox"/>	Stop Recording	<input type="checkbox"/>	<input type="checkbox"/>
22	122	<input checked="" type="checkbox"/>	<input type="checkbox"/>	Stop Recording	<input type="checkbox"/>	<input type="checkbox"/>
23	123	<input checked="" type="checkbox"/>	<input type="checkbox"/>	Stop Recording	<input type="checkbox"/>	<input type="checkbox"/>
24	124	<input checked="" type="checkbox"/>	<input type="checkbox"/>	Stop Recording	<input type="checkbox"/>	<input type="checkbox"/>

### Jack

Indicates the jack number (reference only).

### **Value Range**

01–24

## **Extension**

Indicates the extension number and name (reference only).

### **Value Range**

Extension no. and name specified in **Ext. no.** and **Name** on the **9.1.3 Numbering Plan [1-3]** screen

### **Programming Manual References**

9.1.3 Numbering Plan [1-3]—Ext. no., Name

## **MW for Another Extension**

Specifies whether an extension can use the Message Waiting for Another Extension feature. If this program is disabled (unchecked), an extension user cannot use a button as a Message for another extension button.

### **Default**

All jacks: On

### **Value Range**

On (checked), Off (unchecked)

### **Programming Manual References**

[618] Message Waiting for Another Extension

### **Feature Manual References**

1.1.83 Message Waiting for Another Extension

## **SLT MW**

Enables the PBX to send dial tone 3 as a message waiting notification to an SLT.

### **Default**

All jacks: Off

### **Value Range**

On (checked), Off (unchecked)

### **Programming Manual References**

[619] SLT Message Waiting

### **Feature Manual References**

1.1.82 Message Waiting

## LCS Recording Mode

Selects whether a message will continue being recorded in an extension's mailbox or stop being recorded, when the extension user answer the call while monitoring.

### Default

All jacks: Stop Recording

### Value Range

Stop Recording, Keep Recording

### Programming Manual References

[620] LCS Recording Mode Set

### Feature Manual References

1.1.77 Live Call Screening (LCS) (Voice Mail APT Integration only)

1.1.120 Voice Mail APT Integration

## FWD Selection

Enables the PBX to forward the calls received on outside (CO) lines programmed as **Normal** in **Mode of incoming CO calls—Day, Night, Lunch** on the **9.3.1 Line Mode [3-1]** screen. If this program is disabled (unchecked), outside (CO) line calls cannot be forwarded even if the extension user has set the Call Forwarding (FWD) feature.

### Default

All jacks: Off

### Value Range

On (checked), Off (unchecked)

### Programming Manual References

[963] Call Forwarding Selection

9.3.1 Line Mode [3-1]—Mode of incoming CO calls—Day, Night, Lunch

### Feature Manual References

1.1.11 Call Forwarding (FWD)—All Calls

1.1.12 Call Forwarding (FWD)—Busy/No Answer

1.1.13 Call Forwarding (FWD)—Follow Me

## BGM Control for APT

Enables the user to turn background music (BGM) on and off by dialing "1" while the extension is on-hook and idle.

### Default

All jacks: Off

**Value Range**

On (checked), Off (unchecked)

**Programming Manual References**

[626] BGM Control for APT

**Feature Manual References**

1.1.7 Background Music (BGM)

**9.2.2 Feature settings [2-2]**

Features related to extension operations can be programmed for each extension. This screen is divided into 3 pages, each containing different settings. To show all parameters for a certain jack or extension, double-click the relevant **Jack** or **Extension Number** cell.

**Page 1**

Jack	Extension	FWD/DND		Call Pickup Deny	Call Waiting	
		type	destination		intercom calls	outside calls
01	101	Cancel	---	<input type="checkbox"/>	<input type="checkbox"/>	<input type="checkbox"/>
02	102	Cancel	---	<input type="checkbox"/>	<input type="checkbox"/>	<input type="checkbox"/>
03	103	Cancel	---	<input type="checkbox"/>	<input type="checkbox"/>	<input type="checkbox"/>
04	104	Cancel	---	<input type="checkbox"/>	<input type="checkbox"/>	<input type="checkbox"/>
05	105	Cancel	---	<input type="checkbox"/>	<input type="checkbox"/>	<input type="checkbox"/>
06	106	Cancel	---	<input type="checkbox"/>	<input type="checkbox"/>	<input type="checkbox"/>
07	107	Cancel	---	<input type="checkbox"/>	<input type="checkbox"/>	<input type="checkbox"/>
08	108	Cancel	---	<input type="checkbox"/>	<input type="checkbox"/>	<input type="checkbox"/>
09	109	Cancel	---	<input type="checkbox"/>	<input type="checkbox"/>	<input type="checkbox"/>
10	110	Cancel	---	<input type="checkbox"/>	<input type="checkbox"/>	<input type="checkbox"/>
11	111	Cancel	---	<input type="checkbox"/>	<input type="checkbox"/>	<input type="checkbox"/>
12	112	Cancel	---	<input type="checkbox"/>	<input type="checkbox"/>	<input type="checkbox"/>
13	113	Cancel	---	<input type="checkbox"/>	<input type="checkbox"/>	<input type="checkbox"/>
14	114	Cancel	---	<input type="checkbox"/>	<input type="checkbox"/>	<input type="checkbox"/>
15	115	Cancel	---	<input type="checkbox"/>	<input type="checkbox"/>	<input type="checkbox"/>
16	116	Cancel	---	<input type="checkbox"/>	<input type="checkbox"/>	<input type="checkbox"/>
17	117	Cancel	---	<input type="checkbox"/>	<input type="checkbox"/>	<input type="checkbox"/>
18	118	Cancel	---	<input type="checkbox"/>	<input type="checkbox"/>	<input type="checkbox"/>
19	119	Cancel	---	<input type="checkbox"/>	<input type="checkbox"/>	<input type="checkbox"/>
20	120	Cancel	---	<input type="checkbox"/>	<input type="checkbox"/>	<input type="checkbox"/>
21	121	Cancel	---	<input type="checkbox"/>	<input type="checkbox"/>	<input type="checkbox"/>
22	122	Cancel	---	<input type="checkbox"/>	<input type="checkbox"/>	<input type="checkbox"/>
23	123	Cancel	---	<input type="checkbox"/>	<input type="checkbox"/>	<input type="checkbox"/>
24	124	Cancel	---	<input type="checkbox"/>	<input type="checkbox"/>	<input type="checkbox"/>

**Jack**

Indicates the jack number (reference only).

**Value Range**

01–24

**Extension**

Indicates the extension number and name (reference only).

**Value Range**

Extension no. and name specified in **Ext. no.** and **Name** on the **9.1.3 Numbering Plan [1-3]** screen

**Programming Manual References**

9.1.3 Numbering Plan [1-3]—Ext. no., Name

**FWD/DND**

Specifies whether an extension forwards or refuses calls directed to that extension when the user cannot answer calls. The forwarding destination can be specified depending on the forwarding type selected here.

**Default**

All jacks: Cancel

**Value Range**

Cancel, FWD ALL (ext no., BV), FWD Busy N/A (ext no., BV), FWD to CO (Max. 32 digits: line access no. + telephone no. [consisting of 0–9 and \*]), DND

**Feature Manual References**

1.1.10 Call Forwarding (FWD)—SUMMARY

1.1.44 Do Not Disturb (DND)

**Operating Manual References**

1.3.9 Call Forwarding (FWD)—SUMMARY

1.3.35 Do Not Disturb (DND)

**Call Pickup Deny**

Enables the prevention of calls being picked up by other extensions.

**Default**

All jacks: Off

**Value Range**

On (checked), Off (unchecked)

**Feature Manual References**

1.1.22 Call Pickup Deny

**Operating Manual References**

1.3.23 Call Pickup Deny

**Call Waiting—intercom calls**

Specifies whether an extension can receive a call waiting tone for calls from other extensions or doorphones.

**Default**

All jacks: Off

**Value Range**

On (checked), Off (unchecked)

**Feature Manual References**

1.1.9 Busy Station Signaling (BSS)

1.1.27 Call Waiting

**Operating Manual References**

1.3.8 Busy Station Signaling (BSS)

1.3.28 Call Waiting

**Call Waiting—outside calls**

Specifies whether an extension can receive a call waiting tone for calls from outside (CO) lines.

**Default**

All jacks: Off

**Value Range**

On (checked), Off (unchecked)

**Feature Manual References**

1.1.27 Call Waiting

**Operating Manual References**

1.3.28 Call Waiting

## Page 2

Jack	Extension	Data Line Security	Remote Extension Lock	Busy Override Deny	Log-in / Log-out	MW for Another Ext. Lock		Paging Deny	Monitored PT set	LCS Password
						lock	code			
01	101	<input type="checkbox"/>	<input type="checkbox"/>	<input type="checkbox"/>	Log-in	<input type="checkbox"/>	---	<input type="checkbox"/>	<input type="checkbox"/>	
02	102	<input type="checkbox"/>	<input type="checkbox"/>	<input type="checkbox"/>	Log-in	<input type="checkbox"/>	---	<input type="checkbox"/>	<input type="checkbox"/>	
03	103	<input type="checkbox"/>	<input type="checkbox"/>	<input type="checkbox"/>	Log-in	<input type="checkbox"/>	---	<input type="checkbox"/>	<input type="checkbox"/>	
04	104	<input type="checkbox"/>	<input type="checkbox"/>	<input type="checkbox"/>	Log-in	<input type="checkbox"/>	---	<input type="checkbox"/>	<input type="checkbox"/>	
05	105	<input type="checkbox"/>	<input type="checkbox"/>	<input type="checkbox"/>	Log-in	<input type="checkbox"/>	---	<input type="checkbox"/>	<input type="checkbox"/>	
06	106	<input type="checkbox"/>	<input type="checkbox"/>	<input type="checkbox"/>	Log-in	<input type="checkbox"/>	---	<input type="checkbox"/>	<input type="checkbox"/>	
07	107	<input type="checkbox"/>	<input type="checkbox"/>	<input type="checkbox"/>	Log-in	<input type="checkbox"/>	---	<input type="checkbox"/>	<input type="checkbox"/>	
08	108	<input type="checkbox"/>	<input type="checkbox"/>	<input type="checkbox"/>	Log-in	<input type="checkbox"/>	---	<input type="checkbox"/>	<input type="checkbox"/>	
09	109	<input type="checkbox"/>	<input type="checkbox"/>	<input type="checkbox"/>	Log-in	<input type="checkbox"/>	---	<input type="checkbox"/>	<input type="checkbox"/>	
10	110	<input type="checkbox"/>	<input type="checkbox"/>	<input type="checkbox"/>	Log-in	<input type="checkbox"/>	---	<input type="checkbox"/>	<input type="checkbox"/>	
11	111	<input type="checkbox"/>	<input type="checkbox"/>	<input type="checkbox"/>	Log-in	<input type="checkbox"/>	---	<input type="checkbox"/>	<input type="checkbox"/>	
12	112	<input type="checkbox"/>	<input type="checkbox"/>	<input type="checkbox"/>	Log-in	<input type="checkbox"/>	---	<input type="checkbox"/>	<input type="checkbox"/>	
13	113	<input type="checkbox"/>	<input type="checkbox"/>	<input type="checkbox"/>	Log-in	<input type="checkbox"/>	---	<input type="checkbox"/>	<input type="checkbox"/>	
14	114	<input type="checkbox"/>	<input type="checkbox"/>	<input type="checkbox"/>	Log-in	<input type="checkbox"/>	---	<input type="checkbox"/>	<input type="checkbox"/>	
15	115	<input type="checkbox"/>	<input type="checkbox"/>	<input type="checkbox"/>	Log-in	<input type="checkbox"/>	---	<input type="checkbox"/>	<input type="checkbox"/>	
16	116	<input type="checkbox"/>	<input type="checkbox"/>	<input type="checkbox"/>	Log-in	<input type="checkbox"/>	---	<input type="checkbox"/>	<input type="checkbox"/>	
17	117	<input type="checkbox"/>	<input type="checkbox"/>	<input type="checkbox"/>	Log-in	<input type="checkbox"/>	---	<input type="checkbox"/>	<input type="checkbox"/>	
18	118	<input type="checkbox"/>	<input type="checkbox"/>	<input type="checkbox"/>	Log-in	<input type="checkbox"/>	---	<input type="checkbox"/>	<input type="checkbox"/>	
19	119	<input type="checkbox"/>	<input type="checkbox"/>	<input type="checkbox"/>	Log-in	<input type="checkbox"/>	---	<input type="checkbox"/>	<input type="checkbox"/>	
20	120	<input type="checkbox"/>	<input type="checkbox"/>	<input type="checkbox"/>	Log-in	<input type="checkbox"/>	---	<input type="checkbox"/>	<input type="checkbox"/>	
21	121	<input type="checkbox"/>	<input type="checkbox"/>	<input type="checkbox"/>	Log-in	<input type="checkbox"/>	---	<input type="checkbox"/>	<input type="checkbox"/>	
22	122	<input type="checkbox"/>	<input type="checkbox"/>	<input type="checkbox"/>	Log-in	<input type="checkbox"/>	---	<input type="checkbox"/>	<input type="checkbox"/>	
23	123	<input type="checkbox"/>	<input type="checkbox"/>	<input type="checkbox"/>	Log-in	<input type="checkbox"/>	---	<input type="checkbox"/>	<input type="checkbox"/>	
24	124	<input type="checkbox"/>	<input type="checkbox"/>	<input type="checkbox"/>	Log-in	<input type="checkbox"/>	---	<input type="checkbox"/>	<input type="checkbox"/>	

**Jack**

Indicates the jack number (reference only).

**Value Range**

01–24

**Extension**

Indicates the extension number and name (reference only).

**Value Range**

Extension no. and name specified in **Ext. no.** and **Name** on the **9.1.3 Numbering Plan [1-3]** screen

**Programming Manual References**

9.1.3 Numbering Plan [1-3]—Ext. no., Name

**Data Line Security**

Enables the prevention of signals from other extensions during data transmission.

**Default**

All jacks: Off

**Value Range**

On (checked), Off (unchecked)

### **Feature Manual References**

1.1.37 Data Line Security

### **Operating Manual References**

1.3.33 Data Line Security

## **Remote Extension Lock**

Specifies whether an extension can be remotely locked or unlocked by the manager.

### **Default**

All jacks: Off

### **Value Range**

On (checked), Off (unchecked)

### **Feature Manual References**

1.1.107 Remote Extension Lock

### **Operating Manual References**

2.1.6 Remote Extension Lock

## **Busy Override Deny**

Enables the authorization to prevent other extensions from interrupting calls.

### **Default**

All jacks: Off

### **Value Range**

On (checked), Off (unchecked)

### **Feature Manual References**

1.1.50 Executive Busy Override—Extension

1.1.51 Executive Busy Override—Outside (CO) Line

### **Operating Manual References**

1.3.42 Executive Busy Override Deny

## **Log-in / Log-out**

Selects whether to join (Log-in) or leave (Log-out) an idle extension hunting group or Direct Inward System Access (DISA) ring group.

### **Default**

All jacks: Log-in

**Value Range**

Log-in, Log-out

**Feature Manual References**

1.1.80 Log-in/Log-out

**Operating Manual References**

1.3.59 Log-in/Log-out

**MW for Another Ext. Lock**

Enables the authorization to lock message waiting indications to prevent others from viewing, calling back or clearing message waiting indications left at a user's extension. If this setting is enabled, the code to lock and unlock message waiting indications can be specified.

**Default**

All jacks: Off

**Value Range**

lock, code

lock: On (checked), Off (unchecked)

code: 4 digits (4000–9999)

**Feature Manual References**

1.1.83 Message Waiting for Another Extension

**Operating Manual References**

1.3.62 Message Waiting for Another Extension Lock

**Paging Deny**

Enables the prevention of being paged by other extensions.

**Default**

All jacks: Off

**Value Range**

On (checked), Off (unchecked)

**Feature Manual References**

1.1.92 Paging—SUMMARY

**Operating Manual References**

1.3.73 Paging Deny

## Monitored PT set

*This program is available only for the extensions enabled in **Room Monitor** on the **9.2.1 Main [2-1]** screen. To set the Room Monitor feature at the monitored extension, select the check box for the extension in this program, and then press the AUTO ANS button of the extension to be monitored.*

### Default

All jacks: Off

### Value Range

On (checked), Off (unchecked)

### Programming Manual References

9.2.1 Main [2-1]—Room Monitor

### Feature Manual References

1.1.110 Room Monitor

### Operating Manual References

1.3.80 Room Monitor

## LCS Password

Specifies the Live Call Screening (LCS) password to prevent the unauthorized screening of calls.

### Default

All jacks: — (Not stored)

### Value Range

3 digits (consisting of 0–9)

### Feature Manual References

1.1.77 Live Call Screening (LCS) (Voice Mail APT Integration only)

### Operating Manual References

1.3.56 Live Call Screening (LCS) (Voice Mail APT Integration only)

## Page 3

Jack	Extension	Hot Line for SLT		Timed Reminder		Voice Mail Integration
		set	phone no.	set	time	
01	101	<input type="checkbox"/>		Cancel	---	B: send #6+ext no.
02	102	<input type="checkbox"/>		Cancel	---	B: send #6+ext no.
03	103	<input type="checkbox"/>		Cancel	---	B: send #6+ext no.
04	104	<input type="checkbox"/>		Cancel	---	B: send #6+ext no.
05	105	<input type="checkbox"/>		Cancel	---	B: send #6+ext no.
06	106	<input type="checkbox"/>		Cancel	---	B: send #6+ext no.
07	107	<input type="checkbox"/>		Cancel	---	B: send #6+ext no.
08	108	<input type="checkbox"/>		Cancel	---	B: send #6+ext no.
09	109	<input type="checkbox"/>		Cancel	---	B: send #6+ext no.
10	110	<input type="checkbox"/>		Cancel	---	B: send #6+ext no.
11	111	<input type="checkbox"/>		Cancel	---	B: send #6+ext no.
12	112	<input type="checkbox"/>		Cancel	---	B: send #6+ext no.
13	113	<input type="checkbox"/>		Cancel	---	B: send #6+ext no.
14	114	<input type="checkbox"/>		Cancel	---	B: send #6+ext no.
15	115	<input type="checkbox"/>		Cancel	---	B: send #6+ext no.
16	116	<input type="checkbox"/>		Cancel	---	B: send #6+ext no.
17	117	<input type="checkbox"/>		Cancel	---	B: send #6+ext no.
18	118	<input type="checkbox"/>		Cancel	---	B: send #6+ext no.
19	119	<input type="checkbox"/>		Cancel	---	B: send #6+ext no.
20	120	<input type="checkbox"/>		Cancel	---	B: send #6+ext no.
21	121	<input type="checkbox"/>		Cancel	---	B: send #6+ext no.
22	122	<input type="checkbox"/>		Cancel	---	B: send #6+ext no.
23	123	<input type="checkbox"/>		Cancel	---	B: send #6+ext no.
24	124	<input type="checkbox"/>		Cancel	---	B: send #6+ext no.

**Jack**

Indicates the jack number (reference only).

**Value Range**

01–24

**Extension**

Indicates the extension number and name (reference only).

**Value Range**

Extension no. and name specified in **Ext. no.** and **Name** on the **9.1.3 Numbering Plan [1-3]** screen

**Programming Manual References**

9.1.3 Numbering Plan [1-3]—Ext. no., Name

**Hot Line for SLT**

Enables the Hot Line feature.

**Default**

All jacks: Off [set], — (Not stored) [phone no.]

**Value Range**

set, phone no.

set: On (checked), Off (unchecked)

phone no: Max. 32 digits (consisting of 0–9, \*, and P [pause])

### Feature Manual References

1.1.66 Hot Line

### Operating Manual References

1.3.50 Hot Line

## Timed Reminder

Enables the Timed Reminder feature. When **One Time** or **Daily** is selected, the setting time can be specified.

### Default

All jacks: Cancel

### Value Range

Cancel, One Time (AM12:00–PM11:59), Daily (AM12:00–PM11:59)

### Feature Manual References

1.1.115 Timed Reminder

1.1.116 Timed Reminder, Remote

### Operating Manual References

1.3.84 Timed Reminder

2.1.10 Timed Reminder, Remote (Wake-up Call)

## Voice Mail Integration

Selects the Follow-on ID format required by your Voice Processing System (VPS).

### Default

All jacks: B: send #6+ext no.

### Value Range

Cancel, A: send ext no., B: send #6+ext no.

### Feature Manual References

1.1.121 Voice Mail Inband (DTMF) Integration

### Operating Manual References

1.3.88 Voice Mail Integration

## 9.2.3 PT personal settings [2-3]

Various personal programming settings on a proprietary telephone (PT) can be programmed for each extension. This screen is divided into 2 pages, each containing different settings. To show all parameters for a certain jack or extension, double-click the relevant **Jack** or **Extension Number** cell.

## Page 1

2.3 PT personal settings

[PT Personal] Line Preference - Outgoing

Jack	Extension	Line Preference		CO Line Ringing Selection								
		Outgoing	Incoming	CO1	CO2	CO3	CO4	CO5	CO6	CO7	CO8	
01	101	No Line	Ring Line	✓	✓	✓	✓	✓	✓	✓	✓	✓
02	102	No Line	Ring Line	✓	✓	✓	✓	✓	✓	✓	✓	✓
03	103	No Line	Ring Line	✓	✓	✓	✓	✓	✓	✓	✓	✓
04	104	No Line	Ring Line	✓	✓	✓	✓	✓	✓	✓	✓	✓
05	105	No Line	Ring Line	✓	✓	✓	✓	✓	✓	✓	✓	✓
06	106	No Line	Ring Line	✓	✓	✓	✓	✓	✓	✓	✓	✓
07	107	No Line	Ring Line	✓	✓	✓	✓	✓	✓	✓	✓	✓
08	108	No Line	Ring Line	✓	✓	✓	✓	✓	✓	✓	✓	✓
09	109	No Line	Ring Line	✓	✓	✓	✓	✓	✓	✓	✓	✓
10	110	No Line	Ring Line	✓	✓	✓	✓	✓	✓	✓	✓	✓
11	111	No Line	Ring Line	✓	✓	✓	✓	✓	✓	✓	✓	✓
12	112	No Line	Ring Line	✓	✓	✓	✓	✓	✓	✓	✓	✓
13	113	No Line	Ring Line	✓	✓	✓	✓	✓	✓	✓	✓	✓
14	114	No Line	Ring Line	✓	✓	✓	✓	✓	✓	✓	✓	✓
15	115	No Line	Ring Line	✓	✓	✓	✓	✓	✓	✓	✓	✓
16	116	No Line	Ring Line	✓	✓	✓	✓	✓	✓	✓	✓	✓
17	117	No Line	Ring Line	✓	✓	✓	✓	✓	✓	✓	✓	✓
18	118	No Line	Ring Line	✓	✓	✓	✓	✓	✓	✓	✓	✓
19	119	No Line	Ring Line	✓	✓	✓	✓	✓	✓	✓	✓	✓
20	120	No Line	Ring Line	✓	✓	✓	✓	✓	✓	✓	✓	✓
21	121	No Line	Ring Line	✓	✓	✓	✓	✓	✓	✓	✓	✓
22	122	No Line	Ring Line	✓	✓	✓	✓	✓	✓	✓	✓	✓
23	123	No Line	Ring Line	✓	✓	✓	✓	✓	✓	✓	✓	✓
24	124	No Line	Ring Line	✓	✓	✓	✓	✓	✓	✓	✓	✓

**Jack**

Indicates the jack number (reference only).

**Value Range**

01–24

**Extension**

Indicates the extension number and name (reference only).

**Value Range**

Extension no. and name specified in **Ext. no.** and **Name** on the **9.1.3 Numbering Plan [1-3]** screen

**Programming Manual References**

9.1.3 Numbering Plan [1-3]—Ext. no., Name

**Line Preference—Outgoing**

Selects the line to be seized after going off-hook to make a call.

**Default**

All jacks: No Line

**Value Range**

No Line, Idle Line, CO 1–8

### **Feature Manual References**

1.1.76 Line Preference—Outgoing

### **Operating Manual References**

3.1.2 Personal Feature Assignment—Line Preference—Outgoing

## **Line Preference—Incoming**

Selects the line on which an incoming call is answered after going off-hook.

### **Default**

All jacks: Ringing Line

### **Value Range**

No Line, Ringing Line, CO 1–8

### **Feature Manual References**

1.1.75 Line Preference—Incoming

### **Operating Manual References**

3.1.2 Personal Feature Assignment—Line Preference—Incoming

## **CO Line Ringing Selection—CO1–8**

Specifies whether an extension will ring when receiving a call from an outside (CO) line.

### **Default**

All jacks: On

### **Value Range**

On (checked), Off (unchecked)

### **Feature Manual References**

1.1.90 Outside (CO) Line Ringing Selection

### **Operating Manual References**

3.1.2 Personal Feature Assignment—Outside (CO) Line Ringing Selection

## Page 2

Jack	Extension	Extension Password	Alternate Receiving	Call Waiting Tone Type	LCS Mode
01	101		Tone Call	Tone 1	Hands-free
02	102		Tone Call	Tone 1	Hands-free
03	103		Tone Call	Tone 1	Hands-free
04	104		Tone Call	Tone 1	Hands-free
05	105		Tone Call	Tone 1	Hands-free
06	106		Tone Call	Tone 1	Hands-free
07	107		Tone Call	Tone 1	Hands-free
08	108		Tone Call	Tone 1	Hands-free
09	109		Tone Call	Tone 1	Hands-free
10	110		Tone Call	Tone 1	Hands-free
11	111		Tone Call	Tone 1	Hands-free
12	112		Tone Call	Tone 1	Hands-free
13	113		Tone Call	Tone 1	Hands-free
14	114		Tone Call	Tone 1	Hands-free
15	115		Tone Call	Tone 1	Hands-free
16	116		Tone Call	Tone 1	Hands-free
17	117		Tone Call	Tone 1	Hands-free
18	118		Tone Call	Tone 1	Hands-free
19	119		Tone Call	Tone 1	Hands-free
20	120		Tone Call	Tone 1	Hands-free
21	121		Tone Call	Tone 1	Hands-free
22	122		Tone Call	Tone 1	Hands-free
23	123		Tone Call	Tone 1	Hands-free
24	124		Tone Call	Tone 1	Hands-free

**Jack**

Indicates the jack number (reference only).

**Value Range**

01–24

**Extension**

Indicates the extension number and name (reference only).

**Value Range**

Extension no. and name specified in **Ext. no.** and **Name** on the **9.1.3 Numbering Plan [1-3]** screen

**Programming Manual References**

9.1.3 Numbering Plan [1-3]—Ext. no., Name

**Extension Password**

Specifies the extension password used for the Walking COS feature and the Remote Extension Lock feature. The extension password should be unique to that extension.

**Default**

All jacks: — (Not stored)

**Value Range**

4 digits (consisting of 0–9)

**Feature Manual References**

1.1.87 Operator/Manager Features

**Operating Manual References**

2.1.7 System Feature Assignment—Extension Password Set (Manager only)

**Alternate Receiving**

Selects the method of receiving intercom calls.

**Default**

All jacks: Tone Call

**Value Range**

Tone Call, Voice Call

**Feature Manual References**

1.1.69 Intercom Call

**Operating Manual References**

3.1.2 Personal Feature Assignment—Alternate Receiving—Ring/Voice

**Call Waiting Tone Type**

Selects the type of Call Waiting tone to receive when an extension is busy and a new call arrives.

**Default**

All jacks: Tone 1

**Value Range**

Tone 1, Tone 2

**Feature Manual References**

1.1.27 Call Waiting

**Operating Manual References**

3.1.2 Personal Feature Assignment—Call Waiting Tone Type Selection

**LCS Mode**

Selects whether the extension's mailbox is monitored in Hands-free or Private mode.

**Default**

All jacks: Hands-free

## Value Range

Hands-free, Private

Hands-free: The extension user can screen calls automatically through the built-in speaker.

Private: The extension user will hear an alert tone when a message is being recorded in his or her mailbox. To screen calls, the extension user must press the MONITOR, SP-PHONE, or LCS button.

## Feature Manual References

1.1.77 Live Call Screening (LCS) (Voice Mail APT Integration only)

## Operating Manual References

3.1.2 Personal Feature Assignment—Live Call Screening (LCS) Mode Set

## 9.2.4 Flexible Buttons [2-4]

Each flexible CO, Programmable Feature (PF), or MESSAGE button can be customized to allow one-touch access to a certain feature. The button settings of an extension can be copied to other extensions. Select the extension whose buttons you want to copy from the **Extension jack** list, then click **Copy**.

Clicking a CO button opens the **9.2.5 Flexible Buttons [2-4] CO buttons** screen, which allows you to specify the feature to be assigned to a flexible CO button on the selected extension.

Clicking a PF button opens the **9.2.6 Flexible Buttons [2-4] PF buttons** screen, which allows you to specify the feature to be assigned to a PF button on the selected extension.

Clicking the Message button opens the **9.2.7 Flexible Buttons [2-4] Message button** screen, which allows you to specify the feature to be assigned to the MESSAGE button on the selected extension.

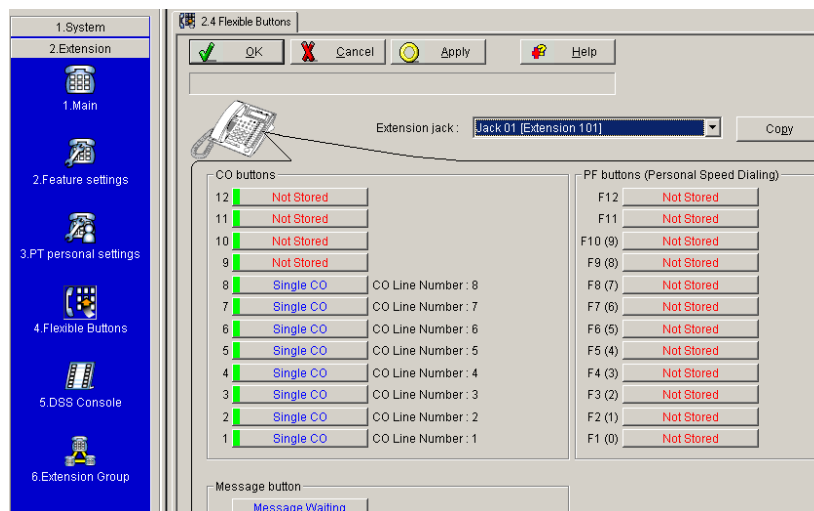

## Extension jack

Selects the jack number of the extension to edit. The extension number and name are shown with the jack number.

## Value Range

Jack 01–24 (Extension no. and name specified in **Ext. no.** and **Name** on the **9.1.3 Numbering Plan [1-3]** screen)

## Programming Manual References

9.1.3 Numbering Plan [1-3]—Ext. no., Name

## CO buttons

Each CO button can be customized to access a certain feature with a one-touch operation.

### Default

Button 1–8: Single CO (CO Line Number 1–8), Button 9–12: Not Stored

### Value Range

Not Stored, Single CO, Group CO, Direct Station Selection (DSS), One-touch Dialing, Other CO, Conference, FWD/DND, Saved Number Redial, Caller ID Indication—Personal, Caller ID Selection—Personal, Log-in/Log-out, 2-way Record, 2-way Transfer, Live Call Screening (LCS), LCS Cancel, Voice Mail Transfer, Another Extension Message Waiting, Caller ID Indication—Common, Caller ID Selection—Common

## Programming Manual References

9.2.5 Flexible Buttons [2-4] CO buttons

## Feature Manual References

1.1.61 Flexible Buttons

## Operating Manual References

3.1.3 Flexible Button Assignment

## PF buttons

Each PF button can be customized to access a certain feature with a one-touch operation.

### Default

All buttons: Not Stored

### Value Range

Not Stored, One-touch Dialing

## Programming Manual References

9.2.6 Flexible Buttons [2-4] PF buttons

## Feature Manual References

1.1.61 Flexible Buttons

## Operating Manual References

3.1.3 Flexible Button Assignment

## Message button

The Message button can be customized to access a certain feature with a one-touch operation.

**Default**

Message Waiting

**Value Range**

Not Stored, Direct Station Selection (DSS), One-touch Dialing, Message Waiting

**Programming Manual References**

9.2.7 Flexible Buttons [2-4] Message button

**Feature Manual References**

1.1.61 Flexible Buttons

**Operating Manual References**

3.1.3 Flexible Button Assignment

## 9.2.5 Flexible Buttons [2-4] CO buttons

Each CO button can be customized to access a certain feature with a one-touch operation. A maximum of 12 CO buttons can be customized for each extension. Select the desired extension from the **Extension jack** list on the **9.2.4 Flexible Buttons [2-4]** screen. Depending on the button type, additional parameters are required as follows:

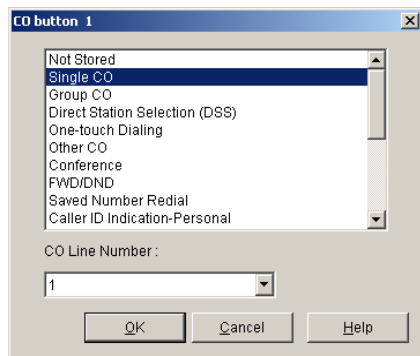

### CO Line Number (for Single CO)

Selects the outside (CO) line to be accessed.

**Value Range**

1–8

**Programming Manual References**

9.2.4 Flexible Buttons [2-4]—Extension jack

### CO Group Number (for Group CO)

Selects the outside (CO) line group to be accessed.

### **Value Range**

1–8

### **Programming Manual References**

9.2.4 Flexible Buttons [2-4]—Extension jack

## **Extension Number (for DSS)**

Selects the number of the extension to be accessed.

### **Value Range**

Extension no. and name specified in **Ext. no.** and **Name** on the **9.1.3 Numbering Plan [1-3]** screen

### **Programming Manual References**

9.1.3 Numbering Plan [1-3]—Ext. no., Name

9.2.4 Flexible Buttons [2-4]—Extension jack

## **Dial (for One-touch Dialing)**

Specifies the number to be dialed.

### **Value Range**

Max. 24 digits (consisting of 0–9, \*, #, P [pause], F [flash/recall], and [ ] [secret])

### **Programming Manual References**

9.2.4 Flexible Buttons [2-4]—Extension jack

## **VM Extension Number (for 2-way Record)**

Selects the voice mail extension number.

### **Value Range**

Extension no. and name specified in **Ext. no.** and **Name** on the **9.1.3 Numbering Plan [1-3]** screen

### **Programming Manual References**

9.1.3 Numbering Plan [1-3]—Ext. no., Name

9.2.4 Flexible Buttons [2-4]—Extension jack

## **VM Extension Number (for 2-way Transfer)**

Selects the voice mail extension number.

### **Value Range**

Extension no. and name specified in **Ext. no.** and **Name** on the **9.1.3 Numbering Plan [1-3]** screen

### **Programming Manual References**

9.1.3 Numbering Plan [1-3]—Ext. no., Name

9.2.4 Flexible Buttons [2-4]—Extension jack

## VM Extension Number (for Voice Mail Transfer)

Selects the voice mail extension number.

### Value Range

Extension no. and name specified in **Ext. no.** and **Name** on the **9.1.3 Numbering Plan [1-3]** screen

### Programming Manual References

- 9.1.3 Numbering Plan [1-3]—Ext. no., Name
- 9.2.4 Flexible Buttons [2-4]—Extension jack

## Extension Number (for Another Extension Message Waiting)

Selects the extension number of another extension for which messages are checked.

### Value Range

Extension no. and name specified in **Ext. no.** and **Name** on the **9.1.3 Numbering Plan [1-3]** screen

### Programming Manual References

- 9.1.3 Numbering Plan [1-3]—Ext. no., Name
- 9.2.4 Flexible Buttons [2-4]—Extension jack

## 9.2.6 Flexible Buttons [2-4] PF buttons

Each Programmable Feature (PF) button can be customized to access a certain feature with a one-touch operation. A maximum of 12 PF buttons can be customized for each extension. Select the desired extension from the **Extension jack** list on the **9.2.4 Flexible Buttons [2-4]** screen.

Personal Speed Dialing numbers (0–9) correspond to the numbers (F1–F10) of PF buttons as One-touch Dialing numbers.

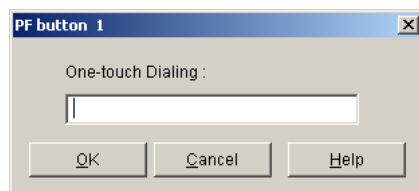

### One-touch Dialing

Specifies the number to be dialed.

### Value Range

Max. 24 digits (consisting of 0–9, \*, #, P [pause], F [flash/recall], and [ ] [secret])

### Programming Manual References

- 9.2.4 Flexible Buttons [2-4]—Extension jack

### Operating Manual References

- 1.3.64 One-touch Dialing

## 9.2.7 Flexible Buttons [2-4] Message button

The MESSAGE button can be customized to access a certain feature with a one-touch operation. Select the desired extension from the **Extension jack** list on the **9.2.4 Flexible Buttons [2-4]** screen. Depending on the button type, additional parameters are required as follows:

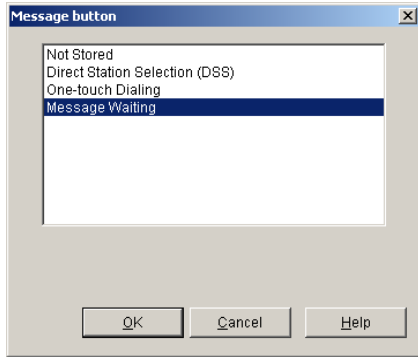

### Extension Number (for DSS)

Selects the number of an extension to be accessed.

#### Value Range

Extension no. and name specified in **Ext. no.** and **Name** on the **9.1.3 Numbering Plan [1-3]** screen

#### Programming Manual References

- 9.1.3 Numbering Plan [1-3]—Ext. no., Name
- 9.2.4 Flexible Buttons [2-4]—Extension jack

### Dial (for One-touch Dialing)

Specifies the number to be dialed.

#### Value Range

Max. 24 digits (consisting of 0–9, \*, #, P [pause], F [flash/recall], and [ ] [secret])

#### Programming Manual References

- 9.2.4 Flexible Buttons [2-4]—Extension jack

## 9.2.8 DSS Console [2-5]

A Direct Station Selection (DSS) Console can be used in conjunction with a proprietary telephone (PT). A maximum of 2 DSS Consoles can be connected to the PBX. Each flexible DSS/Programmable Feature (PF) button can be customized to allow one-touch access to a certain feature. The desired button settings of one DSS Console can be copied to the other DSS Console. Select the DSS Console that has the settings to copy to the other DSS Console from the **DSS Console No.** list, then click **Copy to DSS X** (X=1 or 2).

It is not possible to select the same extension jack number 2 times in either **Console Port** or **Pair Extension**. In addition, an extension jack number already assigned as a DSS Console cannot be selected in **Pair Extension**.

Clicking a DSS button opens the **9.2.9 DSS Console [2-5] DSS buttons** screen, which allows you to specify the feature to be assigned to a flexible DSS button on the selected DSS Console.

Clicking a PF button opens the **9.2.10 DSS Console [2-5] PF buttons** screen, which allows you to specify the feature to be assigned to a PF button on the selected DSS Console.

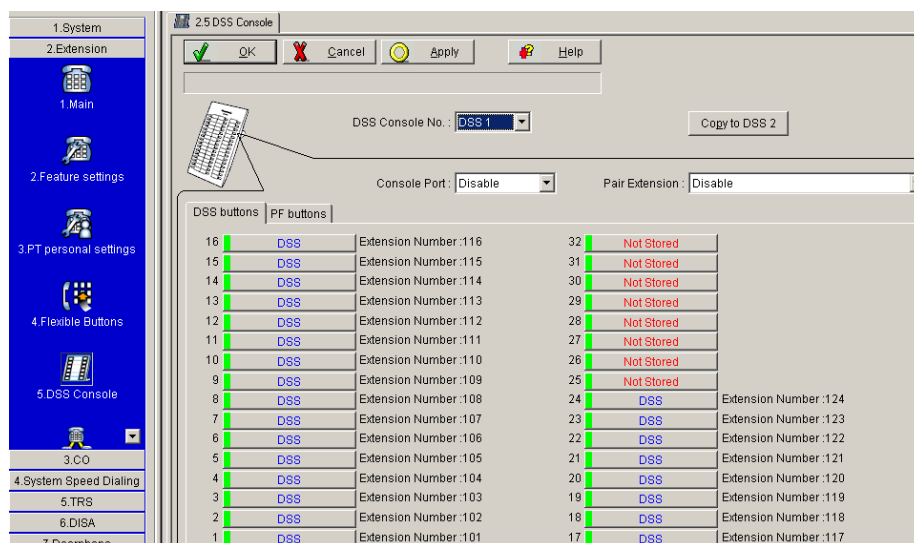

### DSS Console No.

Selects the DSS Console number.

### Value Range

DSS 1, DSS 2

### Feature Manual References

1.1.54 Extension Jack Configuration

1.1.59 Fixed Buttons

### Console Port

Selects the number of the extension jack that the DSS Console is connected to. It is not possible to select jack 01 as jack 01 is the manager extension.

### Default

Disable

### **Value Range**

Disable, Jack 02–24

### **Programming Manual References**

[003] DSS Console Jack Assignment

### **Feature Manual References**

1.1.54 Extension Jack Configuration

1.1.59 Fixed Buttons

## **Pair Extension**

Selects the extension number of the PT to be used in pair with the DSS Console. The extension number and name are shown with the jack number.

### **Default**

Disable

### **Value Range**

Disable, Jack 01–24 (Extension no. and name specified in **Ext. no.** and **Name** on the **9.1.3 Numbering Plan [1-3]** screen)

### **Programming Manual References**

[004] Console Paired Telephone

9.1.3 Numbering Plan [1-3]—Ext. no., Name

### **Feature Manual References**

1.1.54 Extension Jack Configuration

1.1.59 Fixed Buttons

## **DSS buttons**

Specifies the feature to be assigned to the flexible DSS button.

### **Default**

Button 1–24: DSS (Extension Number 101–124), Button 25–32: Not Stored

### **Value Range**

Not Stored, Direct Station Selection (DSS), One-touch Dialing, Extension Lock, Day, Night, Lunch, 2-way Record, 2-way Transfer, Live Call Screening (LCS), LCS Cancel, Voice Mail Transfer, Another Extension Message Waiting

### **Programming Manual References**

9.2.9 DSS Console [2-5] DSS buttons

### **Feature Manual References**

1.1.61 Flexible Buttons

## Operating Manual References

### 3.1.3 Flexible Button Assignment

## PF buttons

Specifies the feature to be assigned to the flexible PF button.

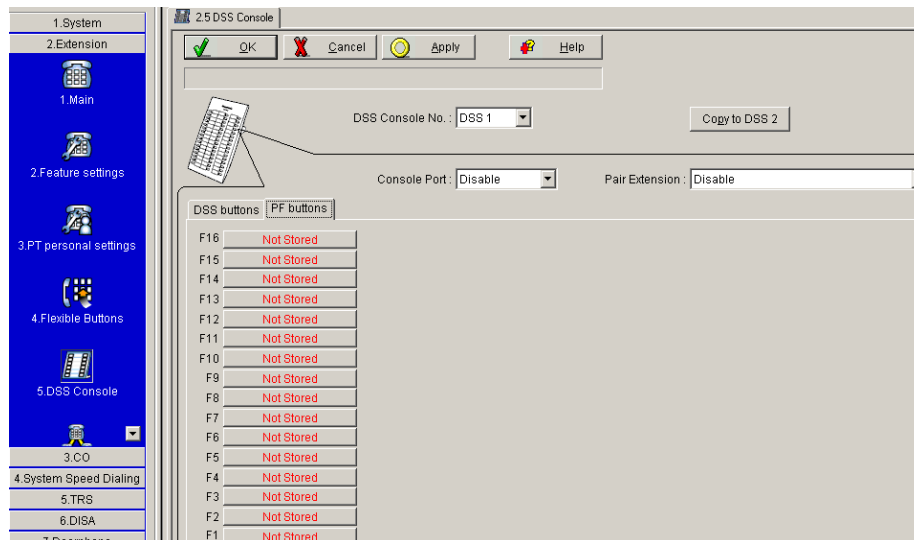

## Default

All buttons: Not Stored

## Value Range

Not Stored, One-touch Dialing

## Programming Manual References

9.2.10 DSS Console [2-5] PF buttons

## Feature Manual References

1.1.61 Flexible Buttons

## Operating Manual References

3.1.3 Flexible Button Assignment

## 9.2.9 DSS Console [2-5] DSS buttons

Each Direct Station Selection (DSS) button can be customized to access a certain feature with a one-touch operation. A maximum of 32 DSS buttons can be customized for each DSS Console. Select the desired DSS Console from the **DSS Console No.** list on the **9.2.8 DSS Console [2-5]** screen. Depending on the button type, additional parameters are required as follows:

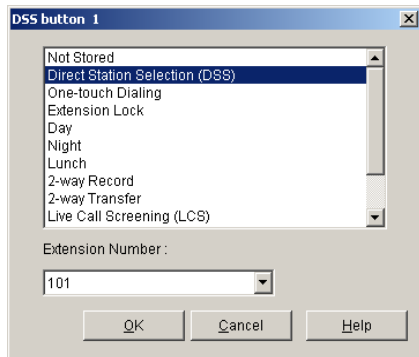

### Extension Number (for Extension Lock)

Selects the extension number of the extension that is locked.

#### Value Range

Extension no. and name specified in **Ext. no.** and **Name** on the **9.1.3 Numbering Plan [1-3]** screen

#### Programming Manual References

- 9.1.3 Numbering Plan [1-3]—Ext. no., Name
- 9.2.8 DSS Console [2-5]—DSS Console No.

### Extension Number (for Another Extension Message Waiting)

Selects the extension number of another extension for which messages are checked.

#### Value Range

Extension no. and name specified in **Ext. no.** and **Name** on the **9.1.3 Numbering Plan [1-3]** screen

#### Programming Manual References

- 9.1.3 Numbering Plan [1-3]—Ext. no., Name
- 9.2.8 DSS Console [2-5]—DSS Console No.

### VM Extension Number (for 2-way Record)

Selects the voice mail extension number.

#### Value Range

Extension no. and name specified in **Ext. no.** and **Name** on the **9.1.3 Numbering Plan [1-3]** screen

#### Programming Manual References

- 9.1.3 Numbering Plan [1-3]—Ext. no., Name

9.2.8 DSS Console [2-5]—DSS Console No.

### **VM Extension Number (for 2-way Transfer)**

Selects the voice mail extension number.

#### **Value Range**

Extension no. and name specified in **Ext. no.** and **Name** on the **9.1.3 Numbering Plan [1-3]** screen

#### **Programming Manual References**

9.1.3 Numbering Plan [1-3]—Ext. no., Name

9.2.8 DSS Console [2-5]—DSS Console No.

### **VM Extension Number (for Voice Mail Transfer)**

Selects the voice mail extension number.

#### **Value Range**

Extension no. and name specified in **Ext. no.** and **Name** on the **9.1.3 Numbering Plan [1-3]** screen

#### **Programming Manual References**

9.1.3 Numbering Plan [1-3]—Ext. no., Name

9.2.8 DSS Console [2-5]—DSS Console No.

### **Extension Number (for DSS)**

Selects the number of an extension to be accessed.

#### **Value Range**

Extension no. and name specified in **Ext. no.** and **Name** on the **9.1.3 Numbering Plan [1-3]** screen

#### **Programming Manual References**

9.1.3 Numbering Plan [1-3]—Ext. no., Name

9.2.8 DSS Console [2-5]—DSS Console No.

### **Dial (for One-touch Dialing)**

Specifies the number to be dialed.

#### **Value Range**

Max. 24 digits (consisting of 0–9, \*, #, P [pause], -, F [flash/recall], and [ ] [secret])

#### **Programming Manual References**

9.2.8 DSS Console [2-5]—DSS Console No.

## 9.2.10 DSS Console [2-5] PF buttons

Each Programmable Feature (PF) button can be customized to access a certain feature with a one-touch operation. A maximum of 16 PF buttons can be customized for each Direct Station Selection (DSS) Console. Select the desired DSS Console from the **DSS Console No.** list on the **9.2.8 DSS Console [2-5]** screen.

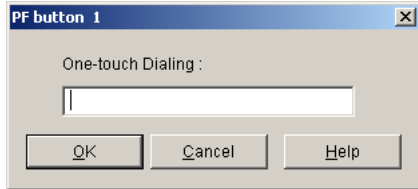

### One-touch Dialing

Specifies the number to be dialed.

### Value Range

Max. 24 digits (consisting of 0–9, \*, #, P [pause], F [flash/recall], and [ ] [secret])

### Programming Manual References

9.2.8 DSS Console [2-5]—DSS Console No.

### Operating Manual References

1.3.64 One-touch Dialing

## 9.2.11 Extension Group [2-6]

Extensions can be grouped into 8 extension groups.

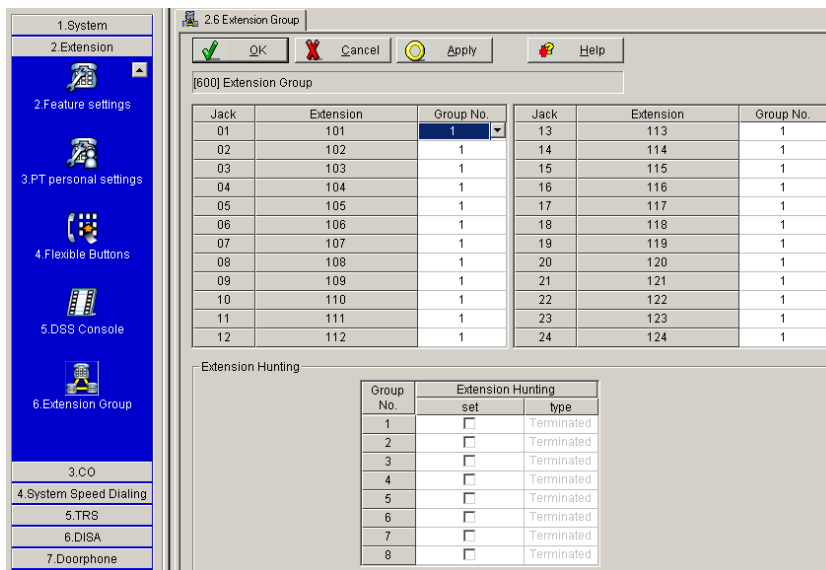

**Jack**

Indicates the jack number (reference only).

**Value Range**

01–24

**Extension**

Indicates the extension number and name (reference only).

**Value Range**

Extension no. and name specified in **Ext. no.** and **Name** on the **9.1.3 Numbering Plan [1-3]** screen

**Programming Manual References**

9.1.3 Numbering Plan [1-3]—Ext. no., Name

**Group No.**

Selects the extension group to which the extension belongs.

**Default**

All jacks: Group No. 1

**Value Range**

1–8

**Programming Manual References**

[600] Extension Group

**Feature Manual References**

- 1.1.21 Call Pickup, Group
- 1.1.42 Direct Inward System Access (DISA) Ring
- 1.1.53 Extension Group
- 1.1.67 Idle Extension Hunting
- 1.1.96 Paging—Group

**Extension Hunting—Group No.**

Indicates the extension group number (reference only).

**Value Range**

1–8

**Extension Hunting—Extension Hunting**

Enables the redirection of calls to an idle member of the same extension group when the called extension is busy. If enabled, the hunting type for the group can be selected.

**Default**

All Group Numbers: Off [Terminated (when checked)]

**Value Range**

set, type

set: On (checked), Off (unchecked)

type: Circular (Circulates until the call is answered), Terminated (Terminates at the last extension)

**Programming Manual References**

[100] Hunting Group Set

[101] Hunting Type

**Feature Manual References**

1.1.67 Idle Extension Hunting

## 9.3 CO [3]

### 9.3.1 Line Mode [3-1]

The distribution method of incoming outside (CO) line calls can be programmed for each outside (CO) line depending on the time service mode (day/night/lunch).

CO	Mode of incoming CO calls					
	Day		Night		Lunch	
	type	detail	type	detail	type	detail
1	Normal	---	Normal	---	Normal	---
2	Normal	---	Normal	---	Normal	---
3	Normal	---	Normal	---	Normal	---
4	Normal	---	Normal	---	Normal	---
5	Normal	---	Normal	---	Normal	---
6	Normal	---	Normal	---	Normal	---
7	Normal	---	Normal	---	Normal	---
8	Normal	---	Normal	---	Normal	---

**CO**

Indicates the outside (CO) line port number (reference only).

**Value Range**

1–8

**Mode of incoming CO calls—Day, Night, Lunch**

Selects the distribution method for incoming outside (CO) line calls in each time service mode.

Depending on the distribution method selected, it may also be necessary to select a specific destination.

**Default**

All outside (CO) lines: Normal

## Value Range

Normal, DIL (Jack 01–24), DISA (OGM 1–8), Modem, BV (BV 01–24)

## Programming Manual References

[414-416] CO Line Mode—Day/Night/Lunch

## Feature Manual References

- 1.1.8 Built-in Voice Message (BV)
- 1.1.40 Direct In Line (DIL)
- 1.1.41 Direct Inward System Access (DISA)
- 1.1.99 PC Programming

## 9.3.2 Incoming / Outgoing [3-2]

The authorization to make or receive outside (CO) line calls can be programmed for each extension. The extension settings of an outside (CO) line can be copied to other outside (CO) lines. Select the outside (CO) line whose settings you want to copy to other outside (CO) lines from the **CO Line Number** list, then click **Copy**.

Jack	Extension	Ringing for incoming CO calls						Outgoing Call		
		Day		Night		Lunch		Day	Night	Lunch
		Ring	Start Time	Ring	Start Time	Ring	Start Time			
01	101	<input checked="" type="checkbox"/>	Immediate	<input checked="" type="checkbox"/>	Immediate	<input checked="" type="checkbox"/>	Immediate	<input checked="" type="checkbox"/>	<input checked="" type="checkbox"/>	<input checked="" type="checkbox"/>
02	102	<input checked="" type="checkbox"/>	Immediate	<input checked="" type="checkbox"/>	Immediate	<input checked="" type="checkbox"/>	Immediate	<input checked="" type="checkbox"/>	<input checked="" type="checkbox"/>	<input checked="" type="checkbox"/>
03	103	<input checked="" type="checkbox"/>	Immediate	<input checked="" type="checkbox"/>	Immediate	<input checked="" type="checkbox"/>	Immediate	<input checked="" type="checkbox"/>	<input checked="" type="checkbox"/>	<input checked="" type="checkbox"/>
04	104	<input checked="" type="checkbox"/>	Immediate	<input checked="" type="checkbox"/>	Immediate	<input checked="" type="checkbox"/>	Immediate	<input checked="" type="checkbox"/>	<input checked="" type="checkbox"/>	<input checked="" type="checkbox"/>
05	105	<input checked="" type="checkbox"/>	Immediate	<input checked="" type="checkbox"/>	Immediate	<input checked="" type="checkbox"/>	Immediate	<input checked="" type="checkbox"/>	<input checked="" type="checkbox"/>	<input checked="" type="checkbox"/>
06	106	<input checked="" type="checkbox"/>	Immediate	<input checked="" type="checkbox"/>	Immediate	<input checked="" type="checkbox"/>	Immediate	<input checked="" type="checkbox"/>	<input checked="" type="checkbox"/>	<input checked="" type="checkbox"/>
07	107	<input checked="" type="checkbox"/>	Immediate	<input checked="" type="checkbox"/>	Immediate	<input checked="" type="checkbox"/>	Immediate	<input checked="" type="checkbox"/>	<input checked="" type="checkbox"/>	<input checked="" type="checkbox"/>
08	108	<input checked="" type="checkbox"/>	Immediate	<input checked="" type="checkbox"/>	Immediate	<input checked="" type="checkbox"/>	Immediate	<input checked="" type="checkbox"/>	<input checked="" type="checkbox"/>	<input checked="" type="checkbox"/>
09	109	<input checked="" type="checkbox"/>	Immediate	<input checked="" type="checkbox"/>	Immediate	<input checked="" type="checkbox"/>	Immediate	<input checked="" type="checkbox"/>	<input checked="" type="checkbox"/>	<input checked="" type="checkbox"/>
10	110	<input checked="" type="checkbox"/>	Immediate	<input checked="" type="checkbox"/>	Immediate	<input checked="" type="checkbox"/>	Immediate	<input checked="" type="checkbox"/>	<input checked="" type="checkbox"/>	<input checked="" type="checkbox"/>
11	111	<input checked="" type="checkbox"/>	Immediate	<input checked="" type="checkbox"/>	Immediate	<input checked="" type="checkbox"/>	Immediate	<input checked="" type="checkbox"/>	<input checked="" type="checkbox"/>	<input checked="" type="checkbox"/>
12	112	<input checked="" type="checkbox"/>	Immediate	<input checked="" type="checkbox"/>	Immediate	<input checked="" type="checkbox"/>	Immediate	<input checked="" type="checkbox"/>	<input checked="" type="checkbox"/>	<input checked="" type="checkbox"/>
13	113	<input checked="" type="checkbox"/>	Immediate	<input checked="" type="checkbox"/>	Immediate	<input checked="" type="checkbox"/>	Immediate	<input checked="" type="checkbox"/>	<input checked="" type="checkbox"/>	<input checked="" type="checkbox"/>
14	114	<input checked="" type="checkbox"/>	Immediate	<input checked="" type="checkbox"/>	Immediate	<input checked="" type="checkbox"/>	Immediate	<input checked="" type="checkbox"/>	<input checked="" type="checkbox"/>	<input checked="" type="checkbox"/>
15	115	<input checked="" type="checkbox"/>	Immediate	<input checked="" type="checkbox"/>	Immediate	<input checked="" type="checkbox"/>	Immediate	<input checked="" type="checkbox"/>	<input checked="" type="checkbox"/>	<input checked="" type="checkbox"/>
16	116	<input checked="" type="checkbox"/>	Immediate	<input checked="" type="checkbox"/>	Immediate	<input checked="" type="checkbox"/>	Immediate	<input checked="" type="checkbox"/>	<input checked="" type="checkbox"/>	<input checked="" type="checkbox"/>
17	117	<input checked="" type="checkbox"/>	Immediate	<input checked="" type="checkbox"/>	Immediate	<input checked="" type="checkbox"/>	Immediate	<input checked="" type="checkbox"/>	<input checked="" type="checkbox"/>	<input checked="" type="checkbox"/>
18	118	<input checked="" type="checkbox"/>	Immediate	<input checked="" type="checkbox"/>	Immediate	<input checked="" type="checkbox"/>	Immediate	<input checked="" type="checkbox"/>	<input checked="" type="checkbox"/>	<input checked="" type="checkbox"/>
19	119	<input checked="" type="checkbox"/>	Immediate	<input checked="" type="checkbox"/>	Immediate	<input checked="" type="checkbox"/>	Immediate	<input checked="" type="checkbox"/>	<input checked="" type="checkbox"/>	<input checked="" type="checkbox"/>
20	120	<input checked="" type="checkbox"/>	Immediate	<input checked="" type="checkbox"/>	Immediate	<input checked="" type="checkbox"/>	Immediate	<input checked="" type="checkbox"/>	<input checked="" type="checkbox"/>	<input checked="" type="checkbox"/>
21	121	<input checked="" type="checkbox"/>	Immediate	<input checked="" type="checkbox"/>	Immediate	<input checked="" type="checkbox"/>	Immediate	<input checked="" type="checkbox"/>	<input checked="" type="checkbox"/>	<input checked="" type="checkbox"/>
22	122	<input checked="" type="checkbox"/>	Immediate	<input checked="" type="checkbox"/>	Immediate	<input checked="" type="checkbox"/>	Immediate	<input checked="" type="checkbox"/>	<input checked="" type="checkbox"/>	<input checked="" type="checkbox"/>
23	123	<input checked="" type="checkbox"/>	Immediate	<input checked="" type="checkbox"/>	Immediate	<input checked="" type="checkbox"/>	Immediate	<input checked="" type="checkbox"/>	<input checked="" type="checkbox"/>	<input checked="" type="checkbox"/>
24	124	<input checked="" type="checkbox"/>	Immediate	<input checked="" type="checkbox"/>	Immediate	<input checked="" type="checkbox"/>	Immediate	<input checked="" type="checkbox"/>	<input checked="" type="checkbox"/>	<input checked="" type="checkbox"/>

## CO Line Number

Specifies the outside (CO) line port number.

## Value Range

1–8

## Jack

Indicates the jack number (reference only).

**Value Range**

01–24

**Extension**

Indicates the extension number and name (reference only).

**Value Range**

Extension no. and name specified in **Ext. no.** and **Name** on the **9.1.3 Numbering Plan [1-3]** screen

**Programming Manual References**

9.1.3 Numbering Plan [1-3]—Ext. no., Name

**Ring for incoming CO calls—Day, Night, Lunch**

Selects whether the extension will ring or not for incoming outside (CO) line calls in each time service mode. If the extension is set to ring, the ring delay can be specified.

**Default**

All outside (CO) lines—all jacks: On (Immediate)

**Value Range**

Ring, Start Time

Ring: On (checked), Off (unchecked)

Start Time: Immediate, 5 s, 10 s, 15 s

**Programming Manual References**

[408-410] Flexible Ringing—Day/Night/Lunch

[411-413] Delayed Ringing—Day/Night/Lunch

**Feature Manual References**

1.1.42 Direct Inward System Access (DISA) Ring

1.1.75 Line Preference—Incoming

1.1.90 Outside (CO) Line Ringing Selection

1.1.109 Ringing, Delayed

**Outgoing Call—Day, Night, Lunch**

Specifies which extensions can make outside (CO) line calls in each time service mode. It is impossible to disable (Off) all extensions for all outside (CO) lines in each time service mode. In each mode, at least one extension must be allowed to make an outside (CO) line call.

**Default**

All outside (CO) lines—all jacks: On

**Value Range**

On (checked), Off (unchecked)

## Programming Manual References

[405-407] Flexible Outward Dialing—Day/Night/Lunch

## Feature Manual References

1.1.71 Line Access, Outside (CO) Line—SUMMARY

1.1.76 Line Preference—Outgoing

### 9.3.3 Detail [3-3]

Various settings can be programmed for each outside (CO) line.

The screenshot shows the '3.3 Detail' configuration window for CO Line Connection. The window has a sidebar on the left with navigation options: 1.System, 2.Extension, 3.CO, 1.Line Mode, 2.Incoming / Outgoing, 3.Detail, and 4.Local Carrier-based VM. The main area contains two tables.

**[400] CO Line Connection**

CO	Connection	Dial Mode	Pulse Speed	Host PBX Access Codes								CO Line Group	Pause Time
				1	2	3	4	5	6	7	8		
1	<input checked="" type="checkbox"/>	DTMF	10 pps									1	1.5 s
2	<input checked="" type="checkbox"/>	DTMF	10 pps									2	1.5 s
3	<input checked="" type="checkbox"/>	DTMF	10 pps									3	1.5 s
4	<input checked="" type="checkbox"/>	DTMF	10 pps									4	1.5 s
5	<input checked="" type="checkbox"/>	DTMF	10 pps									5	1.5 s
6	<input checked="" type="checkbox"/>	DTMF	10 pps									6	1.5 s
7	<input checked="" type="checkbox"/>	DTMF	10 pps									7	1.5 s
8	<input checked="" type="checkbox"/>	DTMF	10 pps									8	1.5 s

CO	Flash/Recall Time	Automatic Line Access	CPC Signal Detection		Disconnect Time	Ring Tone Pattern
			Incoming	Outgoing		
1	600 ms	<input checked="" type="checkbox"/>	350 ms	<input type="checkbox"/>	1.5 s	Single
2	600 ms	<input checked="" type="checkbox"/>	350 ms	<input type="checkbox"/>	1.5 s	Single
3	600 ms	<input checked="" type="checkbox"/>	350 ms	<input type="checkbox"/>	1.5 s	Single
4	600 ms	<input checked="" type="checkbox"/>	350 ms	<input type="checkbox"/>	1.5 s	Single
5	600 ms	<input checked="" type="checkbox"/>	350 ms	<input type="checkbox"/>	1.5 s	Single
6	600 ms	<input checked="" type="checkbox"/>	350 ms	<input type="checkbox"/>	1.5 s	Single
7	600 ms	<input checked="" type="checkbox"/>	350 ms	<input type="checkbox"/>	1.5 s	Single
8	600 ms	<input checked="" type="checkbox"/>	350 ms	<input type="checkbox"/>	1.5 s	Single

## CO

Indicates the outside (CO) line port number (reference only).

## Value Range

1–8

## Connection

Specifies which outside (CO) lines are connected to the PBX.

Note that the numbers of unconnected outside (CO) lines should be unchecked (Off). The PBX seizes an outside (CO) line from the highest outside (CO) line number when selecting an idle outside (CO) line automatically. If an unconnected outside (CO) line number is checked (On) and is higher than any connected outside (CO) line number, the PBX will try to seize the unconnected outside (CO) line.

## Default

All outside (CO) lines: On

## Value Range

On (checked), Off (unchecked)

### **Programming Manual References**

[400] CO Line Connection

### **Feature Manual References**

1.1.71 Line Access, Outside (CO) Line—SUMMARY

1.1.76 Line Preference—Outgoing

## **Dial Mode**

Selects the type of signal used to dial out using an outside (CO) line.

### **Default**

All outside (CO) lines: DTMF

### **Value Range**

DTMF, Pulse, Call Blocking

### **Programming Manual References**

[401] Dial Mode

### **Feature Manual References**

1.1.39 Dial Type Selection

## **Pulse Speed**

Selects the speed at which pulse signals are sent to the outside (CO) lines for which **Dial Mode** on this screen is set to **Pulse** or **Call Blocking**.

### **Default**

All outside (CO) lines: 10 pps

### **Value Range**

10 pps, 20 pps

### **Programming Manual References**

[402] Pulse Speed

### **Feature Manual References**

1.1.39 Dial Type Selection

## **Host PBX Access Codes**

Specifies the Host PBX Access code used to access an outside (CO) line from the host PBX.

### **Default**

All outside (CO) lines: — (Not stored)

**Value Range**

Max. 8 codes (1 or 2 digits consisting of 0–9, \*, and #)

**Programming Manual References**

[403] Host PBX Access Code

**Feature Manual References**

1.1.65 Host PBX Access Code (Access Code to the Telephone Company from a Host PBX)

**CO Line Group**

Selects the outside (CO) line group that each outside (CO) line is assigned to.

**Default**

CO 1–8 = CO Line Group 1–8 (e.g., CO 1: CO Line Group 1, CO 2: CO Line Group 2)

**Value Range**

1–8

**Programming Manual References**

[404] CO Line Group Number

**Feature Manual References**

1.1.73 Line Access, Outside (CO) Line Group

1.1.89 Outside (CO) Line Group

**Pause Time**

Selects the length of a pause inserted in dialing.

**Default**

All outside (CO) lines: 1.5 s

**Value Range**

1.5 s, 2.5 s, 3.5 s, 4.5 s

**Programming Manual References**

[417] Pause Time

**Feature Manual References**

1.1.65 Host PBX Access Code (Access Code to the Telephone Company from a Host PBX)

1.1.98 Pause Insertion

**Flash/Recall Time**

Selects the length of a flash/recall signal.

**Default**

All outside (CO) lines: 600 ms

**Value Range**

80 ms, 100 ms, 160 ms, 300 ms, 600 ms, 900 ms, 1200 ms

**Programming Manual References**

[418] Flash/Recall Time

**Feature Manual References**

1.1.56 External Feature Access (EFA)

1.1.60 Flash/Recall

**Automatic Line Access**

Specifies which outside (CO) line is seized automatically when an extension user dials the Automatic Line Access number (9).

**Default**

All outside (CO) lines: On

**Value Range**

On (checked), Off (unchecked)

**Programming Manual References**

[419] Automatic Designated Line Access

**Feature Manual References**

1.1.72 Line Access, Automatic

1.1.76 Line Preference—Outgoing

**CPC Signal Detection—Incoming**

Selects the length of time required by the PBX to detect a calling party control (CPC) signal from an incoming outside (CO) line call before disconnecting the line.

**Default**

All outside (CO) lines: 350 ms

**Value Range**

Disable, 22–614 ms in 8 ms increments

**Programming Manual References**

[420] CPC Signal Detection—Incoming

**Feature Manual References**

1.1.31 Calling Party Control (CPC) Signal Detection

## CPC Signal Detection—Outgoing

Enables the PBX to detect a CPC signal from outgoing outside (CO) line calls. If disabled, CPC signal detection is only activated during an incoming outside (CO) line call.

### Default

All outside (CO) lines: Off

### Value Range

On (checked), Off (unchecked)

### Programming Manual References

[421] CPC Signal Detection—Outgoing

### Feature Manual References

1.1.31 Calling Party Control (CPC) Signal Detection

## Disconnect Time

Selects the length of the disconnect signal sent from the PBX to the telephone company or host PBX. The time you select must be longer than the requirements of your telephone company or host PBX.

### Default

All outside (CO) lines: 1.5 s

### Value Range

0.5 s, 1.5 s, 4.0 s

### Programming Manual References

[422] Disconnect Time

### Feature Manual References

1.1.60 Flash/Recall

## Ring Tone Pattern

Selects the ring tone pattern for incoming outside (CO) line calls. It is recommended that you set a different ring tone pattern from the ring tone patterns specified in **Extension—Ring Tone Pattern** on the **9.1.11 Detail [1-10]** screen and **Doorphone Ring Tone Pattern—Door 1–4** on the **9.7.2 Others [7-2]** screen.

### Default

All outside (CO) lines: Single

### Value Range

Single, Double, Triple

### Programming Manual References

[423] CO Line Ring Tone Pattern

9.1.11 Detail [1-10]—Extension—Ring Tone Pattern

## 9.7.2 Others [7-2]—Doorphone Ring Tone Pattern—Door 1–4

**Feature Manual References**

1.1.108 Ring Tone Pattern Selection

**9.3.4 Local Carrier-based VM [3-4]**

The PBX supports voice mail service, which is an answering system offered by the telephone company, that can notify the called party of a message waiting. The settings of an outside (CO) line can be copied to other outside (CO) lines. Select the outside (CO) line whose settings you want to copy to other outside (CO) lines from the **CO Line Number** list, then click **Copy**.

*This feature is available only for proprietary telephones (PTs).*

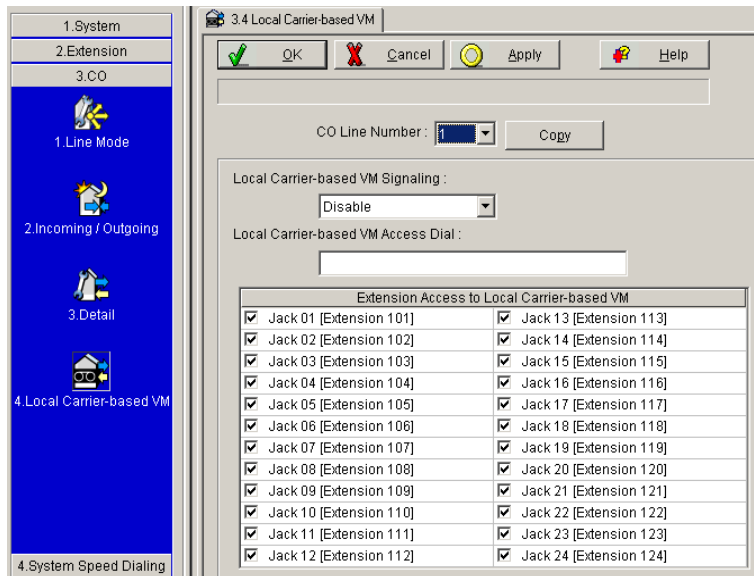
**CO Line Number**

Specifies the outside (CO) line port number.

**Value Range**

1–8

**Local Carrier-based VM Signaling**

Selects the type of signal that the PBX expects to receive from the telephone company's voice mail service. This signal indicates the presence or absence of voice mail messages in the mailbox.

**Default**

All outside (CO) lines: Disable

**Value Range**

Disable, Stutter dial tone method, FSK method

**Programming Manual References**

[435] Local Carrier-based Voice Mail Signaling

**Feature Manual References**

1.1.78 Local Carrier-based Voice Mail Service

**Local Carrier-based VM Access Dial**

Specifies the voice mail service access number. This program allows a PT user to access the telephone company's voice mail service when a message is left in the mailbox.

**Default**

All outside (CO) lines: — (Not stored)

**Value Range**

Max. 32 digits (consisting of 0–9, \*, #, P [pause], -, F [flash/recall], and [ ] [secret])

**Programming Manual References**

[436] Local Carrier-based Voice Mail Access Dial

**Feature Manual References**

1.1.78 Local Carrier-based Voice Mail Service

**Extension Access to Local Carrier-based VM**

Selects which extensions can access the voice mail service offered by the telephone company using each outside (CO) line. The extension number and name specified in **Ext. no.** and **Name** on the **9.1.3 Numbering Plan [1-3]** screen are shown with the jack number.

**Default**

All outside (CO) lines—all jacks: On

**Value Range**

On (checked), Off (unchecked)

**Programming Manual References**

[437] Extension Access to Local Carrier-based Voice Mail

9.1.3 Numbering Plan [1-3]—Ext. no., Name

**Feature Manual References**

1.1.78 Local Carrier-based Voice Mail Service

## 9.4 System Speed Dialing [4]

### 9.4.1 System Speed Dialing [4-1]

The System Speed Dialing table is used to store frequently dialed numbers. It is available for all extension users when making or receiving calls.

A maximum of 100 System Speed Dialing numbers (e.g., telephone numbers, feature numbers) can be programmed. Select the set of System Speed Dialing numbers to view and edit from the numeric tabs.

You can import or export the files of System Speed Dialing data by clicking **Import** or **Export**.

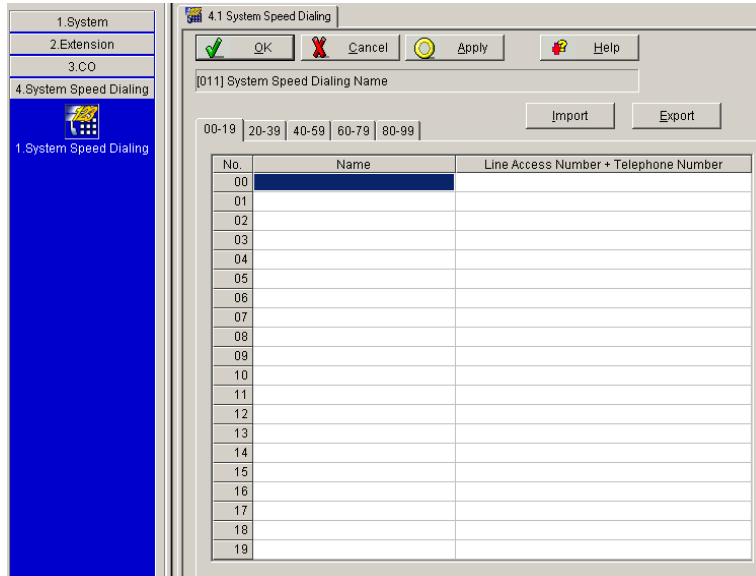

#### Import

Allows the files of System Speed Dialing data to be imported.

The files from which data can be imported are files that were previously saved at this or another compatible PBX with the Export operation, or comma-separated value (CSV) files that follow the same format.

Unsupported file types cannot be imported.

Follow the steps below to import data.

1. Click **Import**.  
The **Open** dialog box appears.
2. Navigate to the folder containing the system speed dialing data file you want to open.
3. Select a file to import.
4. Click **Open** to import the file.

#### Export

Allows the files of System Speed Dialing data to be exported as comma-separated value (CSV) files. These files can be used with the import operation to update another PBX.

An example of the format of the exported data file is as follows:

```

00, Tom Smith, Dial=0022334455
01, Panasonic, Dial=0223344556677
:
:

```

**Notes**

- The separator used in CSV files created using the Export operation is decided by the unit specified in List Separator, in the Windows Regional Options Control Panel.
- Even if the string "Dial=" is not included in a CSV file, the import operation can be performed.

Follow the steps below to export data.

1. Click **Export**.  
The **Save As** dialog box appears.
2. Navigate to the folder in which you want to save the file.
3. Enter a file name.
4. Click **Save** to export the file.

**No.**

Indicates the System Speed Dialing number (reference only).  
Each tab contains 20 System Speed Dialing numbers.

**Value Range**

00–99 (00–19, 20–39, 40–59, 60–79, 80–99)

**Name**

Specifies a name for the System Speed Dialing number.

**Default**

All System Speed Dialing names: — (Not stored)

**Value Range**

Max. 16 characters

**Programming Manual References**

[011] System Speed Dialing Name

**Feature Manual References**

1.1.113 System Speed Dialing

**Line Access Number + Telephone Number**

Specifies the telephone number (including the Outside (CO) Line Access number) or feature number assigned to the System Speed Dialing number.

**Default**

All System Speed Dialing numbers: — (Not stored)

**Value Range**

Max. 32 digits (consisting of 0–9, \*, #, P [pause], -, F [flash/recall], and [ ] [secret])

**Programming Manual References**

[001] System Speed Dialing Number

**Feature Manual References**

1.1.113 System Speed Dialing

## 9.5 TRS

### 9.5.1 Class of Service (COS) [5-1]

Each extension has a certain class of service (COS) assigned to it. The Toll Restriction (TRS) feature can be programmed to behave differently depending on each COS. A maximum of 5 COSs can be programmed.

Jack	Extension	Day	Night	Lunch
01	101	COS 1	COS 1	COS 1
02	102	COS 1	COS 1	COS 1
03	103	COS 1	COS 1	COS 1
04	104	COS 1	COS 1	COS 1
05	105	COS 1	COS 1	COS 1
06	106	COS 1	COS 1	COS 1
07	107	COS 1	COS 1	COS 1
08	108	COS 1	COS 1	COS 1
09	109	COS 1	COS 1	COS 1
10	110	COS 1	COS 1	COS 1
11	111	COS 1	COS 1	COS 1
12	112	COS 1	COS 1	COS 1
13	113	COS 1	COS 1	COS 1
14	114	COS 1	COS 1	COS 1
15	115	COS 1	COS 1	COS 1
16	116	COS 1	COS 1	COS 1
17	117	COS 1	COS 1	COS 1
18	118	COS 1	COS 1	COS 1
19	119	COS 1	COS 1	COS 1
20	120	COS 1	COS 1	COS 1
21	121	COS 1	COS 1	COS 1
22	122	COS 1	COS 1	COS 1
23	123	COS 1	COS 1	COS 1
24	124	COS 1	COS 1	COS 1

**Jack**

Indicates the jack number (reference only).

**Value Range**

01–24

**Extension**

Indicates the extension number and name (reference only).

**Value Range**

Extension no. and name specified in **Ext. no.** and **Name** on the **9.1.3 Numbering Plan [1-3]** screen

**Programming Manual References**

9.1.3 Numbering Plan [1-3]—Ext. no., Name

**Day, Night, Lunch**

Selects the TRS COS for each extension, applied to outside (CO) line calls in each time service mode.

**Default**

All jacks: COS 1

**Value Range**

COS 1–5

**Programming Manual References**

[601-603] TRS-COS—Day/Night/Lunch

**Feature Manual References**

1.1.32 Class of Service (COS)

1.1.117 Toll Restriction (TRS)

**9.5.2 Denied Codes [5-2]**

Toll Restriction (TRS) can prohibit certain extension users from making unauthorized outside (CO) line calls. Every extension is assigned to one of 5 classes of service (COSs) for each time service mode. COS 1 does not restrict calls (all outside (CO) line calls are allowed). COSs 2–5 are used to restrict calls according to the combination of **Denied Code** tables here and **Exception Code** tables in **9.5.3 Exception Codes [5-3]**. If a dialed number is not found in the applicable Denied Code tables, the call is made. A total maximum of 80 denied codes can be programmed.

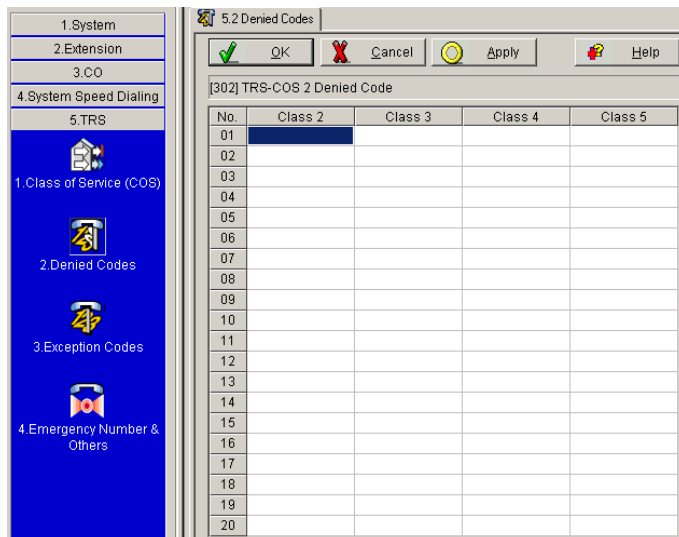

**No.**

Indicates the denied code number (reference only).

**Value Range**

01–20

**Class 2–5**

Specifies the toll-restricted numbers for classes 2–5.

**Default**

All codes: — (Not stored)

**Value Range**

Max. 11 digits (consisting of 0-9, \*, #, and x [wild card])

**Programming Manual References**

[302-305] TRS—COS 2-5 Denied Code

9.5.3 Exception Codes [5-3]

**Feature Manual References**

1.1.117 Toll Restriction (TRS)

## 9.5.3 Exception Codes [5-3]

Toll Restriction (TRS) can prohibit certain extension users from making unauthorized outside (CO) line calls. Every extension is assigned to one of 5 classes of Service (COSs) for each time service mode. COS 1 does not restrict calls (all outside (CO) line calls are allowed). COSs 2–5 are used to restrict calls according to the combination of **Denied Code** tables in **9.5.2 Denied Codes [5-2]** and **Exception Code** tables here. A call denied by the applicable Denied Code Tables is checked against the applicable Exception Code Tables, and if a match is found, the call is made. A maximum of 80 exception codes can be programmed. The available number of codes depends on the COS assigned to each extension.

No.	Classes 2-5	No.	Classes 2-4	No.	Classes 2-3	No.	Class 2
01		21		41		61	
02		22		42		62	
03		23		43		63	
04		24		44		64	
05		25		45		65	
06		26		46		66	
07		27		47		67	
08		28		48		68	
09		29		49		69	
10		30		50		70	
11		31		51		71	
12		32		52		72	
13		33		53		73	
14		34		54		74	
15		35		55		75	
16		36		56		76	
17		37		57		77	
18		38		58		78	
19		39		59		79	
20		40		60		80	

**No.**

Indicates the exception code number (reference only).

**Value Range**

01–80

01–20: Classes 2–5

21–40: Classes 2–4

41–60: Classes 2–3

61–80: Class 2

**Classes 2–5, Classes 2–4, Classes 2–3, Class 2**

Specifies the numbers to be exempted from TRS in each class range.

**Default**

All codes: — (Not stored)

**Value Range**

Max. 11 digits (consisting of 0–9, \*, #, and x [wild card])

**Programming Manual References**

[306] TRS—Exception Code

9.5.2 Denied Codes [5-2]

**Feature Manual References**

1.1.117 Toll Restriction (TRS)

## 9.5.4 Emergency Number & Others [5-4]

Any extension user can dial the programmed emergency numbers at any time after seizing an outside (CO) line. Any restrictions imposed on the extension, such as Toll Restriction (TRS), Account Code—Forced/Verify-All/Verify-Toll mode, and Extension Lock/Remote Extension Lock, are disregarded.

A maximum of 5 emergency numbers can be programmed.

Other optional TRS settings can be programmed.

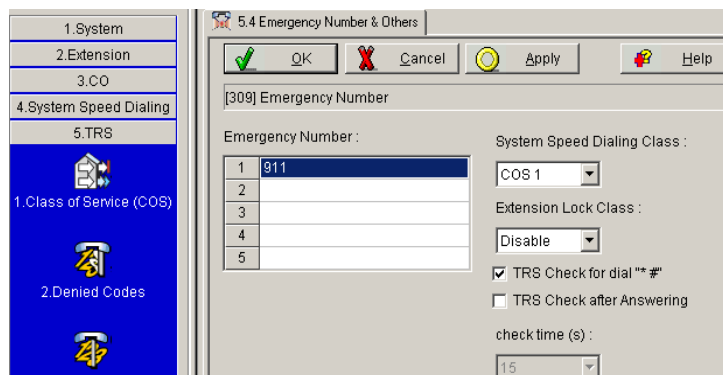

## Emergency Number

Specifies the numbers used for making emergency calls. It is not necessary to prefix the emergency number with an Outside (CO) Line Access number.

### Default

1: 911, 2–5: — (Not stored)

### Value Range

Max. 24 digits (consisting of 0–9)

### Programming Manual References

[309] Emergency Number

### Feature Manual References

1.1.49 Emergency Call

1.1.117 Toll Restriction (TRS)

## System Speed Dialing Class

Selects the class of service (COS) of System Speed Dialing numbers. Calls made using System Speed Dialing are restricted depending on the COS programmed here and the COS assigned to each extension.

### Default

COS 1

### Value Range

COS 1–5

### Programming Manual References

[301] TRS—System Speed Dialing Class

### Feature Manual References

1.1.113 System Speed Dialing

1.1.117 Toll Restriction (TRS)

## Extension Lock Class

Selects the COS of locked extensions.

### Default

Disable

### Value Range

Disable, COS 2–5

### Programming Manual References

[312] TRS—Extension Lock Class

**Feature Manual References**

- 1.1.55 Extension Lock
- 1.1.107 Remote Extension Lock
- 1.1.117 Toll Restriction (TRS)

**TRS Check for dial "\*#"**

Enables TRS to check for the user-dialed digits "\*" and "#". This is useful in preventing some unauthorized calls.

**Default**

On

**Value Range**

On (checked), Off (unchecked)

**Programming Manual References**

[125] TRS Check for \* and #

**Feature Manual References**

- 1.1.117 Toll Restriction (TRS)

**TRS Check after Answering**

Specifies whether the PBX checks DTMF (Dual Tone Multi-Frequency) signals when answering calls or not. If enabled, the length of time that the DTMF signal is checked can be specified.

**Default**

Off (15 s [when checked])

**Value Range**

On (checked), Off (unchecked)  
check time: 5 s, 10 s, 15 s, 20 s, 30 s, 60 s

**Programming Manual References**

- [966] TRS Check after Answering
- [967] TRS Check Time after Answering

## 9.6 DISA [6]

### 9.6.1 Automated Attendant [6-1]

Direct Inward System Access (DISA) Automated Attendant (AA) service allows a caller to dial a single-digit number (DISA AA number) and be connected to the desired party automatically. A maximum of 10 destinations that can be called by dialing a DISA AA number (0–9) can be programmed. The DISA AA Service supports up to 3 levels of DISA outgoing messages (OGMs).

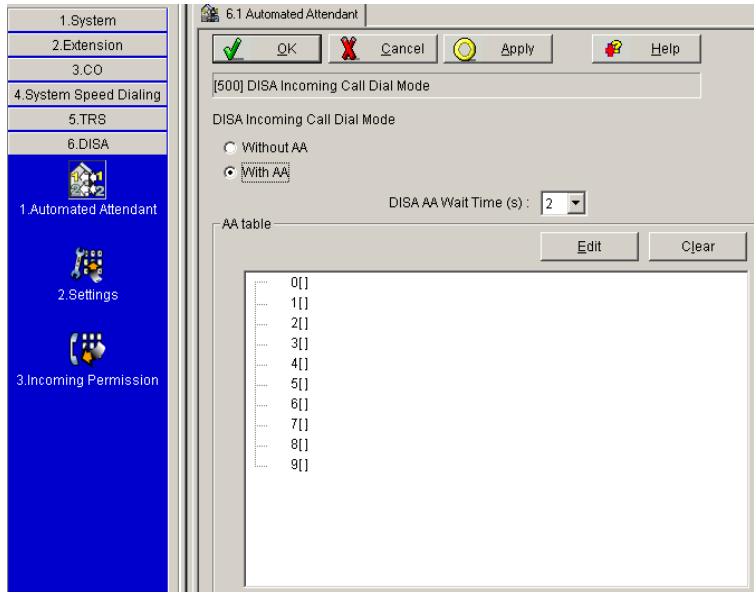

#### DISA Incoming Call Dial Mode

Selects the destination of an incoming outside (CO) line call via the DISA feature. If **DISA** is not selected in **Mode of incoming CO calls—Day, Night, Lunch** on the **9.3.1 Line Mode [3-1]** screen when you click **OK** or **Apply** after selecting **With AA** in this program, a warning message is displayed. Clicking **OK** displays, the corresponding screen.

#### Default

Without AA

#### Value Range

Without AA, With AA

Without AA: Available destinations are extension numbers, Outside (CO) Line Access numbers, and the Operator Call number

With AA: Available destinations are numbers available in "Without AA" mode and numbers specified in **AA table** on this screen.

#### Programming Manual References

[500] DISA Incoming Call Dial Mode

9.3.1 Line Mode [3-1]—Mode of incoming CO calls—Day, Night, Lunch

## Feature Manual References

1.1.41 Direct Inward System Access (DISA)

## DISA AA Wait Time

*This program is available only when **With AA** is selected in **DISA Incoming Call Dial Mode** on this screen.*

Specifies the length of time after entering a first digit in which the caller must dial the second digit before the DISA AA Service activates.

### Default

2 s

### Value Range

1–5 s

## Programming Manual References

[517] DISA AA Wait Time

## Feature Manual References

1.1.41 Direct Inward System Access (DISA)

## AA table

*This program is available only when **With AA** is selected in **DISA Incoming Call Dial Mode** on this screen.*

Specifies the destinations of the DISA AA numbers. To specify a destination for a DISA AA number, click **Edit** or double-click the AA number. To clear a setting, click it one time and click **Clear**.

You can also right-click to see the shortcut menu.

If you want to use an Outside (CO) Line Access number and/or Operator Call number in AA mode, do not assign AA number(s) that correspond to Outside (CO) Line Access or Operator Call numbers (9 and/or 0).

### Default

All AA numbers: — (Not stored)

### Value Range

0–9

## Programming Manual References

[501] DISA Built-in AA

## Feature Manual References

1.1.41 Direct Inward System Access (DISA)

## 9.6.2 Automated Attendant [6-1] AA dial

### AA dial

The Direct Inward System Access (DISA) Automated Attendant (AA) Service supports up to 3 levels of DISA outgoing messages (OGMs). *These settings are available only when **With AA** is selected in **DISA Incoming Call Dial Mode** on the **9.6.1 Automated Attendant [6-1]** screen.*

In the **AA dial** dialog box, the title is displayed as follows:

First level: AA dial "X"

Second level: AA dial "X-Y"

Third level: AA dial "X-Y-Z"

(X, Y, Z: 0–9)

Depending on the type of destination selected, it may also be necessary to select a specific destination (Extension/Extension Group). When you select **2-level AA** or **3-level AA** as the destination, the display shows how to record and playback through personal programming from the telephone. After you click **OK**, a minus sign (-) is displayed before the AA icon, and the possible sub-destinations **0 [ ]–9 [ ]** of the following level are displayed. When you click the minus sign (-), the sign changes back to the plus sign (+), and the list of sub-destinations is closed. In Interactive mode, when the selected DISA OGM has already been recorded, a horn graphic is displayed after the name of the menu option.

When you change the type of a destination from 2-level AA or 3-level AA to another setting, any associated DISA OGM will also be cleared. In addition, any items within the AA menu being removed will also be removed.

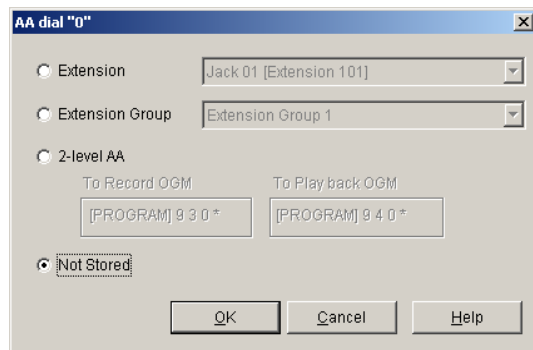

### Default

All AA numbers: — (Not stored)

### Value Range

Extension (Jack 01–24 [Extension no. and name specified in **Ext. no.** and **Name** on the **9.1.3 Numbering Plan [1-3]** screen]), Extension Group (Extension Group 1–8), 2- or 3-level AA [not available to select from 3-level AA], Not Stored

### Programming Manual References

[501] DISA Built-in AA

[540-549] 3-level AA Assignment

9.1.3 Numbering Plan [1-3]—Ext. no., Name

9.6.1 Automated Attendant [6-1]—DISA Incoming Call Dial Mode

## Feature Manual References

1.1.41 Direct Inward System Access (DISA)

## Operating Manual References

2.1.5 Outgoing Message (OGM) for DISA

### 9.6.3 Settings [6-2]

Direct Inward System Access (DISA) enables outside callers to access specific PBX features as if the caller were an extension user calling from within the PBX.

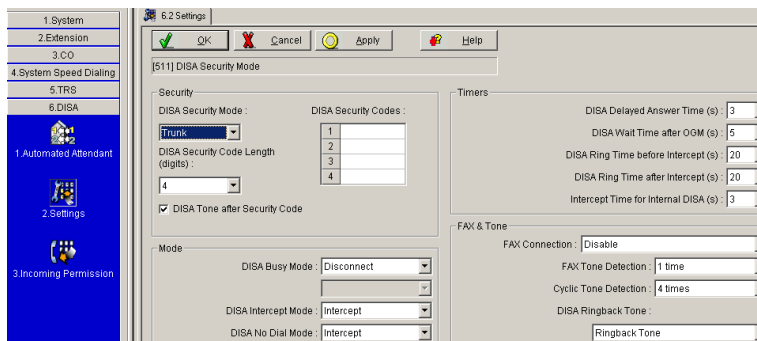

## Security—DISA Security Mode

Selects the DISA security mode to prevent unauthorized access to the PBX. In Trunk or All security mode, the caller is required to enter a DISA security code.

### Default

Trunk

### Value Range

None, Trunk, All

None: Intercom calls and outside (CO) line calls can be made.

Trunk: Intercom calls can be made. Outside (CO) line calls are restricted unless the DISA security code is entered.

All: All calls are restricted unless the DISA security code is entered.

## Programming Manual References

[511] DISA Security Mode

## Feature Manual References

1.1.41 Direct Inward System Access (DISA)

## Security—DISA Security Codes

Specifies the DISA security codes that must be entered when **Trunk** (a DISA security code is required to make an outside (CO) line call) or **All** (a DISA security code is required to make an intercom call or outside (CO) line call) is selected in **Security—DISA Security Mode** on this screen. The number of digits for DISA security codes is selected in **Security—DISA Security Code Length** on this screen.

**Default**

All codes: — (Not stored)

**Value Range**

4–10 digits (consisting of 0–9)

**Programming Manual References**

[512] DISA Security Code

**Feature Manual References**

1.1.41 Direct Inward System Access (DISA)

**Security—DISA Security Code Length**

Selects the number of digits for the DISA security codes. When this setting is changed, DISA security codes that have already been assigned will be cleared.

**Default**

4 digits

**Value Range**

4–10 digits

**Programming Manual References**

[530] DISA Security Code Digits

**Feature Manual References**

1.1.41 Direct Inward System Access (DISA)

**Security—DISA Tone after Security Code**

Enables the PBX to send a short beep to the caller when the entered number is the same as one of the DISA security codes.

**Default**

On

**Value Range**

On (checked), Off (unchecked)

**Programming Manual References**

[518] DISA Tone after Security Code

**Feature Manual References**

1.1.41 Direct Inward System Access (DISA)

## Mode—DISA Busy Mode

Selects how DISA calls are handled when a called extension or all called extensions in an extension group enabled in **Extension Hunting—Extension Hunting** on the **9.2.11 Extension Group [2-6]** screen are busy. When **DISA** is selected in this program, a DISA outgoing message (OGM) number can be specified.

### Default

Disconnect

### Value Range

Disconnect, Call Waiting, DISA (OGM 1–8)

### Programming Manual References

[506] DISA Busy Mode

9.2.11 Extension Group [2-6]—Extension Hunting—Extension Hunting

### Feature Manual References

1.1.41 Direct Inward System Access (DISA)

1.1.88 Outgoing Message (OGM) for DISA

## Mode—DISA Intercept Mode

Selects how DISA calls are handled when the destination does not answer the call within a preprogrammed time period.

### Default

Intercept

### Value Range

Disconnect, Intercept

### Programming Manual References

[507] DISA Intercept Mode

### Feature Manual References

1.1.41 Direct Inward System Access (DISA)

1.1.68 Intercept Routing

1.1.120 Voice Mail APT Integration

1.1.121 Voice Mail Inband (DTMF) Integration

## Mode—DISA No Dial Mode

Selects how DISA calls are handled when the PBX does not receive either DTMF (Dual Tone Multi-Frequency) signals or a fax (CNG) tone within a preprogrammed time period.

### Default

Intercept

### **Value Range**

Disconnect, Intercept

### **Programming Manual References**

[510] DISA No Dial Mode

### **Feature Manual References**

1.1.41 Direct Inward System Access (DISA)

1.1.68 Intercept Routing

## **Timers—DISA Delayed Answer Time**

Selects the length of time the caller hears a ringback tone before hearing a DISA OGM or a short beep.

### **Default**

3 s

### **Value Range**

0 s, 3 s, 6 s, 12 s

### **Programming Manual References**

[504] DISA Delayed Answer Time

### **Feature Manual References**

1.1.41 Direct Inward System Access (DISA)

## **Timers—DISA Wait Time after OGM**

Selects the length of time the PBX keeps detecting DTMF signals or a fax (CNG) tone after completing a DISA OGM.

### **Default**

5 s

### **Value Range**

0 s, 5 s, 10 s, 15 s

### **Programming Manual References**

[505] DISA Wait Time after OGM

### **Feature Manual References**

1.1.41 Direct Inward System Access (DISA)

## **Timers—DISA Ring Time before Intercept**

Selects the length of time until a DISA call is redirected to the intercept destination (Intercept Routing—No Answer feature).

**Default**

20 s

**Value Range**

10 s, 20 s, 30 s, 40 s, 60 s, 120 s

**Programming Manual References**

[508] DISA Ring Time before Intercept

**Feature Manual References**

1.1.41 Direct Inward System Access (DISA)

1.1.68 Intercept Routing

**Timers—DISA Ring Time after Intercept**

Selects the length of time to ring the destination extension when a DISA call is redirected to the intercept destination after the time specified in **Timers—DISA Ring Time before Intercept** on this screen expires. When the destination extension does not answer the call within the preprogrammed time period, the call is disconnected.

**Default**

20 s

**Value Range**

10 s, 20 s, 30 s, 40 s, 60 s, 120 s

**Programming Manual References**

[509] DISA Ring Time after Intercept

**Feature Manual References**

1.1.41 Direct Inward System Access (DISA)

1.1.68 Intercept Routing

**Timers—Intercept Time for Internal DISA**

Selects the length of time the PBX keeps detecting DTMF signals after receiving a call using DISA when no DISA OGM is recorded.

**Default**

3 s

**Value Range**

3 s, 6 s, 9 s

**Programming Manual References**

[515] Intercept Time for Internal DISA

### Feature Manual References

1.1.41 Direct Inward System Access (DISA)

## FAX & Tone—FAX Connection

Selects the extension number of the extension to receive fax data when the PBX receives a fax (CNG) tone via the DISA feature. The assigned extension will automatically have the Data Line Security feature set. The extension number and name are shown with the jack number.

### Default

Disable

### Value Range

Disable, Jack 01–24 (Extension no. and name specified in **Ext. no.** and **Name** on the **9.1.3 Numbering Plan [1-3]** screen)

### Programming Manual References

[503] FAX Connection

9.1.3 Numbering Plan [1-3]—Ext. no., Name

### Feature Manual References

1.1.41 Direct Inward System Access (DISA)

## FAX & Tone—FAX Tone Detection

Selects the number of times the fax (CNG) tone must be detected while the DISA OGM is sent before the PBX recognizes the incoming signal as fax data.

### Default

1 time

### Value Range

1 time, 2 times

### Programming Manual References

[514] FAX Tone Detection

### Feature Manual References

1.1.41 Direct Inward System Access (DISA)

## FAX & Tone—Cyclic Tone Detection

Selects the number of times the cyclic tone must be detected while the DISA OGM is sent so that the PBX can recognize the end of the DISA call.

### Default

4 times

**Value Range**

Disable, 2–4 times

**Programming Manual References**

[513] Cyclic Tone Detection

**Feature Manual References**

1.1.41 Direct Inward System Access (DISA)

**FAX & Tone—DISA Ringback Tone**

Selects whether to send a ringback tone or Music on Hold to the caller when a DISA call is received.

**Default**

Ringback Tone

**Value Range**

Ringback Tone, Music on Hold

**Programming Manual References**

[531] DISA Ringback Tone

**Feature Manual References**

1.1.41 Direct Inward System Access (DISA)

**9.6.4 Incoming Permission [6-3]**

The settings to receive Direct Inward System Access (DISA) calls can be programmed for each extension.

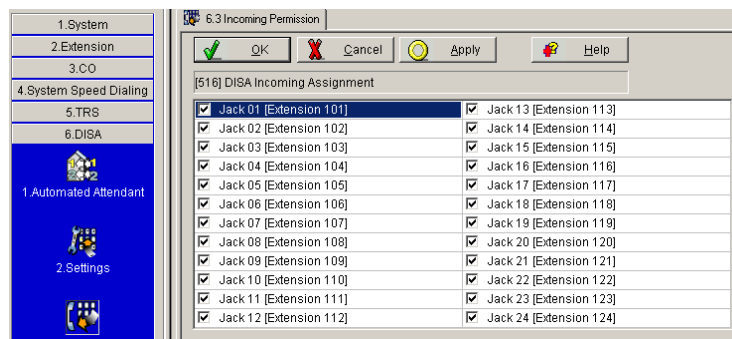
**Jack 01–24**

Enables receiving calls from DISA for each extension. The extension number and name specified in **Ext. no.** and **Name** on the **9.1.3 Numbering Plan [1-3]** screen are shown with the jack number.

**Default**

All jacks: On

**Value Range**

On (checked), Off (unchecked)

**Programming Manual References**

[516] DISA Incoming Assignment

9.1.3 Numbering Plan [1-3]—Ext. no., Name

**Feature Manual References**

1.1.41 Direct Inward System Access (DISA)

# 9.7 Doorphone [7]

## 9.7.1 Ringing & Door Opener [7-1]

Settings for receiving doorphone calls and accessing door openers can be programmed. A maximum of 4 doorphones/door openers can be connected to the PBX.

### Doorphone

The settings for receiving doorphone calls can be programmed for each extension.

Jack	Extension	Doorphone 1			Doorphone 2			Doorphone 3			Doorphone 4		
		Day	Night	Lunch	Day	Night	Lunch	Day	Night	Lunch	Day	Night	Lunch
01	101	<input checked="" type="checkbox"/>	<input checked="" type="checkbox"/>	<input checked="" type="checkbox"/>	<input checked="" type="checkbox"/>	<input checked="" type="checkbox"/>	<input checked="" type="checkbox"/>	<input checked="" type="checkbox"/>	<input checked="" type="checkbox"/>	<input checked="" type="checkbox"/>	<input checked="" type="checkbox"/>	<input checked="" type="checkbox"/>	<input checked="" type="checkbox"/>
02	102	<input checked="" type="checkbox"/>	<input checked="" type="checkbox"/>	<input checked="" type="checkbox"/>	<input checked="" type="checkbox"/>	<input checked="" type="checkbox"/>	<input checked="" type="checkbox"/>	<input checked="" type="checkbox"/>	<input checked="" type="checkbox"/>	<input checked="" type="checkbox"/>	<input checked="" type="checkbox"/>	<input checked="" type="checkbox"/>	<input checked="" type="checkbox"/>
03	103	<input checked="" type="checkbox"/>	<input checked="" type="checkbox"/>	<input checked="" type="checkbox"/>	<input checked="" type="checkbox"/>	<input checked="" type="checkbox"/>	<input checked="" type="checkbox"/>	<input checked="" type="checkbox"/>	<input checked="" type="checkbox"/>	<input checked="" type="checkbox"/>	<input checked="" type="checkbox"/>	<input checked="" type="checkbox"/>	<input checked="" type="checkbox"/>
04	104	<input checked="" type="checkbox"/>	<input checked="" type="checkbox"/>	<input checked="" type="checkbox"/>	<input checked="" type="checkbox"/>	<input checked="" type="checkbox"/>	<input checked="" type="checkbox"/>	<input checked="" type="checkbox"/>	<input checked="" type="checkbox"/>	<input checked="" type="checkbox"/>	<input checked="" type="checkbox"/>	<input checked="" type="checkbox"/>	<input checked="" type="checkbox"/>
05	105	<input checked="" type="checkbox"/>	<input checked="" type="checkbox"/>	<input checked="" type="checkbox"/>	<input checked="" type="checkbox"/>	<input checked="" type="checkbox"/>	<input checked="" type="checkbox"/>	<input checked="" type="checkbox"/>	<input checked="" type="checkbox"/>	<input checked="" type="checkbox"/>	<input checked="" type="checkbox"/>	<input checked="" type="checkbox"/>	<input checked="" type="checkbox"/>
06	106	<input checked="" type="checkbox"/>	<input checked="" type="checkbox"/>	<input checked="" type="checkbox"/>	<input checked="" type="checkbox"/>	<input checked="" type="checkbox"/>	<input checked="" type="checkbox"/>	<input checked="" type="checkbox"/>	<input checked="" type="checkbox"/>	<input checked="" type="checkbox"/>	<input checked="" type="checkbox"/>	<input checked="" type="checkbox"/>	<input checked="" type="checkbox"/>
07	107	<input checked="" type="checkbox"/>	<input checked="" type="checkbox"/>	<input checked="" type="checkbox"/>	<input checked="" type="checkbox"/>	<input checked="" type="checkbox"/>	<input checked="" type="checkbox"/>	<input checked="" type="checkbox"/>	<input checked="" type="checkbox"/>	<input checked="" type="checkbox"/>	<input checked="" type="checkbox"/>	<input checked="" type="checkbox"/>	<input checked="" type="checkbox"/>
08	108	<input checked="" type="checkbox"/>	<input checked="" type="checkbox"/>	<input checked="" type="checkbox"/>	<input checked="" type="checkbox"/>	<input checked="" type="checkbox"/>	<input checked="" type="checkbox"/>	<input checked="" type="checkbox"/>	<input checked="" type="checkbox"/>	<input checked="" type="checkbox"/>	<input checked="" type="checkbox"/>	<input checked="" type="checkbox"/>	<input checked="" type="checkbox"/>
09	109	<input checked="" type="checkbox"/>	<input checked="" type="checkbox"/>	<input checked="" type="checkbox"/>	<input checked="" type="checkbox"/>	<input checked="" type="checkbox"/>	<input checked="" type="checkbox"/>	<input checked="" type="checkbox"/>	<input checked="" type="checkbox"/>	<input checked="" type="checkbox"/>	<input checked="" type="checkbox"/>	<input checked="" type="checkbox"/>	<input checked="" type="checkbox"/>
10	110	<input checked="" type="checkbox"/>	<input checked="" type="checkbox"/>	<input checked="" type="checkbox"/>	<input checked="" type="checkbox"/>	<input checked="" type="checkbox"/>	<input checked="" type="checkbox"/>	<input checked="" type="checkbox"/>	<input checked="" type="checkbox"/>	<input checked="" type="checkbox"/>	<input checked="" type="checkbox"/>	<input checked="" type="checkbox"/>	<input checked="" type="checkbox"/>
11	111	<input checked="" type="checkbox"/>	<input checked="" type="checkbox"/>	<input checked="" type="checkbox"/>	<input checked="" type="checkbox"/>	<input checked="" type="checkbox"/>	<input checked="" type="checkbox"/>	<input checked="" type="checkbox"/>	<input checked="" type="checkbox"/>	<input checked="" type="checkbox"/>	<input checked="" type="checkbox"/>	<input checked="" type="checkbox"/>	<input checked="" type="checkbox"/>
12	112	<input checked="" type="checkbox"/>	<input checked="" type="checkbox"/>	<input checked="" type="checkbox"/>	<input checked="" type="checkbox"/>	<input checked="" type="checkbox"/>	<input checked="" type="checkbox"/>	<input checked="" type="checkbox"/>	<input checked="" type="checkbox"/>	<input checked="" type="checkbox"/>	<input checked="" type="checkbox"/>	<input checked="" type="checkbox"/>	<input checked="" type="checkbox"/>
13	113	<input checked="" type="checkbox"/>	<input checked="" type="checkbox"/>	<input checked="" type="checkbox"/>	<input checked="" type="checkbox"/>	<input checked="" type="checkbox"/>	<input checked="" type="checkbox"/>	<input checked="" type="checkbox"/>	<input checked="" type="checkbox"/>	<input checked="" type="checkbox"/>	<input checked="" type="checkbox"/>	<input checked="" type="checkbox"/>	<input checked="" type="checkbox"/>
14	114	<input checked="" type="checkbox"/>	<input checked="" type="checkbox"/>	<input checked="" type="checkbox"/>	<input checked="" type="checkbox"/>	<input checked="" type="checkbox"/>	<input checked="" type="checkbox"/>	<input checked="" type="checkbox"/>	<input checked="" type="checkbox"/>	<input checked="" type="checkbox"/>	<input checked="" type="checkbox"/>	<input checked="" type="checkbox"/>	<input checked="" type="checkbox"/>
15	115	<input checked="" type="checkbox"/>	<input checked="" type="checkbox"/>	<input checked="" type="checkbox"/>	<input checked="" type="checkbox"/>	<input checked="" type="checkbox"/>	<input checked="" type="checkbox"/>	<input checked="" type="checkbox"/>	<input checked="" type="checkbox"/>	<input checked="" type="checkbox"/>	<input checked="" type="checkbox"/>	<input checked="" type="checkbox"/>	<input checked="" type="checkbox"/>
16	116	<input checked="" type="checkbox"/>	<input checked="" type="checkbox"/>	<input checked="" type="checkbox"/>	<input checked="" type="checkbox"/>	<input checked="" type="checkbox"/>	<input checked="" type="checkbox"/>	<input checked="" type="checkbox"/>	<input checked="" type="checkbox"/>	<input checked="" type="checkbox"/>	<input checked="" type="checkbox"/>	<input checked="" type="checkbox"/>	<input checked="" type="checkbox"/>
17	117	<input checked="" type="checkbox"/>	<input checked="" type="checkbox"/>	<input checked="" type="checkbox"/>	<input checked="" type="checkbox"/>	<input checked="" type="checkbox"/>	<input checked="" type="checkbox"/>	<input checked="" type="checkbox"/>	<input checked="" type="checkbox"/>	<input checked="" type="checkbox"/>	<input checked="" type="checkbox"/>	<input checked="" type="checkbox"/>	<input checked="" type="checkbox"/>
18	118	<input checked="" type="checkbox"/>	<input checked="" type="checkbox"/>	<input checked="" type="checkbox"/>	<input checked="" type="checkbox"/>	<input checked="" type="checkbox"/>	<input checked="" type="checkbox"/>	<input checked="" type="checkbox"/>	<input checked="" type="checkbox"/>	<input checked="" type="checkbox"/>	<input checked="" type="checkbox"/>	<input checked="" type="checkbox"/>	<input checked="" type="checkbox"/>
19	119	<input checked="" type="checkbox"/>	<input checked="" type="checkbox"/>	<input checked="" type="checkbox"/>	<input checked="" type="checkbox"/>	<input checked="" type="checkbox"/>	<input checked="" type="checkbox"/>	<input checked="" type="checkbox"/>	<input checked="" type="checkbox"/>	<input checked="" type="checkbox"/>	<input checked="" type="checkbox"/>	<input checked="" type="checkbox"/>	<input checked="" type="checkbox"/>
20	120	<input checked="" type="checkbox"/>	<input checked="" type="checkbox"/>	<input checked="" type="checkbox"/>	<input checked="" type="checkbox"/>	<input checked="" type="checkbox"/>	<input checked="" type="checkbox"/>	<input checked="" type="checkbox"/>	<input checked="" type="checkbox"/>	<input checked="" type="checkbox"/>	<input checked="" type="checkbox"/>	<input checked="" type="checkbox"/>	<input checked="" type="checkbox"/>
21	121	<input checked="" type="checkbox"/>	<input checked="" type="checkbox"/>	<input checked="" type="checkbox"/>	<input checked="" type="checkbox"/>	<input checked="" type="checkbox"/>	<input checked="" type="checkbox"/>	<input checked="" type="checkbox"/>	<input checked="" type="checkbox"/>	<input checked="" type="checkbox"/>	<input checked="" type="checkbox"/>	<input checked="" type="checkbox"/>	<input checked="" type="checkbox"/>
22	122	<input checked="" type="checkbox"/>	<input checked="" type="checkbox"/>	<input checked="" type="checkbox"/>	<input checked="" type="checkbox"/>	<input checked="" type="checkbox"/>	<input checked="" type="checkbox"/>	<input checked="" type="checkbox"/>	<input checked="" type="checkbox"/>	<input checked="" type="checkbox"/>	<input checked="" type="checkbox"/>	<input checked="" type="checkbox"/>	<input checked="" type="checkbox"/>
23	123	<input checked="" type="checkbox"/>	<input checked="" type="checkbox"/>	<input checked="" type="checkbox"/>	<input checked="" type="checkbox"/>	<input checked="" type="checkbox"/>	<input checked="" type="checkbox"/>	<input checked="" type="checkbox"/>	<input checked="" type="checkbox"/>	<input checked="" type="checkbox"/>	<input checked="" type="checkbox"/>	<input checked="" type="checkbox"/>	<input checked="" type="checkbox"/>
24	124	<input checked="" type="checkbox"/>	<input checked="" type="checkbox"/>	<input checked="" type="checkbox"/>	<input checked="" type="checkbox"/>	<input checked="" type="checkbox"/>	<input checked="" type="checkbox"/>	<input checked="" type="checkbox"/>	<input checked="" type="checkbox"/>	<input checked="" type="checkbox"/>	<input checked="" type="checkbox"/>	<input checked="" type="checkbox"/>	<input checked="" type="checkbox"/>

**Jack**

Indicates the jack number (reference only).

**Value Range**

01–24

### Extension

Indicates the extension number and name (reference only).

### Value Range

Extension no. and name specified in **Ext. no.** and **Name** on the **9.1.3 Numbering Plan [1-3]** screen

### Programming Manual References

9.1.3 Numbering Plan [1-3]—Ext. no., Name

## Doorphone 1–4—Day, Night, Lunch

Enables doorphone call reception in each time service mode.

### Default

All doorphones—all jacks: On

### Value Range

On (checked), Off (unchecked)

### Programming Manual References

[700-702] Doorphone Ringing—Day/Night/Lunch

### Feature Manual References

1.1.48 Doorphone Call

## Door Opener

The settings for unlocking the door can be programmed for each extension.

Jack	Extension	Door Opener 1			Door Opener 2			Door Opener 3			Door Opener 4		
		Day	Night	Lunch	Day	Night	Lunch	Day	Night	Lunch	Day	Night	Lunch
01	101	<input checked="" type="checkbox"/>	<input checked="" type="checkbox"/>	<input checked="" type="checkbox"/>	<input checked="" type="checkbox"/>	<input checked="" type="checkbox"/>	<input checked="" type="checkbox"/>	<input checked="" type="checkbox"/>	<input checked="" type="checkbox"/>	<input checked="" type="checkbox"/>	<input checked="" type="checkbox"/>	<input checked="" type="checkbox"/>	<input checked="" type="checkbox"/>
02	102	<input checked="" type="checkbox"/>	<input checked="" type="checkbox"/>	<input checked="" type="checkbox"/>	<input checked="" type="checkbox"/>	<input checked="" type="checkbox"/>	<input checked="" type="checkbox"/>	<input checked="" type="checkbox"/>	<input checked="" type="checkbox"/>	<input checked="" type="checkbox"/>	<input checked="" type="checkbox"/>	<input checked="" type="checkbox"/>	<input checked="" type="checkbox"/>
03	103	<input checked="" type="checkbox"/>	<input checked="" type="checkbox"/>	<input checked="" type="checkbox"/>	<input checked="" type="checkbox"/>	<input checked="" type="checkbox"/>	<input checked="" type="checkbox"/>	<input checked="" type="checkbox"/>	<input checked="" type="checkbox"/>	<input checked="" type="checkbox"/>	<input checked="" type="checkbox"/>	<input checked="" type="checkbox"/>	<input checked="" type="checkbox"/>
04	104	<input checked="" type="checkbox"/>	<input checked="" type="checkbox"/>	<input checked="" type="checkbox"/>	<input checked="" type="checkbox"/>	<input checked="" type="checkbox"/>	<input checked="" type="checkbox"/>	<input checked="" type="checkbox"/>	<input checked="" type="checkbox"/>	<input checked="" type="checkbox"/>	<input checked="" type="checkbox"/>	<input checked="" type="checkbox"/>	<input checked="" type="checkbox"/>
05	105	<input checked="" type="checkbox"/>	<input checked="" type="checkbox"/>	<input checked="" type="checkbox"/>	<input checked="" type="checkbox"/>	<input checked="" type="checkbox"/>	<input checked="" type="checkbox"/>	<input checked="" type="checkbox"/>	<input checked="" type="checkbox"/>	<input checked="" type="checkbox"/>	<input checked="" type="checkbox"/>	<input checked="" type="checkbox"/>	<input checked="" type="checkbox"/>
06	106	<input checked="" type="checkbox"/>	<input checked="" type="checkbox"/>	<input checked="" type="checkbox"/>	<input checked="" type="checkbox"/>	<input checked="" type="checkbox"/>	<input checked="" type="checkbox"/>	<input checked="" type="checkbox"/>	<input checked="" type="checkbox"/>	<input checked="" type="checkbox"/>	<input checked="" type="checkbox"/>	<input checked="" type="checkbox"/>	<input checked="" type="checkbox"/>
07	107	<input checked="" type="checkbox"/>	<input checked="" type="checkbox"/>	<input checked="" type="checkbox"/>	<input checked="" type="checkbox"/>	<input checked="" type="checkbox"/>	<input checked="" type="checkbox"/>	<input checked="" type="checkbox"/>	<input checked="" type="checkbox"/>	<input checked="" type="checkbox"/>	<input checked="" type="checkbox"/>	<input checked="" type="checkbox"/>	<input checked="" type="checkbox"/>
08	108	<input checked="" type="checkbox"/>	<input checked="" type="checkbox"/>	<input checked="" type="checkbox"/>	<input checked="" type="checkbox"/>	<input checked="" type="checkbox"/>	<input checked="" type="checkbox"/>	<input checked="" type="checkbox"/>	<input checked="" type="checkbox"/>	<input checked="" type="checkbox"/>	<input checked="" type="checkbox"/>	<input checked="" type="checkbox"/>	<input checked="" type="checkbox"/>
09	109	<input checked="" type="checkbox"/>	<input checked="" type="checkbox"/>	<input checked="" type="checkbox"/>	<input checked="" type="checkbox"/>	<input checked="" type="checkbox"/>	<input checked="" type="checkbox"/>	<input checked="" type="checkbox"/>	<input checked="" type="checkbox"/>	<input checked="" type="checkbox"/>	<input checked="" type="checkbox"/>	<input checked="" type="checkbox"/>	<input checked="" type="checkbox"/>
10	110	<input checked="" type="checkbox"/>	<input checked="" type="checkbox"/>	<input checked="" type="checkbox"/>	<input checked="" type="checkbox"/>	<input checked="" type="checkbox"/>	<input checked="" type="checkbox"/>	<input checked="" type="checkbox"/>	<input checked="" type="checkbox"/>	<input checked="" type="checkbox"/>	<input checked="" type="checkbox"/>	<input checked="" type="checkbox"/>	<input checked="" type="checkbox"/>
11	111	<input checked="" type="checkbox"/>	<input checked="" type="checkbox"/>	<input checked="" type="checkbox"/>	<input checked="" type="checkbox"/>	<input checked="" type="checkbox"/>	<input checked="" type="checkbox"/>	<input checked="" type="checkbox"/>	<input checked="" type="checkbox"/>	<input checked="" type="checkbox"/>	<input checked="" type="checkbox"/>	<input checked="" type="checkbox"/>	<input checked="" type="checkbox"/>
12	112	<input checked="" type="checkbox"/>	<input checked="" type="checkbox"/>	<input checked="" type="checkbox"/>	<input checked="" type="checkbox"/>	<input checked="" type="checkbox"/>	<input checked="" type="checkbox"/>	<input checked="" type="checkbox"/>	<input checked="" type="checkbox"/>	<input checked="" type="checkbox"/>	<input checked="" type="checkbox"/>	<input checked="" type="checkbox"/>	<input checked="" type="checkbox"/>
13	113	<input checked="" type="checkbox"/>	<input checked="" type="checkbox"/>	<input checked="" type="checkbox"/>	<input checked="" type="checkbox"/>	<input checked="" type="checkbox"/>	<input checked="" type="checkbox"/>	<input checked="" type="checkbox"/>	<input checked="" type="checkbox"/>	<input checked="" type="checkbox"/>	<input checked="" type="checkbox"/>	<input checked="" type="checkbox"/>	<input checked="" type="checkbox"/>
14	114	<input checked="" type="checkbox"/>	<input checked="" type="checkbox"/>	<input checked="" type="checkbox"/>	<input checked="" type="checkbox"/>	<input checked="" type="checkbox"/>	<input checked="" type="checkbox"/>	<input checked="" type="checkbox"/>	<input checked="" type="checkbox"/>	<input checked="" type="checkbox"/>	<input checked="" type="checkbox"/>	<input checked="" type="checkbox"/>	<input checked="" type="checkbox"/>
15	115	<input checked="" type="checkbox"/>	<input checked="" type="checkbox"/>	<input checked="" type="checkbox"/>	<input checked="" type="checkbox"/>	<input checked="" type="checkbox"/>	<input checked="" type="checkbox"/>	<input checked="" type="checkbox"/>	<input checked="" type="checkbox"/>	<input checked="" type="checkbox"/>	<input checked="" type="checkbox"/>	<input checked="" type="checkbox"/>	<input checked="" type="checkbox"/>
16	116	<input checked="" type="checkbox"/>	<input checked="" type="checkbox"/>	<input checked="" type="checkbox"/>	<input checked="" type="checkbox"/>	<input checked="" type="checkbox"/>	<input checked="" type="checkbox"/>	<input checked="" type="checkbox"/>	<input checked="" type="checkbox"/>	<input checked="" type="checkbox"/>	<input checked="" type="checkbox"/>	<input checked="" type="checkbox"/>	<input checked="" type="checkbox"/>
17	117	<input checked="" type="checkbox"/>	<input checked="" type="checkbox"/>	<input checked="" type="checkbox"/>	<input checked="" type="checkbox"/>	<input checked="" type="checkbox"/>	<input checked="" type="checkbox"/>	<input checked="" type="checkbox"/>	<input checked="" type="checkbox"/>	<input checked="" type="checkbox"/>	<input checked="" type="checkbox"/>	<input checked="" type="checkbox"/>	<input checked="" type="checkbox"/>
18	118	<input checked="" type="checkbox"/>	<input checked="" type="checkbox"/>	<input checked="" type="checkbox"/>	<input checked="" type="checkbox"/>	<input checked="" type="checkbox"/>	<input checked="" type="checkbox"/>	<input checked="" type="checkbox"/>	<input checked="" type="checkbox"/>	<input checked="" type="checkbox"/>	<input checked="" type="checkbox"/>	<input checked="" type="checkbox"/>	<input checked="" type="checkbox"/>
19	119	<input checked="" type="checkbox"/>	<input checked="" type="checkbox"/>	<input checked="" type="checkbox"/>	<input checked="" type="checkbox"/>	<input checked="" type="checkbox"/>	<input checked="" type="checkbox"/>	<input checked="" type="checkbox"/>	<input checked="" type="checkbox"/>	<input checked="" type="checkbox"/>	<input checked="" type="checkbox"/>	<input checked="" type="checkbox"/>	<input checked="" type="checkbox"/>
20	120	<input checked="" type="checkbox"/>	<input checked="" type="checkbox"/>	<input checked="" type="checkbox"/>	<input checked="" type="checkbox"/>	<input checked="" type="checkbox"/>	<input checked="" type="checkbox"/>	<input checked="" type="checkbox"/>	<input checked="" type="checkbox"/>	<input checked="" type="checkbox"/>	<input checked="" type="checkbox"/>	<input checked="" type="checkbox"/>	<input checked="" type="checkbox"/>
21	121	<input checked="" type="checkbox"/>	<input checked="" type="checkbox"/>	<input checked="" type="checkbox"/>	<input checked="" type="checkbox"/>	<input checked="" type="checkbox"/>	<input checked="" type="checkbox"/>	<input checked="" type="checkbox"/>	<input checked="" type="checkbox"/>	<input checked="" type="checkbox"/>	<input checked="" type="checkbox"/>	<input checked="" type="checkbox"/>	<input checked="" type="checkbox"/>
22	122	<input checked="" type="checkbox"/>	<input checked="" type="checkbox"/>	<input checked="" type="checkbox"/>	<input checked="" type="checkbox"/>	<input checked="" type="checkbox"/>	<input checked="" type="checkbox"/>	<input checked="" type="checkbox"/>	<input checked="" type="checkbox"/>	<input checked="" type="checkbox"/>	<input checked="" type="checkbox"/>	<input checked="" type="checkbox"/>	<input checked="" type="checkbox"/>
23	123	<input checked="" type="checkbox"/>	<input checked="" type="checkbox"/>	<input checked="" type="checkbox"/>	<input checked="" type="checkbox"/>	<input checked="" type="checkbox"/>	<input checked="" type="checkbox"/>	<input checked="" type="checkbox"/>	<input checked="" type="checkbox"/>	<input checked="" type="checkbox"/>	<input checked="" type="checkbox"/>	<input checked="" type="checkbox"/>	<input checked="" type="checkbox"/>
24	124	<input checked="" type="checkbox"/>	<input checked="" type="checkbox"/>	<input checked="" type="checkbox"/>	<input checked="" type="checkbox"/>	<input checked="" type="checkbox"/>	<input checked="" type="checkbox"/>	<input checked="" type="checkbox"/>	<input checked="" type="checkbox"/>	<input checked="" type="checkbox"/>	<input checked="" type="checkbox"/>	<input checked="" type="checkbox"/>	<input checked="" type="checkbox"/>

## Jack

Indicates the jack number (reference only).

## Value Range

01–24

## Extension

Indicates the extension number and name (reference only).

## Value Range

Extension no. and name specified in **Ext. no.** and **Name** on the **9.1.3 Numbering Plan [1-3]** screen

## Programming Manual References

9.1.3 Numbering Plan [1-3]—Ext. no., Name

## Door Opener 1–4—Day, Night, Lunch

Enables door opening in each time service mode.

## Default

All door openers—all jacks: On

## Value Range

On (checked), Off (unchecked)

## Programming Manual References

[703-705] Door Opener—Day/Night/Lunch

## Feature Manual References

1.1.46 Door Open

## 9.7.2 Others [7-2]

Other settings can be programmed for each doorphone. A maximum of 4 doorbell/door chimes can be connected to the PBX. Each doorphone can have one doorbell/door chime assigned to it.

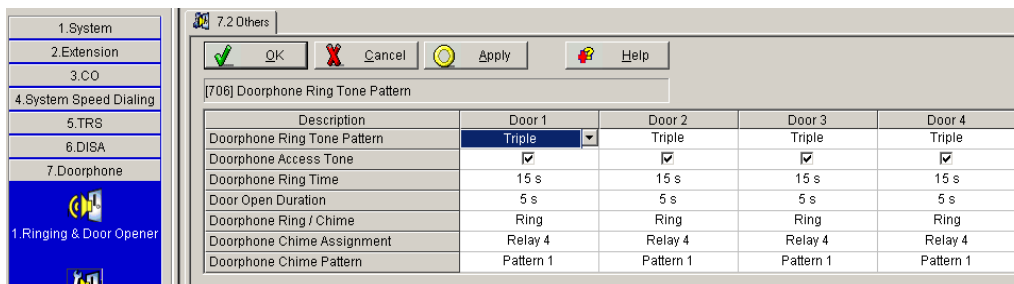

## Doorphone Ring Tone Pattern—Door 1–4

Selects the ring tone pattern for incoming doorphone calls.

### Default

All doors: Triple

### Value Range

Single, Double, Triple, S-Double

### Programming Manual References

[706] Doorphone Ring Tone Pattern

### Feature Manual References

1.1.48 Doorphone Call

1.1.108 Ring Tone Pattern Selection

## Doorphone Access Tone—Door 1–4

Selects whether the PBX sends a doorphone access tone to a monitored doorphone before monitoring starts.

### Default

All doors: On

### Value Range

On (checked), Off (unchecked)

### Programming Manual References

[707] Doorphone Access Tone

### Feature Manual References

1.1.48 Doorphone Call

1.1.110 Room Monitor

## Doorphone Ring Time—Door 1–4

Selects the length of time until the ringing stops and the call is canceled when there is no answer.

### Default

All doors: 15 s

### Value Range

15 s, 30 s

### Programming Manual References

[708] Doorphone Ring Time

### Feature Manual References

1.1.48 Doorphone Call

## Door Open Duration—Door 1–4

Specifies the length of time the door stays unlocked.

### Default

All doors: 5 s

### Value Range

1–8 s

### Programming Manual References

[709] Door Open Duration

### Feature Manual References

1.1.46 Door Open

## Doorphone Ring / Chime—Door 1–4

Selects whether doorphone calls ring at extensions or at dedicated door chimes.

### Default

All doors: Ring

### Value Range

Ring, Chime, Ring & Chime

### Programming Manual References

[710] Doorphone Ring/Chime

### Feature Manual References

1.1.47 Doorbell/Door Chime

1.1.48 Doorphone Call

## Doorphone Chime Assignment—Door 1–4

Selects the relay to which a doorbell or a door chime is connected.

A relay not connected to a door opener should be selected. This setting is active only when **Chime** or **Ring & Chime** is selected in **Doorphone Ring / Chime—Door 1–4** on this screen.

### Default

All doors: Relay 4

### Value Range

Relay 1–4

**Programming Manual References**

[711] Doorphone Chime Assignment

**Feature Manual References**

1.1.47 Doorbell/Door Chime

1.1.48 Doorphone Call

**Doorphone Chime Pattern—Door 1–4**

Selects the doorphone chime pattern for incoming doorphone calls. Chime patterns 1–4 are played only one time during the doorphone ringing time.

**Default**

All doors: Pattern 1

**Value Range**

Pattern 1–8

**Programming Manual References**

[712] Doorphone Chime Pattern

**Feature Manual References**

1.1.47 Doorbell/Door Chime

1.1.48 Doorphone Call

2.2.1 Tones/Ring Tones

## 9.8 BV [8]

### 9.8.1 Main [8-1]

Built-in Voice Message (BV) allows a caller to leave a voice message in one of the voice message areas, and information on the recorded message is automatically logged in the Incoming Call Log of the extension, where it can be viewed later or used to play back the original message.

Jack	Extension	BV for Extension	BV Resource	BV Access Code
01	101	<input checked="" type="checkbox"/>	BV 1	#101
02	102	<input checked="" type="checkbox"/>	BV 1	#102
03	103	<input checked="" type="checkbox"/>	BV 2	#103
04	104	<input checked="" type="checkbox"/>	BV 2	#104
05	105	<input checked="" type="checkbox"/>	BV 2	#105
06	106	<input checked="" type="checkbox"/>	BV 2	#106
07	107	<input checked="" type="checkbox"/>	BV 2	#107
08	108	<input checked="" type="checkbox"/>	BV 2	#108
09	109	<input checked="" type="checkbox"/>	BV 2	#109
10	110	<input checked="" type="checkbox"/>	BV 2	#110
11	111	<input checked="" type="checkbox"/>	BV 2	#111
12	112	<input checked="" type="checkbox"/>	BV 2	#112
13	113	<input checked="" type="checkbox"/>	BV 2	#113
14	114	<input checked="" type="checkbox"/>	BV 2	#114
15	115	<input checked="" type="checkbox"/>	BV 2	#115
16	116	<input checked="" type="checkbox"/>	BV 2	#116
17	117	<input checked="" type="checkbox"/>	BV 2	#117
18	118	<input checked="" type="checkbox"/>	BV 2	#118
19	119	<input checked="" type="checkbox"/>	BV 2	#119
20	120	<input checked="" type="checkbox"/>	BV 2	#120
21	121	<input checked="" type="checkbox"/>	BV 2	#121
22	122	<input checked="" type="checkbox"/>	BV 2	#122
23	123	<input checked="" type="checkbox"/>	BV 2	#123
24	124	<input checked="" type="checkbox"/>	BV 2	#124

#### Jack

Indicates the jack number (reference only).

#### Value Range

01–24

#### Extension

Indicates the extension number and name (reference only).

#### Value Range

Extension no. and name specified in **Ext. no.** and **Name** on the **9.1.3 Numbering Plan [1-3]** screen

#### Programming Manual References

9.1.3 Numbering Plan [1-3]—Ext. no., Name

## BV for Extension

Enables the BV feature for each extension.

### Default

All jacks: On

### Value Range

On (checked), Off (unchecked)

### Programming Manual References

[622] BV for Extension

### Feature Manual References

1.1.8 Built-in Voice Message (BV)

## BV Resource

Selects the BV resource to which the extension belongs.

### Default

Jack 01–02: BV 1, Jack 03–24: BV 2

### Value Range

BV 1, BV 2

### Programming Manual References

[621] BV Resource

### Feature Manual References

1.1.8 Built-in Voice Message (BV)

## BV Access Code

Specifies a voice message access code used to play back and/or erase voice messages through outside (CO) lines. The voice message access code should be different from the corresponding extension number. If the voice message access code is the same as an extension number, dialing that number will access the extension, not the voice message area. A code that starts with a number already assigned as another code cannot be used. For example, if you assign the codes "1234" and "12345", "12345" cannot be selected since "1234" will be recognized first.

### Default

Jack 01–24 = #101–#124 (e.g., Jack 01: #101, Jack 02: #102)

### Value Range

4–10 digits (consisting of 0–9 and #)

### Programming Manual References

[625] BV Access Code through CO Line

## Feature Manual References

### 1.1.8 Built-in Voice Message (BV)

## 9.8.2 Others [8-2]

Various settings for Built-in Voice Message (BV) can be programmed.

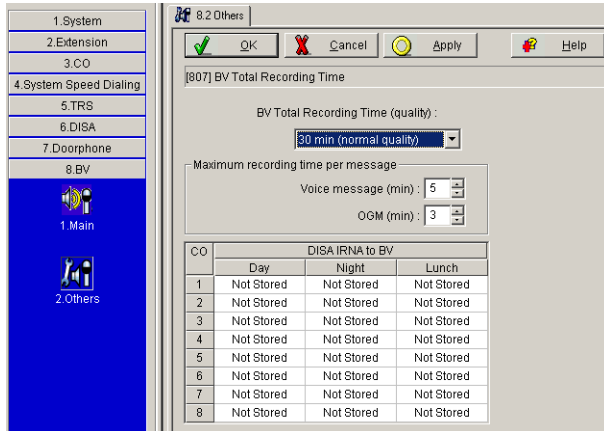

### BV Total Recording Time (quality)

Selects the total recording time for each BV resource.

#### Default

30 min (normal quality)

#### Value Range

20 min (high quality), 30 min (normal quality), 60 min (low quality)

### Programming Manual References

[807] BV Total Recording Time

### Feature Manual References

1.1.8 Built-in Voice Message (BV)

### Maximum recording time per message—Voice message

Selects the maximum recording time for each voice message.

#### Default

5 min

#### Value Range

1–20 min

### Programming Manual References

[214] BV Recording Time

**Feature Manual References**

1.1.8 Built-in Voice Message (BV)

**Maximum recording time per message—OGM**

Selects the maximum recording time for each personal/common BV outgoing message (OGM).

**Default**

3 min

**Value Range**

1–15 min

**Programming Manual References**

[215] Common/Personal BV OGM Recording Time

**Feature Manual References**

1.1.8 Built-in Voice Message (BV)

**CO**

Indicates the outside (CO) line port number (reference only).

**Value Range**

1–8

**DISA IRNA to BV—Day, Night, Lunch**

Selects the common BV OGM used as the intercept destination of unanswered Direct Inward System Access (DISA) calls in each time service mode.

**Default**

All outside (CO) lines: Not Stored

**Value Range**

Not Stored, BV 01–24

**Programming Manual References**

[438-440] DISA IRNA to BV—Day/Night/Lunch

**Feature Manual References**

1.1.8 Built-in Voice Message (BV)

## 9.9 Caller ID [9]

### 9.9.1 Main [9-1]

The settings of the Caller ID feature can be programmed.

CO	Caller ID	Call Waiting Caller ID
1	<input checked="" type="checkbox"/>	<input checked="" type="checkbox"/>
2	<input checked="" type="checkbox"/>	<input checked="" type="checkbox"/>
3	<input checked="" type="checkbox"/>	<input checked="" type="checkbox"/>
4	<input checked="" type="checkbox"/>	<input checked="" type="checkbox"/>
5	<input checked="" type="checkbox"/>	<input checked="" type="checkbox"/>
6	<input checked="" type="checkbox"/>	<input checked="" type="checkbox"/>
7	<input checked="" type="checkbox"/>	<input checked="" type="checkbox"/>
8	<input checked="" type="checkbox"/>	<input checked="" type="checkbox"/>

Local calls			
No.	Local Area Code	Removed Digits	Added Number
1		3 digits	
2		3 digits	
3		3 digits	
4		3 digits	
5		3 digits	

Long distance calls	
Removed Digits	Added Number
0 digit	1

Caller ID SMDR Format	With CID
Caller ID SMDR Printout	<input type="checkbox"/>
Call Waiting Caller ID Time	30 s
Call Waiting Caller ID CAS Receive Time	72-96 ms
Caller ID Checksum	<input checked="" type="checkbox"/>

#### CO Line Settings—CO

Indicates the outside (CO) line port number (reference only).

#### Value Range

1–8

#### CO Line Settings—Caller ID

Enables the Caller ID feature for each outside (CO) line that has contracted the Caller ID Service from the telephone company. The Delayed Answer Time for the outside (CO) lines enabled here will always be 6 seconds even if 0 s or 3 s is selected in **Timers—DISA Delayed Answer Time** on the **9.6.3 Settings [6-2]** screen.

#### Default

All outside (CO) lines: On

#### Value Range

On (checked), Off (unchecked)

#### Programming Manual References

[900] Caller ID

9.6.3 Settings [6-2]—Timers—DISA Delayed Answer Time

## Feature Manual References

1.1.30 Caller ID

## CO Line Settings—Call Waiting Caller ID

Enables the Call Waiting Caller ID feature for each outside (CO) line that has had Caller ID Service contracted from the telephone company. When the Caller ID feature is disabled in **CO Line Settings—Caller ID** on this screen, the Call Waiting Caller ID feature does not function even if it is enabled here.

### Default

All outside (CO) lines: On

### Value Range

On (checked), Off (unchecked)

## Programming Manual References

[913] Call Waiting Caller ID Assignment

## Feature Manual References

1.1.28 Call Waiting Caller ID

## Caller ID Modification—Local Area Code (for Local Call 1–5)

Specifies the leading number (area code) that will identify an incoming call as a local call.

### Default

All local calls: — (Not stored)

### Value Range

Max. 6 digits (consisting of 0–9)

## Programming Manual References

[901] Caller ID Area Code

## Feature Manual References

1.1.18 Call Log, Incoming

1.1.30 Caller ID

## Caller ID Modification—Removed Digits

Selects the number of digits to be removed from the beginning of the incoming caller's number.

### Default

All local calls: 3 digits, Long distance calls: 0 digit

### Value Range

0–9 digits

### **Programming Manual References**

[902] Caller ID Modification for Local Calls

[903] Caller ID Modification for Long-distance Calls

### **Feature Manual References**

1.1.18 Call Log, Incoming

1.1.30 Caller ID

## **Caller ID Modification—Added Number**

Specifies the number to be added to the incoming caller's number in the place of the removed digits.

### **Default**

All local calls: — (Not stored), Long distance calls: 1

### **Value Range**

Max. 4 digits (consisting of 0–9, \*, and #)

### **Programming Manual References**

[902] Caller ID Modification for Local Calls

[903] Caller ID Modification for Long-distance Calls

### **Feature Manual References**

1.1.18 Call Log, Incoming

1.1.30 Caller ID

## **Caller ID SMDR Format**

Selects whether a caller's telephone number is printed out on SMDR or not. Even if a name is also sent by the Caller ID service, only the number is printed.

### **Default**

With CID

### **Value Range**

Without CID (CID: Caller ID), With CID (CID: Caller ID)

### **Programming Manual References**

[906] Caller ID SMDR Format

### **Feature Manual References**

1.1.30 Caller ID

1.1.112 Station Message Detail Recording (SMDR)

## **Caller ID SMDR Printout**

Enables the PBX to display a caller's telephone number on SMDR before the call is answered.

**Default**

Off

**Value Range**

On (checked), Off (unchecked)

**Programming Manual References**

[907] Caller ID SMDR Printout

**Feature Manual References**

1.1.30 Caller ID

1.1.112 Station Message Detail Recording (SMDR)

**Call Waiting Caller ID Time**

Selects the length of time that the Call Waiting Caller ID feature sent from the telephone company is shown on the display of the proprietary telephone (PT). The TRANSFER button, HOLD button, and CONF button do not function during the assigned time.

**Default**

30 s

**Value Range**

10 s, 20 s, 30 s, 40 s, 60 s, 120 s

**Programming Manual References**

[908] Call Waiting Caller ID Time

**Feature Manual References**

1.1.28 Call Waiting Caller ID

**Call Waiting Caller ID CAS Receive Time**

*This program is available when the Caller ID and Call Waiting Caller ID features are enabled in **CO Line Settings—Caller ID** and **CO Line Settings—Call Waiting Caller ID** respectively on this screen.*

If the extension user has a Call Waiting Caller ID during a conversation, the telephone company will send an alert tone (CAS) to the PBX. If the CAS duration is too long or too short, the CAS is ignored by the PBX. If the CAS is accepted, then the PBX will respond and the Call Waiting Caller ID feature will be performed. This program assigns the allowable CAS duration. Normally, it should not be necessary to change the default setting.

**Default**

72–96 ms

**Value Range**

40–120 ms, 64–96 ms, 72–96 ms

**Programming Manual References**

[914] Call Waiting Caller ID CAS Receive Time

**Feature Manual References**

1.1.28 Call Waiting Caller ID

**Caller ID Checksum**

Enables or disables the selection of the checksum mode. Normally, it should not be necessary to change the default setting.

**Default**

On

**Value Range**

On (checked), Off (unchecked)

**Programming Manual References**

[915] Caller ID Checksum

**Feature Manual References**

1.1.28 Call Waiting Caller ID

1.1.30 Caller ID

**9.9.2 SLT Caller ID [9-2]**

Various settings for single line telephone (SLT) Caller ID can be programmed.

The screenshot shows a software interface for configuring SLT Caller ID. On the left is a navigation menu with options: 1. System, 2. Extension, 3. CO, 4. System Speed Dialing, 5. TRS, 6. DISA, 7. Doorphone, 8. BV, 9. Caller ID (selected), 1. Main, 2. SLT Caller ID, and 3. Call Log. The main window is titled '9.2 SLT Caller ID' and contains a table with columns: Jack, Extension, SLT Caller ID, Ring Wait Time for New Call, and Fixed Bell Pattern. The table lists 24 rows of data, all with '0 s' for Ring Wait Time and 'Disable' for Fixed Bell Pattern. The 'SLT Caller ID' column contains checkboxes, all of which are currently unchecked. To the left of the table are configuration options: 'Ring / Silence Ratio' (set to 1:3), 'Bell-on Time (ms)' (set to 1300), 'SLT Caller ID Type' (set to 'FSK (During Ring)'), and a checked checkbox for 'Line Access Number'. Buttons for 'OK', 'Cancel', 'Apply', and 'Help' are at the top of the window.

Jack	Extension	SLT Caller ID	Ring Wait Time for New Call	Fixed Bell Pattern
01	101	<input type="checkbox"/>	0 s	Disable
02	102	<input type="checkbox"/>	0 s	Disable
03	103	<input type="checkbox"/>	0 s	Disable
04	104	<input type="checkbox"/>	0 s	Disable
05	105	<input type="checkbox"/>	0 s	Disable
06	106	<input type="checkbox"/>	0 s	Disable
07	107	<input type="checkbox"/>	0 s	Disable
08	108	<input type="checkbox"/>	0 s	Disable
09	109	<input type="checkbox"/>	0 s	Disable
10	110	<input type="checkbox"/>	0 s	Disable
11	111	<input type="checkbox"/>	0 s	Disable
12	112	<input type="checkbox"/>	0 s	Disable
13	113	<input type="checkbox"/>	0 s	Disable
14	114	<input type="checkbox"/>	0 s	Disable
15	115	<input type="checkbox"/>	0 s	Disable
16	116	<input type="checkbox"/>	0 s	Disable
17	117	<input type="checkbox"/>	0 s	Disable
18	118	<input type="checkbox"/>	0 s	Disable
19	119	<input type="checkbox"/>	0 s	Disable
20	120	<input type="checkbox"/>	0 s	Disable
21	121	<input type="checkbox"/>	0 s	Disable
22	122	<input type="checkbox"/>	0 s	Disable
23	123	<input type="checkbox"/>	0 s	Disable
24	124	<input type="checkbox"/>	0 s	Disable

## SLT Ring—Ring / Silence Ratio

Selects the ratio between the bell signals of an SLT (a set of bell-on and bell-off).

### Default

1:3

### Value Range

1:2, 1:3, 1:4

### Programming Manual References

[142] SLT Ring/Silence Ratio

### Feature Manual References

1.1.108 Ring Tone Pattern Selection

## SLT Ring—Bell-on Time

Selects the length of the bell-on signal of an SLT. When combined with the ratio selected in the **SLT Ring—Ring / Silence Ratio** list, this determines the ring tone pattern for incoming calls to SLTs. When **DTMF** is selected in the **SLT Caller ID—Type** list, this also determines the maximum number of digits of an SLT Caller ID number.

### Default

1300 ms

### Value Range

1000–2000 ms in 100 ms increments

### Programming Manual References

[143] SLT Ring Bell-on Time

### Feature Manual References

1.1.30 Caller ID

1.1.108 Ring Tone Pattern Selection

## SLT Caller ID—Type

Selects the signaling type of SLT Caller ID.

### Default

FSK (During Ring)

### Value Range

FSK (During Ring), FSK (RP-AS), DTMF (Immediate), DTMF (During Ring)

### Programming Manual References

[150] SLT Caller ID Signaling Type

### Feature Manual References

1.1.30 Caller ID

## SLT Caller ID—Line Access Number

Enables the PBX to automatically add an Outside (CO) Line Access number to the received telephone number when sending the Caller ID number of an incoming outside (CO) line call to an SLT.

### Default

On

### Value Range

On (checked), Off (unchecked)

### Programming Manual References

[151] SLT Caller ID Line Access Number

### Feature Manual References

1.1.30 Caller ID

## Jack

Indicates the jack number (reference only).

### Value Range

01–24

## Extension

Indicates the extension number and name (reference only).

### Value Range

Extension no. and name specified in **Ext. no.** and **Name** on the **9.1.3 Numbering Plan [1-3]** screen

### Programming Manual References

9.1.3 Numbering Plan [1-3]—Ext. no., Name

## SLT Caller ID

Enables the PBX to send Caller ID information to an SLT.

### Default

All jacks: Off

### Value Range

On (checked), Off (unchecked)

## Programming Manual References

[628] SLT Caller ID

## Feature Manual References

1.1.30 Caller ID

## Ring Wait Time for New Call

Selects the length of time the ringing for a call is delayed when the call follows immediately after the previous unanswered call. When receiving 2 calls in quick succession, for example, when a call waiting in a queue is directed to an extension immediately after the previous call stops ringing, some SLTs require a pause, after the first call stops ringing, to receive the second call's Caller ID information.

### Default

All jacks: 0 s

### Value Range

0–15 s

## Programming Manual References

[627] SLT Ring Wait Time for New Call

## Feature Manual References

1.1.30 Caller ID

## Fixed Bell Pattern

Selects the fixed ring tone pattern of the SLT for incoming calls (intercom calls and outside (CO) line calls). The same pattern as used by your telephone company may be selected.

### Default

All jacks: Disable

### Value Range

Disable, Single, Double

## Programming Manual References

[629] SLT Fixed Bell Pattern

## Feature Manual References

1.1.30 Caller ID

1.1.108 Ring Tone Pattern Selection

## 9.9.3 Call Log [9-3]

When a call containing Caller ID information is received by an extension, the information is shown on the telephone display and also automatically logged in the Incoming Call Log of the extension.

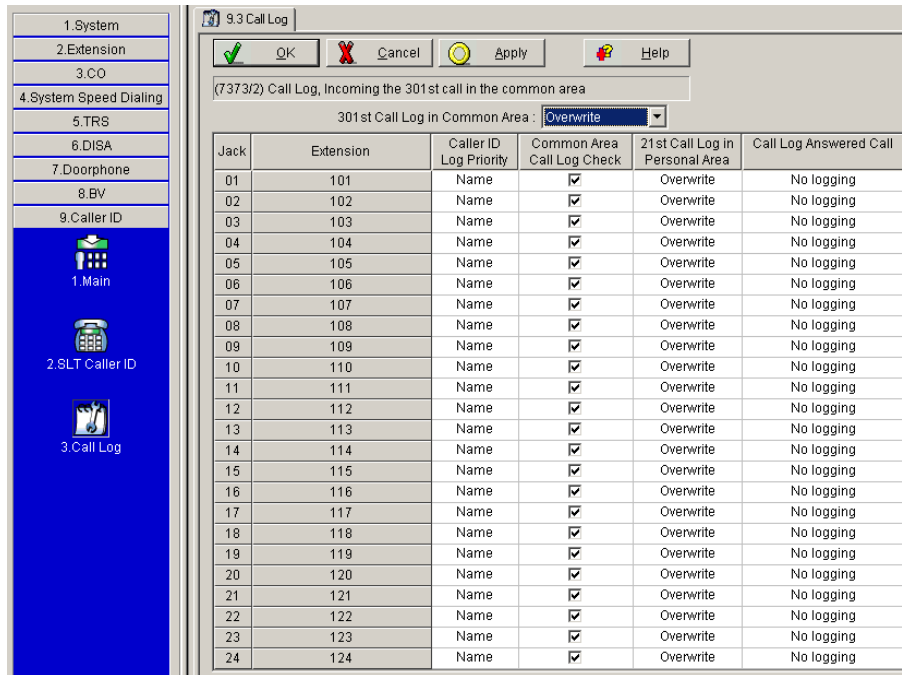

### 301st Call Log in Common Area

Selects whether the oldest call information in the common area will be replaced each time a call is received, or whether the new call information will be discarded when the call log is full (300 calls are stored) and a new call arrives.

#### Default

Overwrite

#### Value Range

Disregard, Overwrite

#### Feature Manual References

1.1.18 Call Log, Incoming

#### Operating Manual References

2.1.8 The 301st Call Log, Incoming in the Common Area Treatment

#### Jack

Indicates the jack number (reference only).

#### Value Range

01–24

## Extension

Indicates the extension number and name (reference only).

### Value Range

Extension no. and name specified in **Ext. no.** and **Name** on the **9.1.3 Numbering Plan [1-3]** screen

### Programming Manual References

9.1.3 Numbering Plan [1-3]—Ext. no., Name

## Caller ID Log Priority

Selects which caller information is shown first on the display of the proprietary telephone (PT). *This is available when the Caller ID service provides both a name and a number.*

### Default

All jacks: Name

### Value Range

Number, Name

### Programming Manual References

[904] Caller ID Log Priority

### Feature Manual References

1.1.18 Call Log, Incoming

1.1.30 Caller ID

1.1.43 Display Information

## Common Area Call Log Check

Specifies whether an extension can view call logs stored in the common area. If this program is enabled, the Caller ID Indication—Common button and Caller ID Selection—Common button can be assigned.

### Default

All jacks: On

### Value Range

On (checked), Off (unchecked)

### Programming Manual References

[909] Common Area Call Log Check

### Feature Manual References

1.1.18 Call Log, Incoming

## 21st Call Log in Personal Area

Selects whether the oldest call information in the personal area will be replaced each time a call is received, or whether the new call information will be discarded when a call log is full (20 calls are stored) and a new call arrives.

### Default

All jacks: Overwrite

### Value Range

Disregard, Overwrite

### Feature Manual References

1.1.18 Call Log, Incoming

### Operating Manual References

1.3.18 Call Log, Incoming

## Call Log Answered Call

Selects how Caller ID information is logged when answering calls.

### Default

All jacks: No logging

### Value Range

No logging, Personal Area, Common Area, Both

### Feature Manual References

1.1.18 Call Log, Incoming

### Operating Manual References

1.3.18 Call Log, Incoming

---

# ***Index***

## Numerics

3-level AA Assignment [540] 55

### A

Access Levels 85  
 Account Code [310] 36  
 Account Code Mode [605] 57  
 Account Codes [1-5] 128  
 Automated Attendant [6-1] 198  
 Automated Attendant [6-1] AA dial 200  
 Automatic Designated Line Access [419] 44  
 Automatic Pause Insertion Code [311] 37  
 Automatic Pause Insertion Codes [1-9] 139  
 Automatic Time Adjustment [152] 31

### B

BGM Control for APT [626] 63  
 BV [8] 214  
 BV Access Code through CO Line [625] 63  
 BV Card Initialization 118  
 BV Card Initialization [808] 72  
 BV for Extension [622] 62  
 BV Recording Time [214] 33  
 BV Resource [621] 62  
 BV Total Recording Time [807] 72

### C

Call Duration Counter Start [204] 32  
 Call Forwarding Selection [963] 77  
 Call Forwarding Start Time [202] 32  
 Call Forwarding to CO Line [607] 58  
 Call Log [9-3] 226  
 Call Pickup Tone [117] 28  
 Call Transfer to CO Line [606] 58  
 Call Waiting Caller ID Assignment [913] 76  
 Call Waiting Caller ID CAS Receive Time [914] 76  
 Call Waiting Caller ID Time [908] 75  
 Caller ID [9] 218  
 Caller ID [900] 72  
 Caller ID Area Code [901] 73  
 Caller ID Checksum [915] 77  
 Caller ID Log Priority [904] 74  
 Caller ID Modification for Local Calls [902] 73  
 Caller ID Modification for Long-distance Calls [903] 74  
 Caller ID SMDR Format [906] 74  
 Caller ID SMDR Printout [907] 75  
 Carrier Exception Code [300] 34  
 Carrier Exception Codes [1-8] 138  
 Class of Service (COS) [5-1] 192  
 Clear All OGMs of DISA [599] 56  
 Close 92  
 CO [3] 180  
 CO Indicator [109] 26  
 CO Line Connection [400] 37  
 CO Line Group Number [404] 39  
 CO Line Mode—Day/Night/Lunch [414] 41  
 CO Line Ring Tone Pattern [423] 46  
 Common Area Call Log Check [909] 75

Common/Personal BV OGM Recording Time [215] 34  
 Conference Tone [105] 25  
 Connect 98  
 Console Paired Telephone [004] 20  
 CO-to-CO Line Call Duration [205] 32  
 CPC Signal Detection—Incoming [420] 44  
 CPC Signal Detection—Outgoing [421] 45  
 Cyclic Tone Detection [513] 53

### D

Date & Time [000] 17  
 Date & Time [1-1] 120  
 Default 117  
 Delayed Ringing—Day/Night/Lunch [411] 41  
 Denied Codes [5-2] 193  
 Detail [1-10] 140  
 Detail [3-3] 183  
 Dial Mode [401] 38  
 Dialing Start Time [206] 33  
 DISA [6] 198  
 DISA AA Wait Time [517] 54  
 DISA Built-in AA [501] 48  
 DISA Busy Mode [506] 50  
 DISA Delayed Answer Time [504] 49  
 DISA Incoming Assignment [516] 54  
 DISA Incoming Call Dial Mode [500] 48  
 DISA Intercept Mode [507] 50  
 DISA IRNA to BV—Day/Night/Lunch [438] 48  
 DISA No Dial Mode [510] 51  
 DISA OGM Clear 118  
 DISA Ring Time after Intercept [509] 51  
 DISA Ring Time before Intercept [508] 50  
 DISA Ringback Tone [531] 55  
 DISA Security Code [512] 52  
 DISA Security Code Digits [530] 55  
 DISA Security Mode [511] 51  
 DISA Tone after Security Code [518] 54  
 DISA Wait Time after OGM [505] 49  
 Disconnect 101  
 Disconnect Time [422] 45  
 DND Override [609] 59  
 Door Open Duration [709] 67  
 Door Opener—Day/Night/Lunch [703] 65  
 Doorphone [7] 208  
 Doorphone Access Tone [707] 66  
 Doorphone Chime Assignment [711] 68  
 Doorphone Chime Pattern [712] 68  
 Doorphone Ring Time [708] 67  
 Doorphone Ring Tone Pattern [706] 66  
 Doorphone Ring/Chime [710] 67  
 Doorphone Ringing—Day/Night/Lunch [700] 65  
 DSS Console [2-5] 173  
 DSS Console [2-5] DSS buttons 176  
 DSS Console [2-5] PF buttons 178  
 DSS Console Jack Assignment [003] 19  
 DSS Lamp Mode [112] 27  
 DTMF Integration [103] 25  
 DTMF Integration Port [102] 24  
 DTMF Receiver Check [107] 26

**E**

Emergency Number & Others [5-4] 195  
 Emergency Number [309] 36  
 Entering Characters 16  
 Entering Manager Programming Mode 15  
 Entering System Programming Mode 15  
 Exception Codes [5-3] 194  
 Executive Busy Override [608] 58  
 Exit 96  
 Extension [2] 146  
 Extension Access to Local Carrier-based Voice Mail [437] 47  
 Extension Group [2-6] 178  
 Extension Group [600] 56  
 Extension Name [604] 57  
 Extension Number [009] 22  
 Extension Ring Tone Pattern [115] 27  
 External Pager Access Tone [106] 25

**F**

FAX Connection [503] 49  
 FAX Tone Detection [514] 53  
 Feature settings [2-2] 154  
 File Transfer PBX to PC 94  
 File Transfer PC to PBX 93  
 Firmware Upgrade 112  
 Firmware Version [998] 78  
 Flash/Recall Key Mode [110] 27  
 Flash/Recall Mode for a Locked Extension [108] 26  
 Flash/Recall Time [418] 43  
 Flexible Buttons [2-4] 167  
 Flexible Buttons [2-4] CO buttons 169  
 Flexible Buttons [2-4] Message button 172  
 Flexible Buttons [2-4] PF buttons 171  
 Flexible Outward Dialing—Day/Night/Lunch [405] 40  
 Flexible Ringing—Day/Night/Lunch [408] 40

**H**

Hold Recall Time [200] 31  
 Host PBX Access Code [403] 39  
 Hot Line Waiting Time [203] 32  
 Hunting Group Set [100] 23  
 Hunting Type [101] 24

**I**

Incoming / Outgoing [3-2] 181  
 Incoming Permission [6-3] 207  
 Incoming/Outgoing Call Selection for Printing [802] 70  
 Installing and Starting KX-TA Maintenance Console 82  
 Intercept Time for Internal DISA [515] 53  
 Inter-digit Time [208] 33  
 Introduction 12, 82

**K**

KX-T7700 Series Incoming Lamp Control [968] 78

**L**

LCD Language [615] 60

LCD Time Display [010] 22  
 Line Mode [3-1] 180  
 Local Carrier-based VM [3-4] 188  
 Local Carrier-based Voice Mail Access Dial [436] 47  
 Local Carrier-based Voice Mail Signaling [435] 46

**M**

Main [1-2] 121  
 Main [2-1] 146  
 Main [8-1] 214  
 Main [9-1] 218  
 Message Waiting for Another Extension [618] 61  
 Music on Hold [111] 27

**N**

New 92  
 No Dial Disconnection [211] 33  
 Normal 116  
 Numbering Plan [1-3] 124

**O**

One-touch Transfer Using a DSS Button [005] 20  
 Open 92  
 Operator Assignment [008] 21  
 Others [7-2] 210  
 Others [8-2] 216  
 Overview 11

**P**

Paralleled Telephone [610] 59  
 Password Security 12  
 Pause Time [417] 43  
 PC Programming 82  
 PC Programming—Connect 97  
 PC Programming—File 91  
 PC Programming—Introduction 81  
 PC Programming—Opening Screen 87  
 PC Programming—System Data Setting 119  
 PC Programming—Utility 111  
 PC Programming—View 107  
 Print 95  
 Print ALL 95  
 Profile Editor 102  
 Profile Setup 102  
 Program List 94  
 Programmer Code Change 108  
 PT personal settings [2-3] 162  
 PT Programming 13  
 PT Programming—Instructions 14  
 PT Programming—Procedures 17  
 Pulse Restriction [118] 28  
 Pulse Speed [402] 38

**Q**

Quick Setup 113

**R**

Redialing after Pulse to Tone Conversion [119] 28

## Index

---

Required Telephone 14  
Ringback Tone Pattern [128] 28  
Ringing & Door Opener [7-1] 208  
Room Monitor [612] 60

## S

Save 93  
Save As 93  
Screen Customize 109  
Secret Number SMDR Print Suppression [803] 70  
Settings [6-2] 201  
SLT Caller ID [628] 64  
SLT Caller ID [9-2] 222  
SLT Caller ID Line Access Number [151] 31  
SLT Caller ID Signaling Type [150] 30  
SLT Fixed Bell Pattern [629] 64  
SLT Hold Mode [104] 25  
SLT Message Waiting [619] 61  
SLT Message Waiting [620] 61  
SLT Ring Bell-on Time [143] 30  
SLT Ring Wait Time for New Call [627] 64  
SLT Ring/Silence Ratio [142] 30  
SMDR [1-7] 133  
SMDR Account Code [805] 71  
SMDR Language [806] 72  
SMDR Parameter [801] 69  
SMDR RS-232C Parameter [800] 68  
Software Modes 82, 88  
Standard Buttons 85  
Status Bar 84  
System [1] 120  
System Data Clear 117  
System Data Clear [999] 79  
System Data Dump [804] 70  
System Data Setting Menu 109  
System Password [002] 18  
System Requirements 82  
System Reset 116  
System Speed Dialing [4] 190  
System Speed Dialing [4-1] 190  
System Speed Dialing Name [011] 23  
System Speed Dialing Number [001] 18

## T

TAM Extension [611] 59  
Time Service [1-4] 125  
Time Service [1-4] Time Setting 126  
Time Service Start Time [007] 21  
Time Service Switching Mode [006] 20  
Timers [1-6] 129  
Tool Bar 108  
Transfer Recall Time [201] 31  
TRS 192  
TRS Check for \* and # [125] 28  
TRS Check Time after Answering [967] 78  
TRS—COS 2-5 Denied Code [302-305] 35  
TRS—COS—Day/Night/Lunch [601] 56  
TRS—Exception Code [306] 35  
TRS—Extension Lock Class [312] 37

TRS—System Speed Dialing Class [301] 34

## V

VM 1 APT Port [130] 29  
VM 2 APT Port [131] 29

## W

Wireless PT Port Assignment [617] 60



# DUBUgcb]WHY`Yd\ cbY`GngHya g



See More  
Panasonic Manuals



[www.voicesonic.com](http://www.voicesonic.com)

Phone: 877-289-2829

## Copyright:

This material is copyrighted by Panasonic Communications Co., Ltd., and may be reproduced for internal use only. All other reproduction, in whole or in part, is prohibited without the written consent of Panasonic Communications Co., Ltd.

© 2005 Panasonic Communications Co., Ltd. All Rights Reserved.