

# **Panasonic**

## **Digital Super Hybrid System KX-TD208E**

### **Added and Changed Features for Operating Instructions**

In this manual, the last letter “E” of each model number is omitted.

# Table of Contents

---

## Added Features

### Section 2.3. Making Calls

Quick Dialling.....	18
Redialling .....	18

### Section 2.6. Others

Before Leaving Your Desk – Forwarding a Call (Call Forwarding).....	6, 18
Alarm Setting (Timed Reminder) .....	24
Denying Receiving Calls – Rejecting Incoming Calls (Do Not Disturb (DND)) .....	7
Caller Identification Services (for KX-T7230 / KX-T7235).....	8, 18
Call Forwarding – to CO line .....	18
Selecting the CLIP / COLP Numbers .....	10

### Section 3.1. System Management

Accessing to Other Types of Network Connected to the ISDN .....	11
Class of Service (COS) .....	18
Direct Dialling In (DDI) .....	12
Forwarding a Doorphone Call to the Outside Line .....	13
Removing and Adding the Dialed Number for LCR .....	14

### Section 3.X. System Programming

[205] DTMF Sending PAUSE Time.....	15
[408]–[409] Extension Ringing Assignment – Day/Night for ISDN .....	18
[517] Call Forwarding by ISDN Service.....	16
[614]–[615] Doorphone Call Forwarding – Day/Night.....	16
[701] LCR Carrier Code .....	18, 19
[702] LCR Route Selection Code .....	19
[703] LCR Authorization Code .....	19
[705] BTL Access Code.....	19
[706] LCR Route Exceptional Code.....	19
[707] LCR Leading Digit Entry.....	19
[708] LCR Modify Removed Digit .....	16
[709] LCR Modify Added Number .....	17
[902] System Additional Information.....	17, 19
[903] Received Number Check .....	17

### Section 4.13. Expanding the ISDN Line Connection . . . . . 19

## Changed Features

### Section 2.3. Making Calls

Outside Calling .....	23
Quick Dialling.....	23, 24

### Section 2.5. During a Conversation

Transferring Calls .....	24
Call Waiting .....	24

# Table of Contents

---

<b>Section 2.6. Others</b>	
Privacy Feature .....	25
Calling with Account Codes (Account Code Entry) .....	23
Charge Fee Reference .....	24
Switching the Day/Night Calling Mode (Night Service) .....	23
<b>Section 2.7. Display Operation with the KX-T7235</b>	
Display Operation for FWD/DND.....	25
<b>Section 3.1. System Management</b>	
Class of Service .....	23
Least Cost Routing.....	23
Toll Restriction.....	23
System Data Default Set.....	25
<b>Section 3.3. Manager Programming</b>	
[000] Date and Time Set.....	25
[001] System Speed Dialling Number Set.....	25
<b>Section 3.4. System Programming</b>	
[101] Account Codes.....	23
<b>Section 3.6. TRS Programming</b>	
[300]–[304] TRS Denied Code Entry for Levels 2...6 .....	23
[305]–[309] TRS Excepted Code Entry for Levels 2...6.....	23
<b>Section 3.7. ISDN Port Programming</b>	
[404] CLIP / COLP Number Assignment.....	22
[412] ISDN DDI Number / Extension Number Transformation.....	22
<b>Section 3.8. COS Programming</b>	
[500]–[501] Toll Restriction Level — Day / Night.....	23
[506]–[507] Toll Restriction Level for System Speed Dialling — Day/Night .....	23
<b>Section 3.10. LCR Programming</b>	
[702] LCR Route Selection Code .....	25
[706] LCR Route Exceptional Code.....	25
<b>Section 3.12. Optional Programming</b>	
[901] System Data Clear Except ISDN Data .....	25
[902] System Additional Information.....	23
<b>Section 3.13. PC Programming</b> .....	<b>25</b>
<b>Section 3.14. Programming Table</b> .....	<b>23, 26</b>
<b>Section 5.1. Tones / Ring Tones</b>	
TONE .....	25



# **Added Features**

## 2.6 Others

### Before Leaving Your Desk

#### Forwarding a Call (Call Forwarding)

TYPE	DESCRIPTION
By the ISDN Service –all calls	All calls to your MSN number are forwarded by the ISDN.
By the ISDN Service –when busy	Calls to your MSN are forwarded when you are busy, by the ISDN.
By the ISDN Service –no answer	If you do not answer calls, your MSN will be forwarded by the ISDN.

#### Setting

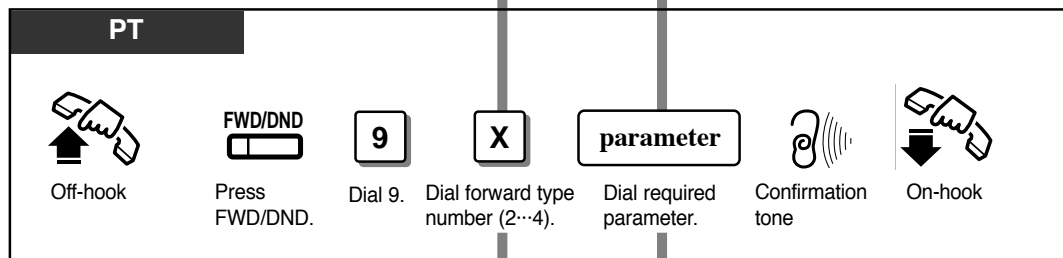
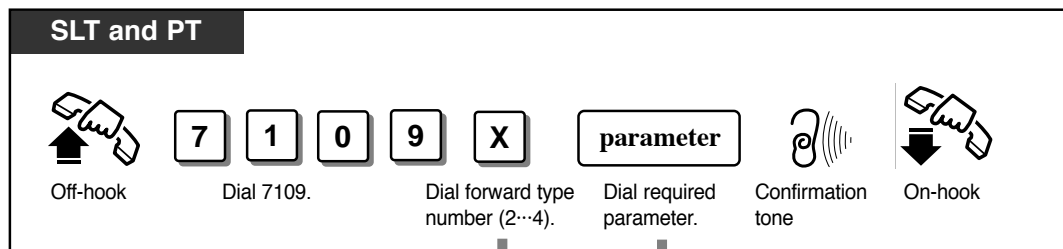

FORWARD TYPE	FORWARD TYPE No.	PARAMETER
By the ISDN Service –all calls	<b>2</b>	
By the ISDN Service –when busy	<b>3</b>	<div style="display: flex; justify-content: space-around; align-items: center;"> <div style="border: 1px solid black; padding: 2px; text-align: center;"><b>ISDN port number</b></div> <div style="border: 1px solid black; padding: 2px; text-align: center;"><b>destination phone no.</b></div> <div style="border: 1px solid black; padding: 2px; text-align: center;"><b>#</b></div> </div>
By the ISDN Service –no answer	<b>4</b>	<div style="display: flex; justify-content: space-around; align-items: center;"> <div style="border: 1px solid black; padding: 2px; text-align: center;">Dial ISDN port number (1,2).</div> <div style="border: 1px solid black; padding: 2px; text-align: center;">Dial destination phone number. (16 digits max.)</div> </div>

## 2.6 Others

### Denying Receiving Calls

#### Rejecting Incoming Calls (Do Not Disturb (DND))

You can reject calls using the following method.

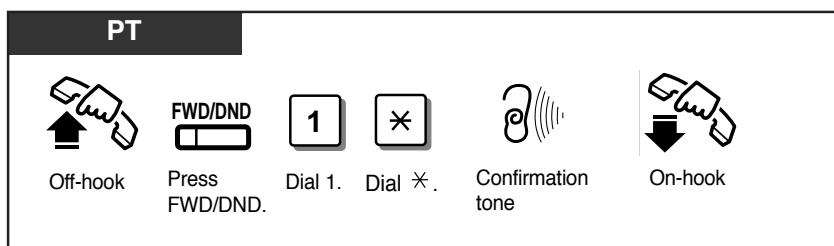
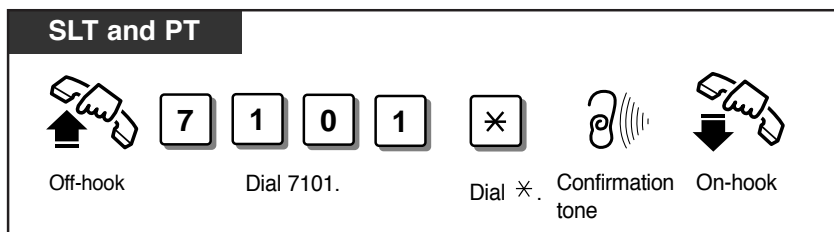

- Depending on the kind of call received, the DND setting will work differently.

Call Type	At your extension	At the other party's extension
Intercom Call	No ring	DND tone
Outside Call at 2 or more extensions (including your extension)	No ring. Informs you with a flashing CO button.	Ringback tone
Outside Call only at your extension	Not received	Busy tone

## 2.6 Others

### Caller Identification Services (for KX-T7230 / KX-T7235)

#### Displaying the Caller's Information (Caller ID)

Provides you with the caller's telephone number and name if you have subscribed to the calling line identification service. You can record the caller's telephone number (and name if assigned) into the call log by pressing LOG button. The sample display is KX-T7230.

#### Display while receiving

While receiving an incoming outside call

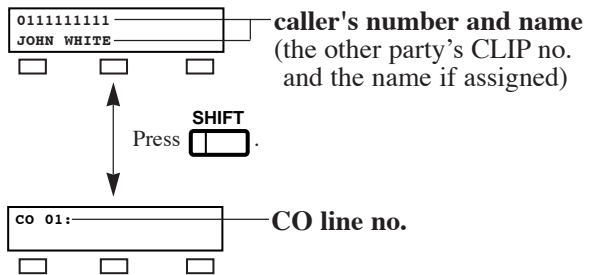

Off hook or press SP-PHONE or MONITOR button.

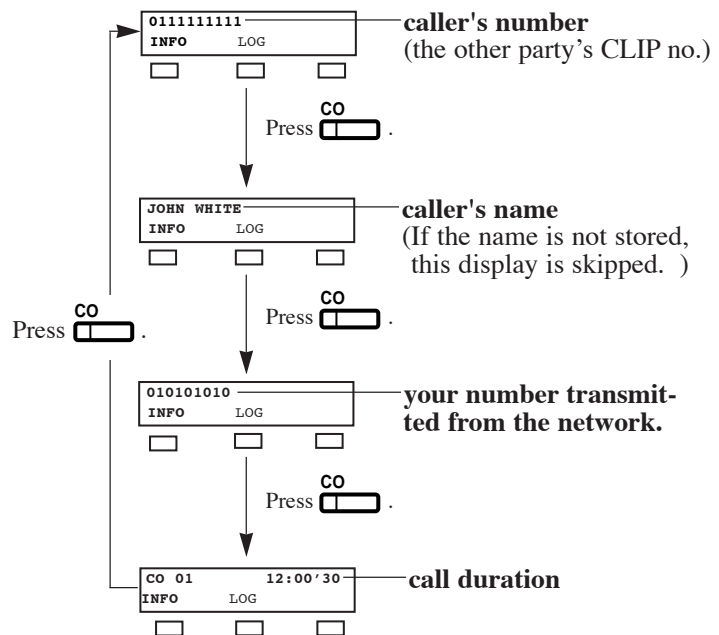

- The caller's name can be stored in the programming for the System Speed Dialling by Personal Computer (PC).
- You can use the INFO button to change the display instead of using the CO button.
- Press SHIFT button to change into the normal display after you go off-hook.



## 2.6 Others

### Display while dialling

Off-hook or press SP-PHONE and dial an outside line access code + the phone number.

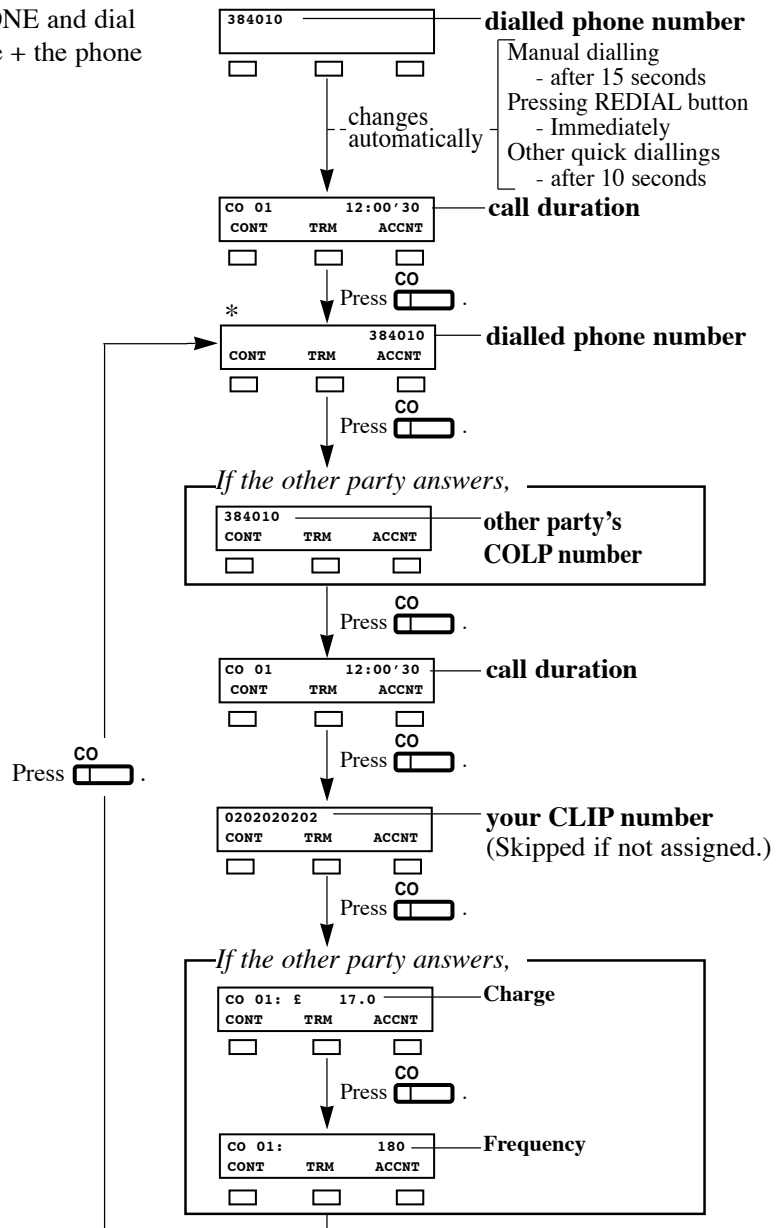

- You can program whether the charge or the frequency comes first to be shown by the System Programming [107].
- If the other party doesn't answer, displays for the other party's COLP number and Charge Information are skipped.
- Your CLIP number is programmable by System Programming [404].
- After the other party answers, the other party's COLP number and the charge information are displayed.
- As soon as the charge information is received, the information is shown on the display and the display after the information shows the dialled phone number (\*) again. (See the above chart.)

## 2.6 Others



- System Programming (Section 3.4)  
[107] Charge Indication Selection
- ISDN Port Programming (Section 3.7)  
[404] CLIP / COLP Number Assignment

### Selecting the CLIP / COLP numbers

You can select the CLIP / COLP numbers to be displayed to the other party depending on business or private use.

#### Setting the CLIP numbers

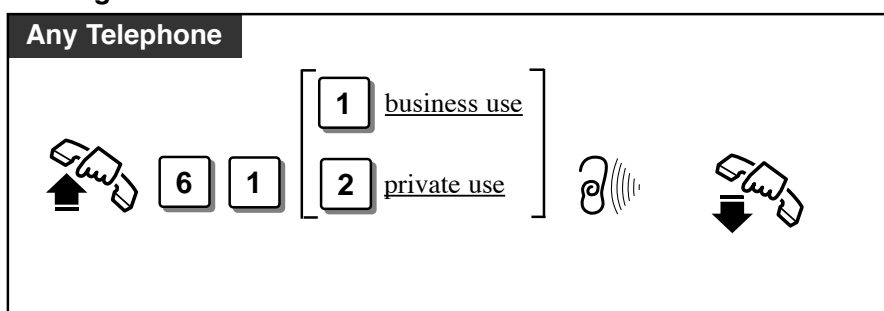

#### Setting the COLP numbers

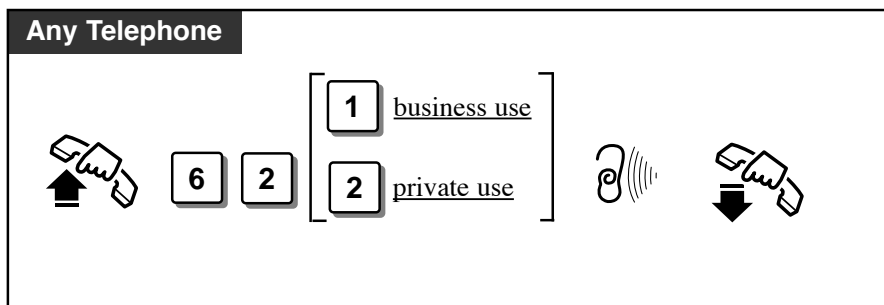

- Your CLIP number will be displayed if the number is assigned by the System Programming [404].
- Caller Identification ( Caller ID ) services can be denied depending on your COS level.
- If you select the same setting previously selected, a confirmation tone 2 and dial tone will be sent.



- ISDN Port Programming (Section 3.7)  
[404] CLIP / COLP Number Assignment
- COS Programming(Section 3.8)  
[512] Calling Line Identification Restriction (CLIR)  
[513] Connected Line Identification Restriction (COLR)
- Extension Programming(Section 3.9)  
[601] Class of Service

## 3.1 System Management

---

<i>Accessing to Other Types of Network Connected to the ISDN</i>	SLT	ISDN-T	PT
	✓	✓	✓

To access other types of network from the ISDN, sending out DTMF may be needed. To send out the dialled number in DTMF, you must insert a PAUSE (“\* \*”). Any digits following the PAUSE will be sent as DTMF.

Some examples of services requiring DTMF – Alternative carriers using analogue networks, Electronic banking



- This feature does not work when manually dialling.
- It is necessary to store a PAUSE in either the LCR Carrier Code or Authorization Code.



- Making Calls (Section 2.3)
  - Quick Dialling
  - Redialling
- System Management (Section 3.1)
  - Least Cost Routing (LCR)
- System Programming (Section 3)
  - [001] System Speed Dialling Number Set
  - [205] DTMF Sending PAUSE Time
  - [701] LCR Carrier Code
  - [703] LCR Authorization Code
  - [704] LCR Itemized Bill Code

## 3.1 System Management

<i>Direct Dialling In (DDI)</i>	SLT	ISDN-T	PT
	✓	✓	✓

Allows the external caller to connect to an extension in the system directly. Assignable destinations are: Operator, extension, or extension group. This requires a DDI number transmitted from the ISDN network. The DDI number is converted to a specific extension number by using a pre-programmed conversion table.

### Explanation

1. An incoming call from the ISDN network reaches your DSHS (Digital Super Hybrid System). The ISDN network informs DSHS of the DDI number.
2. DSHS converts the DDI number to an extension number and directs the call to the extension.

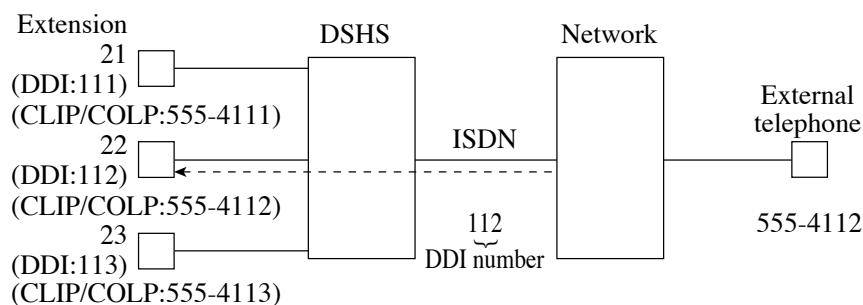

- You can store a DDI number (20 digits maximum) by System Programming.
- To reach an extension group, the group must have been previously stored by System Programming.
- If a wrong number is entered, the call will be transferred to the operator.
- It is possible to use DND on a DDI call if the Class of Service permits.



- System Programming (Section 3)
  - [404] CLIP / COLP Number Assignment
  - [405] Direct Dialling In
  - [412] ISDN DDI Number/Extension Number Transformation
  - [510] Do Not Disturb for Direct Dialling In Call
  - [902] System Additional Information, Area 1 – Field (04)
  - [903] Received Number Check

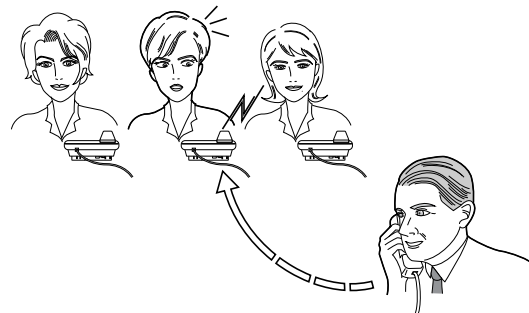

## 3.1 System Management

<i>Forwarding a Doorphone Call to the Outside line</i>	SLT	ISDN-T	PT
	✓	✓	✓

You can automatically transfer an incoming doorphone call to a preset outside destination.



- Even if you set other Call forwarding, this settings are available if pre-programmed by System Programming.
- If there is no answer while the call is being forwarded, the forwarding will stop in one minute.
- Toll restriction and other restrictions such as an account code are not activated.
- A call is not recorded by SMDR for the Call Forwarding.
- There are two different modes for day and night. A different destination can be set in each mode. This feature can be set by System Programming.
- The CLIP number displayed at the destination extension is the number assigned at Extension 21.



- System Programming (Section 3)
  - [404] CLIP / COLP Number Assignment
  - [614]–[615] Doorphone Call Forwarding – Day / Night

### 3.1 System Management

<b>Removing and Adding the Dialed Number for LCR</b>	SLT	ISDN-T	PT
	✓	✓	✓

The dialed number is modified for sending out to the least expensive carrier. See below as an example.

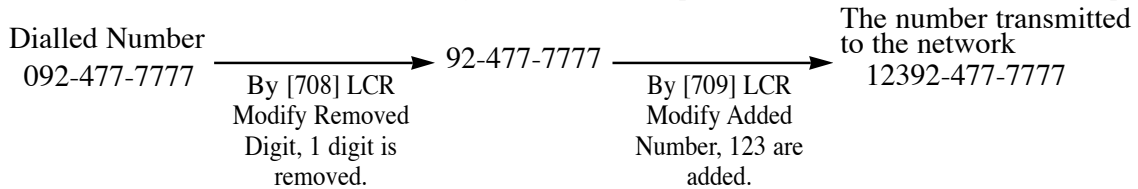

\* For the example above, the carrier code, authorization code and itemized bill code are omitted.

#### Flow Chart of LCR

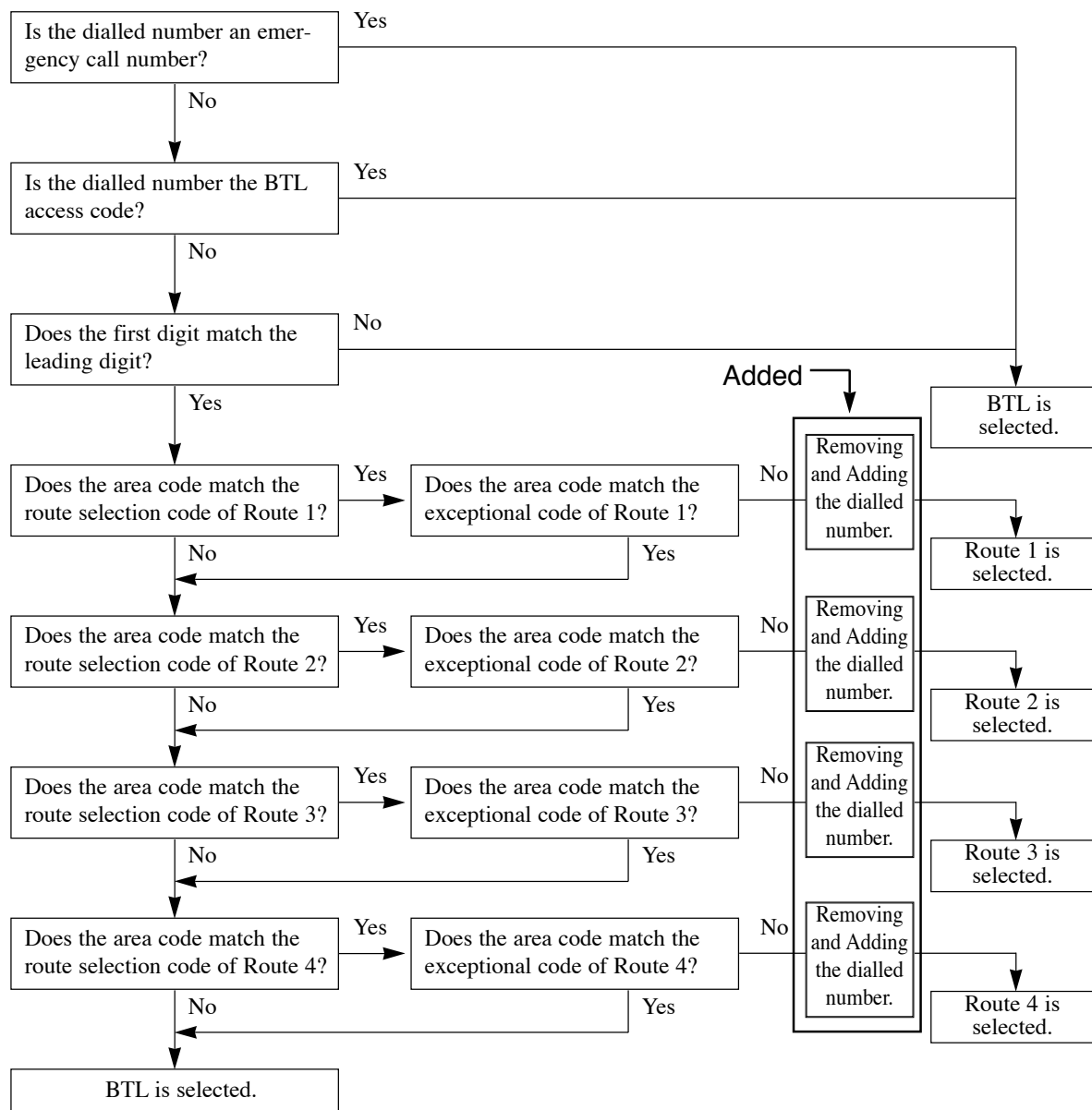

## 3.1 System Management

---

To activate this feature, please add the following new System Programming to **the LCR Routing Plan Tables (Routes 1 through 4)**



(6) **LCR Modify Removed Digit** (Program [708])

This is used to remove the digits of the dialled number before sending to the exchange line.

(7) **LCR Modify Added Number** (Program [709])

This is used to add the number to the dialled number before sending to the exchange line.

- Making Calls (Section 2.3)
  - Outward Dialling
- LCR Programming (Section 3.10)
  - [708] LCR Modify Removed Digit
  - [709] LCR Modify Added Number

## 3. System Programming

[205]

### [205] *DTMF Sending PAUSE Time*

Assigns the starting time for sending out the DTMF signalling to the ISDN Network.

(1...6)

**X** – X + 0.5 sec.

**DEFAULT** 1.5 seconds (1 + 0.5 sec.)

**CHANGE** \_\_\_\_\_ seconds



**[517] Call Forwarding by ISDN Service**

Enables or disables the Call Forwarding by ISDN Service function on a Class of Service (COS) basis.

**5** **1** **7** **COS no.** **X** **#**  
 (1...4,\*) (1...2)

**X** – Selection number: 1 (Enable) / 2 (Disable)



**DEFAULT** All COS – Disable

**CHANGE** The Programming Table is on page 30.

**[614]-[615] Doorphone Call Forwarding – Day/Night**

Assigns the destination phone number to the system for forwarding an incoming doorphone call.

**6** **1** **Y** **ISDN port access code (9, 81, 82) + destination phone no.** **#**  
 (4...5) (20 digits max. 0...9,\*)

**Y** – Program address selection number: 4 ([614] for day) / 5 ([615] for night)



- Enter “\* \*” for a PAUSE. The PAUSE is counted as two digits.
- To delete the current entry, press # after entering the programming address.



**DEFAULT** Not stored.

**CHANGE** ISDN port access code + destination phone no.

for day \_\_\_\_\_

for night \_\_\_\_\_

**[708] LCR Modify Removed Digit**

Determines how the dialled number should be modified before sending to the exchange line. The digits are deleted from the beginning of the dialled number.

**7** **0** **8** **route no.** **number of digits to be deleted** **#**  
 (1...4) (0...9)



**DEFAULT** All routes – 0 digit (no deletion)

**CHANGE** The Programming Table is on page 31.

#### [709] LCR Modify Added Number

Determines how the dialled number should be modified before sending to the exchange line. Numbers are added to the beginning of the dialled number.

7	0	9	route no.	number to be added	#
			(1...4)	(0...9, 9 digits maximum)	

**!** • To delete the current entry, press # after entering the route number.

- DEFAULT** All routes – Not stored
- CHANGE** The Programming Table is on page 31.

#### [902] System Additional Information

Assigns the additional programming items, if required. There are 00 through 15 fields in each Area 1 through 4.

9	0	2	area code	field no.	selection no*	#
			(1...4)	(00...15)	(0...1)	

\* Refer to “**Selection**” shown in the lists.

- DEFAULT** Refer to “**Default**” shown in the lists.
- CHANGE** Write the change, if any, into “**Change**” shown in the lists.

#### Explanation for Area 3

Field	Description	Selection	Default	Change	Reference
12	Selects whether a tone or internal music is used for music on hold.	0 : tone 1 : music	0		None

#### [903] Received Number Check

Indicates the number of the last outside incoming call which was transmitted from the ISDN network on PC or on the display of the PT.

9	0	3	X	#
(1...2)				

**X** – Selection number: 1 (indicates the leading 16 digits)  
2 (indicates from 17th to 20th digit)

- !**
- You can also check this number by PC.
    - (1) Starts PC programming.
    - (2) Selects “Received Number Check”.

## Other added items

Section of O/I	Feature Title	Item
2.3 Making Calls (P2-15)	Quick Dialling Dialling Simply by Pressing a Button (One-Touch Dialling)	Please add the following to the conditions. • If there is a PAUSE in the assigned numbers, the numbers after the PAUSE are sent as DTMF signals.
2.3 Making Calls (P2-20)	Redialling Redialling the Last Dialled Number (Last Number Redial)	
2.3 Making Calls (P2-21)	Redialling the Saved Number (Saved Number Redial)	
2.3 Making Calls (P2-16)	Quick Dialling Dialling with a System Speed Dialling Button (System Speed Dialling)	Please add the following to the conditions. • The caller's name is programmable by PC programming. To indicate the name on the display while receiving the call, you must store the caller's phone number with ' - ' (hyphen) after the line access code.
2.3 Making Calls (P2-19)	Quick Dialling Dialling with a SAVE Button in Memo (Notebook Function)	Please add the following to the conditions. • When you store the phone number during a conversation, the current stored ISDN port access code is used. In on-hook status, the ISDN port access code is automatically chosen as '9'.
2.6 Others (P2-40)	Before Leaving Your Desk Forwarding a Call (Call Forwarding)	Please add the following to the conditions. • You can use ' * * ' to store a PAUSE. 0 through 9 and * are assignable.(Call Forwarding To CO line)
2.6 Others (P2-73)	Caller Identification Services (for KX-T7230 / KX- T7235) Recording the caller's Information (Incoming Call Log)	Please add the following to the conditions. • While you are talking to the outside line, your extension also automatically records its call information. (KX-T7235, KX-T7230)
3.1 System Management (P3-2)	Class of Service (COS)	Please add the following programming items. 12) Sets Call Forwarding by ISDN Service Please add the following programming address. [517] Call Forwarding by ISDN Service
3.7 ISDN Port Programming (P3-36)	[408]–[409] Extension Ringing Assignment — Day/Night for ISDN	Please add the following to Y, Delayed ringing selection. number 9 (disable) Please add the extension numbers 31...34. The Programming Table is on page 28.
3.10 LCR Programming (P3-46)	[701] LCR Carrier Code	Please add the following to the conditions. • To delete the current entry, press # after entering the route number.

Section of O/I	Feature Title	Item
3.10 LCR Programming (P3-46)	[702] LCR Route Selection Code [706] LCR Route Exceptional Code	Please add the following to the conditions. • To delete the current entry, press # after entering the area code.
3.10 LCR Programming (P3-46)	[703] LCR Authorization Code	Please add the following to the conditions. • To delete the current entry, press # after entering the ISDN port number.
3.10 LCR Programming (P3-46)	[705] BTL Access Code [707] LCR Leading Digit Entry	Please add the following to the conditions. • To delete the current entry, press # after entering the programming address.
3.10 LCR Programming (P3-46)	[701] LCR Carrier Code [703] LCR Authorization Code	Please add the following to the conditions. • Enter ' * * ' to pause then send the remaining digits as DTMF.
3.10 LCR Programming (P3-46)	[702] LCR Route Selection Code [706] LCR Route Exceptional Code	Please add the following to the conditions. • * is used as a wildcard character that stands for any digit in a phone number.
3.12 Optional Programming (P3-53)	[902] System Additional Information Explanation for Area 2 Field 12	To make this assignment effective, you must press the system reset switch after programming.
4.13 Expanding the ISDN Line Connection (P4-15)		Please add the following to the conditions. • The pin number assignment changes depending on how the extension / CO line switch socket is adjusted. (Refer to 4-14 of the Operating Instructions.),



## **Changed Features**

The whole programming content has been changed except the programming address.

### [404] *CLIP / COLP Number Assignment*

Assigns the Calling Line Identification Presentation (CLIP) and Connected Line Identification Presentation (COLP) numbers, classifying into the business and private modes.

4	0	4	ISDN port no.	extension no.*	X	CLIP/COLP no.	#
			(1...2, *)	(1...4, *)		20 digits max. (0...9)	

\* Extension number: 21 through 28 / 31 through 34 / 301 through 308 (ISDN extension) / 300 (all ISDN extensions)

X – CLIP / COLP Classification 1 : CLIP no. -Business  
 2 : CLIP no. -Private  
 3 : COLP no. -Business  
 4 : COLP no. -Private  
 \*: All



- To delete the entry, press # after entering CLIP / COLP Classification.



**DEFAULT** All CLIP/COLP numbers – Not stored.  
**CHANGE** The Programming Table is on page 26.

The programming method and conditions have been changed.

### [412] *ISDN DDI Number/Extension Number Transformation*

Used to convert a DDI number to an extension number in order to put an incoming DDI call to a specific extension.

4	1	2	ISDN port no.	extension no.*	DDI no.	#
			(1...2, *)		20 digits max. (0...9)	

\* Extension number: 21 through 28 / 31 through 34 / 291 through 298 (UCD Group or Ring Group) / 301 through 308 (ISDN extension) / 300 (all ISDN extensions)



- Please see [903] for your reference.
- To delete the entry, # after entering the extension number.



**DEFAULT** All DDI numbers – Not stored.  
**CHANGE** The Programming Table is on page 27.

Please change the word, Toll Restriction into Call Barring on the following pages.

Section of O/I	Feature Title
P8-9,	Contents
2.3 Making Calls (P2-12, 14) (P2-16)	Outside Calling Quick Dialling
2.6 Others (P2-53...54) (P2-67...68)	Calling with Account Codes (Account Code Entry) Switching the Day/Night Calling Mode (Night Service)
3.1 System Management (P3-3) (P3-12) (P3-17...22)	Class of Service Least Cost Routing Toll Restriction
3.4 System Programming (P3-28)	[101] Account Codes
3.6 TRS Programming (P3-33)	[300]–[304] TRS Denied Code Entry for Levels 2...6 [305]–[309] TRS Excepted Code Entry for Levels 2...6
3.8 COS Programming (P3-38) (P3-39)	[500]–[501] Toll Restriction Level — Day / Night [506]–[507] Toll Restriction Level for System Speed Dialling — Day/Night
3.12 Optional Programming (P3-52)	[902] System Additional Information Explanation for Area 2 Field 03
3.14 Programming Tables (P3-62)  (P3-63)	[500]–[501] Toll Restriction Level — Day / Night [506]–[507] Toll Restriction Level for System Speed Dialling — Day / Night
5.4 Default Values (P5-10)	
5.5 Specifications (P5-14)	

## Other changed items

Section of O/I	Feature Title	Item
2.3 Making Calls (P2-17) 2.3 Making Calls (P2-18) 2.3 Making Calls (P2-19)	Quick Dialling Dialling with a Station Speed Dialling Button (Station Speed Dialling) Dialling Simply by Going Off-Hook (Pickup Dialling) Dialling the Stored Number with a SAVE Button (Notebook Function)	Please replace as follows in the conditions; <ul style="list-style-type: none"> <li>•...Enter “* *” for a “-” (hyphen).</li> </ul> <p style="text-align: center;">↓</p> <ul style="list-style-type: none"> <li>• Enter “* *” for a PAUSE.</li> <li>• If there is a PAUSE in the assigned numbers, the numbers after the PAUSE are sent as DTMF signals.</li> </ul>
2.3 Making Calls (P2-19)	Quick Dialling Dialling with a SAVE Button in Memo (Notebook Function)	Please change as follows. <ul style="list-style-type: none"> <li>• When you store the phone number, you don't have to dial ISDN port access code(9, 81 or 82).</li> <li>• The ISDN port access numbers are '9', '81' and '82'.</li> </ul>
2.5 During a Conversation (P2-34)	Transferring Calls	For the operation, Transferring a Call to CO Line (Call Transfer — to CO Line), you must perform the following operations, Wait for an answer and Announce, even though the manual states “Omit if not necessary.” Please execute in proper order.
2.5 During a Conversation (P2-35)	Call Waiting	If this operation is performed, the current call will be held instead of being terminated. <div style="border: 1px solid black; padding: 10px; margin: 10px 0;"> <p style="text-align: center;"><b>PT</b></p> <p style="text-align: center;"><i>While hearing a Call Waiting tone;</i></p> <div style="display: flex; align-items: center; justify-content: center;"> <div style="border: 1px solid black; padding: 2px; margin: 0 5px;">CO</div> <div style="margin: 0 10px;">OR</div> <div style="border: 1px solid black; padding: 2px; margin: 0 5px;">INTERCOM</div> </div> <div style="display: flex; align-items: center; justify-content: center; margin-top: 5px;"> <p style="font-size: small;">Talk to the new caller.</p> </div> <p style="font-size: x-small; text-align: center;">Press flashing CO or INTERCOM.</p> </div>
2.6 Others (P2-48)	Alarm Setting (Timed Reminder)	Please add the following condition; <ul style="list-style-type: none"> <li>• If you receive an incoming call, ringing starts after the alarm stops sounding.</li> </ul> <p style="text-align: center;">↓</p> <ul style="list-style-type: none"> <li>• If you receive an incoming outside call in the 1:N status during the alarm, ringing starts after the alarm stops sounding.</li> </ul>
2.6 Others (P2-55, 56)	Charge Fee Reference	Please change the PROGRAMMING INPUT for both SLT and PT. <p>Sets the new rate (0. XX Pound)</p> <div style="border: 1px solid black; padding: 2px; display: inline-block; margin-bottom: 5px;"><b>new rate (XX)</b></div> <p style="font-size: x-small; text-align: center;">(2 digits)</p> <p style="text-align: center;">↓</p> <p>Sets the new rate (XXXXXXXX Pound)</p> <div style="display: flex; align-items: center; justify-content: center; margin-bottom: 5px;"> <div style="border: 1px solid black; padding: 2px; margin-right: 10px;"><b>ISDN port no.</b></div> <div style="border: 1px solid black; padding: 2px;"><b>new rate (XXXXXXXX)</b></div> </div> <p style="font-size: x-small; text-align: center;">(1...2, * )                      (The decimal point is a floating digit.)</p>



### 3.14 Programming Tables

[404] CLIP/COLP Number Assignment				
Default : all	Not Stored			
	CLIP no. (Business)		CLIP no. (Private)	
	Port 1	Port 2	Port 1	Port 2
All				
Ext. 21				
22				
23				
24				
25				
26				
27				
28				
31				
32				
33				
34				
300 or 30				
301				
302				
303				
304				
305				
306				
307				
308				

[404] CLIP/COLP Number Assignment				
Default : all	Not Stored			
	COLP no. (Business)		COLP no. (Private)	
	Port 1	Port 2	Port 1	Port 2
All				
Ext. 21				
22				
23				
24				
25				
26				
27				
28				
31				
32				
33				
34				
300 or 30				
301				
302				
303				
304				
305				
306				
307				
308				

### 3.14 Programming Tables

---

[412] ISDN DDI Number/Extension Number Transformation		
Default : all	Not Stored	
	DDI no. (Port 1)	DDI no. (Port 2)
All		
Ext. 291		
292		
293		
294		
295		
296		
297		
298		
300 or 30		
301		
302		
303		
304		
305		
306		
307		
308		

[412] ISDN DDI Number/Extension Number Transformation		
Default : all	Not Stored	
	DDI no. (Port 1)	DDI no. (Port 2)
All		
Ext. 21		
22		
23		
24		
25		
26		
27		
28		
31		
32		
33		
34		

### 3.14 Programming Tables

MSN LocNo.	Extension No.	[408] Extension Ringing Assignment – Day for ISDN						[409] Extension Ringing Assignment – Night for ISDN																		
		All ISDN ports			ISDN port 1			ISDN port 2			All ISDN ports			ISDN port 1			ISDN port 2									
		I	1	3	6	9	I	1	3	6	9	I	1	3	6	9	I	1	3	6	9	I	1	3	6	9
01	Def. : all	✓					✓					✓					✓					✓				
	All exts																									
	Ext. 21																									
	22																									
	23																									
	24																									
	25																									
	26																									
	27																									
	28																									
	31																									
	32																									
	33																									
	34																									
02	Def. : all	✓					✓					✓					✓					✓				
	All exts																									
	Ext. 21																									
	22																									
	23																									
	24																									
	25																									
	26																									
	27																									
	28																									
	31																									
	32																									
	33																									
	34																									

<Note> I : Immediate, 1 : 1 ring delay, 3 : 3 ring delay, 6 : 6 ring delay, 9 : disable

### 3.14 Programming Tables

		[408] Extension Ringing Assignment – Day for ISDN															[409] Extension Ringing Assignment – Night for ISDN																			
MSN LocNo.	Extension No.	All ISDN ports					ISDN port 1					ISDN port 2					All ISDN ports					ISDN port 1					ISDN port 2									
		I	1	3	6	9	I	1	3	6	9	I	1	3	6	9	I	1	3	6	9	I	1	3	6	9	I	1	3	6	9	I	1	3	6	9
03	Def. : all	✓					✓					✓					✓					✓					✓					✓				
	All exts																																			
	Ext. 21																																			
	22																																			
	23																																			
	24																																			
	25																																			
	26																																			
	27																																			
	28																																			
	31																																			
	32																																			
	33																																			
	34																																			
04	Def. : all	✓					✓					✓					✓					✓					✓					✓				
	All exts																																			
	Ext. 21																																			
	22																																			
	23																																			
	24																																			
	25																																			
	26																																			
	27																																			
	28																																			
	31																																			
	32																																			
	33																																			
	34																																			
05	Def. : all	✓					✓					✓					✓					✓					✓					✓				
	All exts																																			
	Ext. 21																																			
	22																																			
	23																																			
	24																																			
	25																																			
	26																																			
	27																																			
	28																																			
	31																																			
	32																																			
	33																																			
	34																																			

<Note> I : Immediate, 1 : 1 ring delay, 3 : 3 ring delay, 6 : 6 ring delay, 9 : disable

### 3.14 Programming Tables

		[408] Extension Ringing Assignment – Day for ISDN									[409] Extension Ringing Assignment – Night for ISDN																				
MSN LocNo.	Extension No.	All ISDN ports					ISDN port 1				ISDN port 2				All ISDN ports					ISDN port 1				ISDN port 2							
		I	1	3	6	9	I	1	3	6	9	I	1	3	6	9	I	1	3	6	9	I	1	3	6	9	I	1	3	6	9
06	Def. : all	✓					✓					✓					✓					✓					✓				
	All exts																														
	Ext. 21																														
	22																														
	23																														
	24																														
	25																														
	26																														
	27																														
	28																														
	31																														
	32																														
	33																														
	34																														
07	Def. : all	✓					✓					✓					✓					✓					✓				
	All exts																														
	Ext. 21																														
	22																														
	23																														
	24																														
	25																														
	26																														
	27																														
	28																														
	31																														
	32																														
	33																														
	34																														
08	Def. : all	✓					✓					✓					✓					✓					✓				
	All exts																														
	Ext. 21																														
	22																														
	23																														
	24																														
	25																														
	26																														
	27																														
	28																														
	31																														
	32																														
	33																														
	34																														

<Note> I : Immediate, 1 : 1 ring delay, 3 : 3 ring delay, 6 : 6 ring delay, 9 : disable

	Selection	Default	COS No.				
		All COS	All COS	COS 1	COS 2	COS 3	COS 4
[517] Call Forwarding by ISDN Service	Enable						
	Disable	✓					

### 3.14 Programming Tables

		[408] Extension Ringing Assignment – Day for ISDN															[409] Extension Ringing Assignment – Night for ISDN																			
MSN LocNo.	Extension No.	All ISDN ports					ISDN port 1					ISDN port 2					All ISDN ports					ISDN port 1					ISDN port 2									
		I	1	3	6	9	I	1	3	6	9	I	1	3	6	9	I	1	3	6	9	I	1	3	6	9	I	1	3	6	9	I	1	3	6	9
09	Def. : all	✓					✓					✓					✓					✓					✓					✓				
	All exts																																			
	Ext. 21																																			
	22																																			
	23																																			
	24																																			
	25																																			
	26																																			
	27																																			
	28																																			
	31																																			
	32																																			
	33																																			
	34																																			
10	Def. : all	✓					✓					✓					✓					✓					✓					✓				
	All exts																																			
	Ext. 21																																			
	22																																			
	23																																			
	24																																			
	25																																			
	26																																			
	27																																			
	28																																			
	31																																			
	32																																			
	33																																			
	34																																			

<Note> I : Immediate, 1 : 1 ring delay, 3 : 3 ring delay, 6 : 6 ring delay, 9 : disable

	[701] LCR Carrier Code	[708] LCR Modify Removed Digir	[709] LCR Modify Added Number
	Carrier code 10 digits max.	0..9 digits	0..9, 9 digits maximum
Default: all	Not stored	0 digit	Not stored
Route 1			
Route 2			
Route 3			
Route 4			

[703] LCR Authorization Code			
Authorization code (20 digits max.)			
	All ISDN ports	ISDN Port 1	ISDN Port 2
Default: all		Not Stored	
Route 1			
Route 2			
Route 3			
Route 4			

### 3.14 Programming Tables

	<b>[702] LCR Route Selection Code</b>			
Area No.	Area Code (6 digits max.)			
	Default : All – Not Stored			
	Route 1	Route 2	Route 3	Route 4
00				
01				
02				
03				
04				
05				
06				
07				
08				
09				
10				
11				
12				
13				
14				
15				
16				
17				
18				
19				
20				
21				
22				
23				
24				
25				
26				
27				
28				
29				
30				
31				
32				
33				
34				
35				
36				
37				
38				
39				

### 3.14 Programming Tables

	<b>[702] LCR Route Selection Code</b>			
Area No.	Area Code (6 digits max.)			
	Default : All – Not Stored			
	Route 1	Route 2	Route 3	Route 4
40				
41				
42				
43				
44				
45				
46				
47				
48				
49				
50				
51				
52				
53				
54				
55				
56				
57				
58				
59				
60				
61				
62				
63				
64				
65				
66				
67				
68				
69				
70				
71				
72				
73				
74				
75				
76				
77				
78				
79				

### 3.14 Programming Tables

	[706] LCR Route Exceptional Code			
Area No.	Area Code (6 digits max.)			
	Default : All – Not Stored			
	Route 1	Route 2	Route 3	Route 4
00				
01				
02				
03				
04				
05				
06				
07				
08				
09				
10				
11				
12				
13				
14				
15				
16				
17				
18				
19				
20				
21				
22				
23				
24				
25				
26				
27				
28				
29				
30				
31				
32				
33				
34				
35				
36				
37				
38				
39				

### 3.14 Programming Tables

	[706] LCR Route Exceptional Code			
Area No.	Area Code (6 digits max.)			
	Default : All – Not Stored			
	Route 1	Route 2	Route 3	Route 4
40				
41				
42				
43				
44				
45				
46				
47				
48				
49				
50				
51				
52				
53				
54				
55				
56				
57				
58				
59				
60				
61				
62				
63				
64				
65				
66				
67				
68				
69				
70				
71				
72				
73				
74				
75				
76				
77				
78				
79				

