



Freestyle 1500 Plus

User guide



*Please turn this page for the 'At a glance' guide
to your Freestyle 1500 Plus*

At a glance

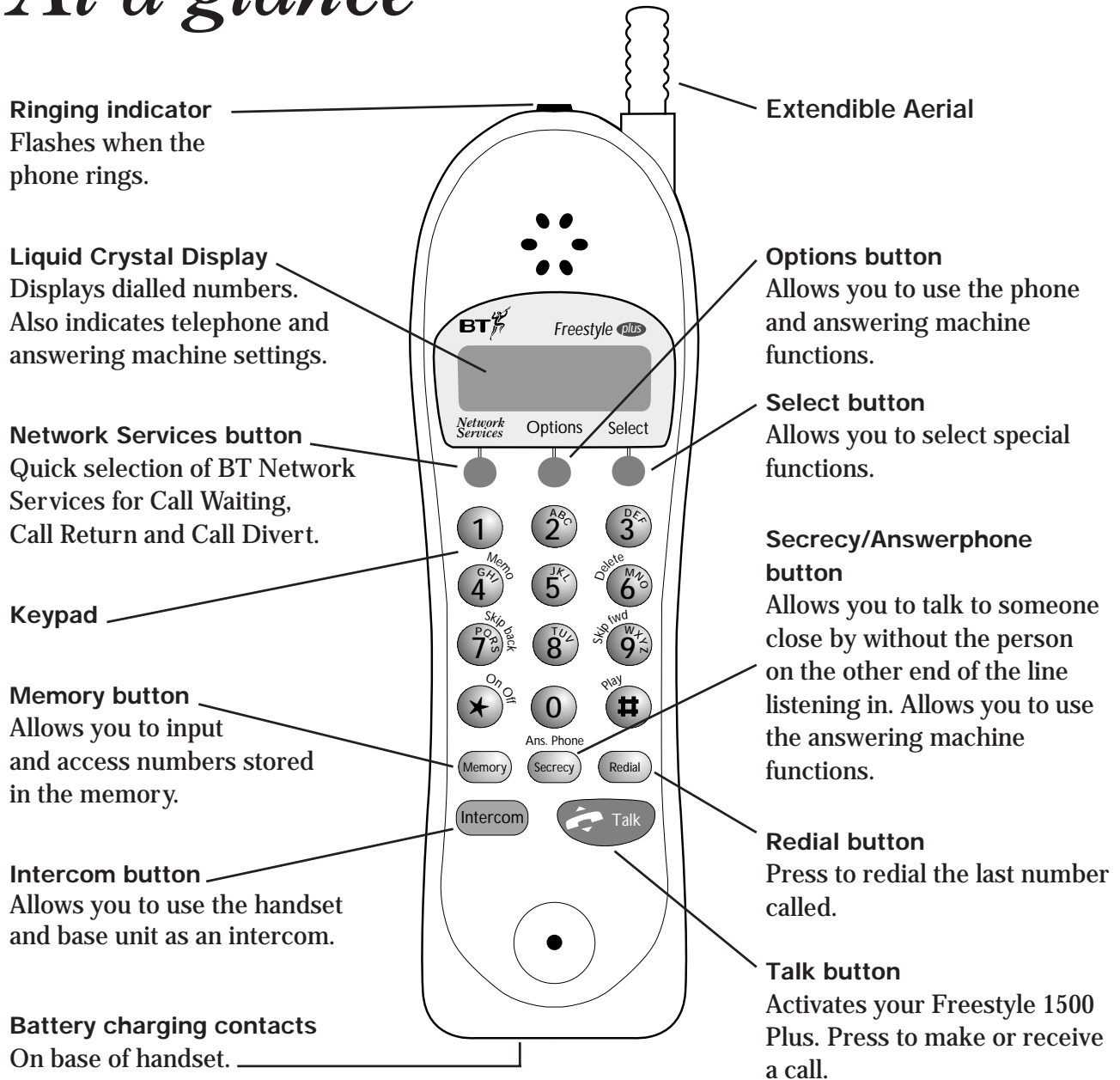

Freestyle 1500 Plus base unit at a glance

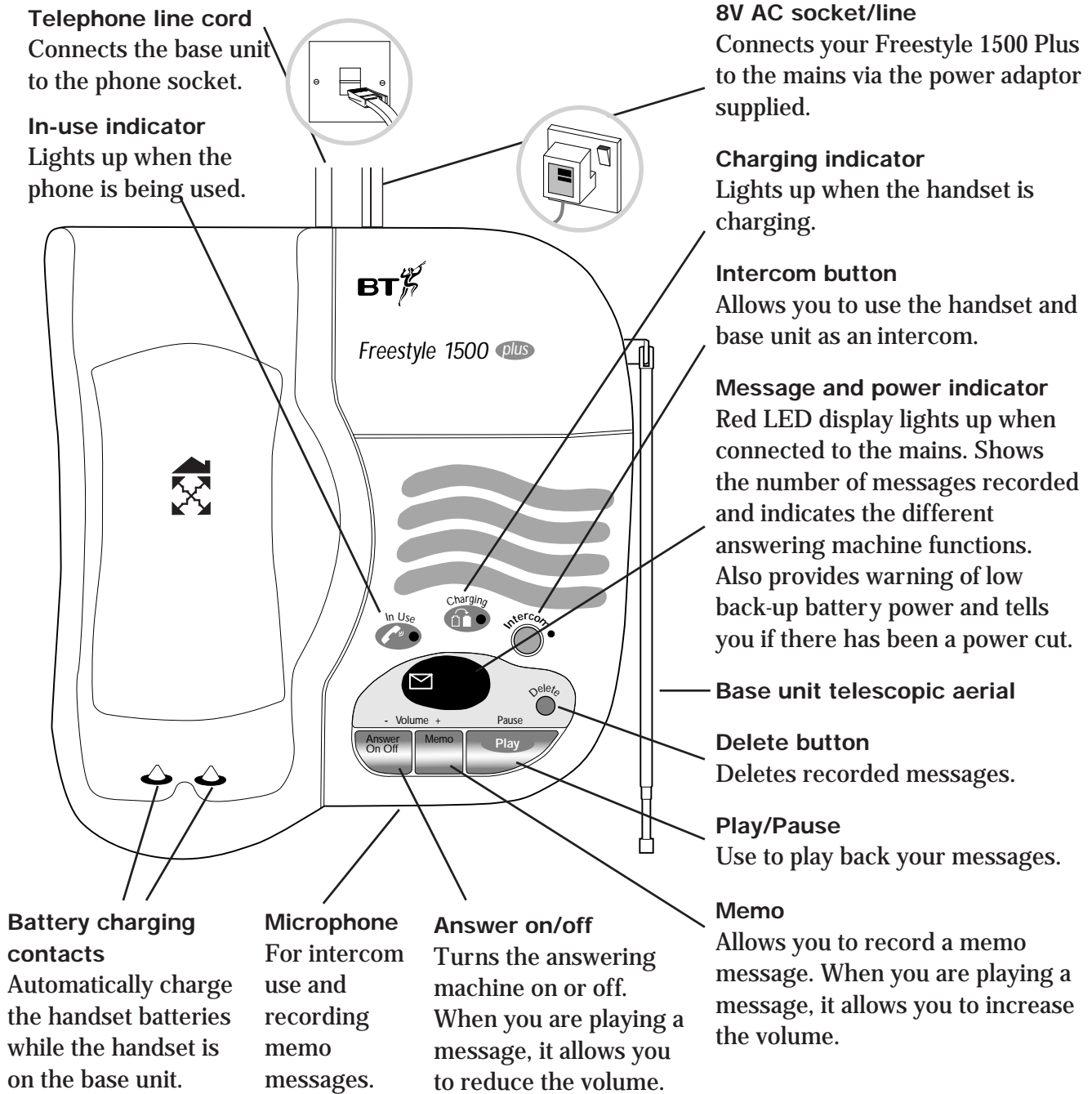

In this guide

<i>At a glance</i>	<i>1</i>
<i>Introduction</i>	<i>4</i>
<i>Setting up</i>	<i>5</i>
<i>How to use your Freestyle 1500 Plus</i>	<i>12</i>
<i>Using the answering machine</i>	<i>20</i>
<i>Additional features</i>	<i>33</i>
<i>Freestyle Plus Additional Handsets</i>	<i>38</i>
<i>Help</i>	<i>41</i>
<i>Technical information</i>	<i>46</i>
<i>Index</i>	<i>48</i>

Hints and tips boxes

In this user guide, we've included helpful tips and useful notes. They are shown in a grey box.

Introduction *Your Freestyle 1500 Plus is designed for ease of use and made to the high standards set by BT.*

Thank you for making the right choice. You can expect many years of quality service.

Please read the instructions carefully before use and keep this user guide for future reference.

For your records

Date of purchase:

Place of purchase:

Serial number (on base of telephone):

Purchase price:

(for warranty purposes, proof of purchase is required, so please keep your receipt)

You can buy extension phones without fitting extension sockets

The Homepoint Plus symbol (as shown below) on the Freestyle 1500 Plus shows that you can buy extra handsets (up to a maximum of three) displaying the same symbol to extend your phone system whenever you want, without the need to install extension sockets at each location.



Homepoint Plus

Please note

Only Freestyle Plus Additional Handsets (Item Code: 871156) can be used with this product. If buying additional handsets for your Freestyle 1500 Plus, please ensure you purchase the correct type.

Setting up Follow these steps and your Freestyle 1500 Plus will be ready for use.

Important:

Before you use your Freestyle 1500 Plus

As this product is rechargeable, it is normal that a certain amount of heat will be produced in its day-to-day operation. Whilst this is entirely safe we would advise against placing this product on antique, veneered or wooden surfaces as damage may occur.

Plan where you will put Freestyle 1500 Plus. The following points should be considered:

- *The base unit should be within two metres of a power socket and the phone socket. A new style phone line socket is needed for this product. If you do not have one, call us free on 150 (BT customers only).*
- *There should be enough room for the telescopic aerial to be fully extended.*
- *Ensure that the base unit and the aerial are away from TV sets, fridges, computers, GSM telephones, fluorescent lights, radiators, metal pipes and metal window frames.*
- *To retain messages through a power cut, you must fit back-up batteries in case of power cuts. The required battery type is a PP3 Alkaline 9V (not supplied).*
- *The back up battery must be fitted before attaching the base unit to the mounting bracket.*

Check that your Freestyle 1500 Plus is complete. When you unpack you should have:

- base unit with telescopic aerial and telephone line cord attached
- handset
- 13 amp mains power adaptor plug
- stand/wall-mounting bracket
- two screws and wallplugs for wall-mounting the base unit
- reminder card – a quick guide for remote access

*Like all cordless phones, your Freestyle 1500 Plus handset will need charging for **24 hours** before use.*

1 Handset aerial

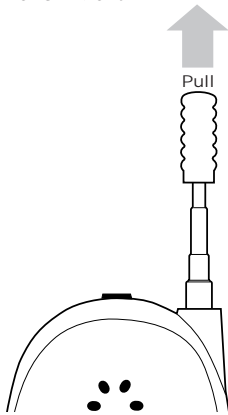

Your Freestyle 1500 Plus uses an extendible aerial. When using the handset pull out the aerial to ensure the best possible signal and reception.

2 Check your telephone wall socket

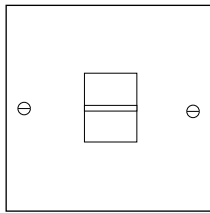

If you do not have a modern socket, call BT on **Freephone 0800 800 150** and ask for an engineer to come and fit the right socket within two metres of a mains socket. This is a chargeable service.

3 Insert battery (for back-up only)

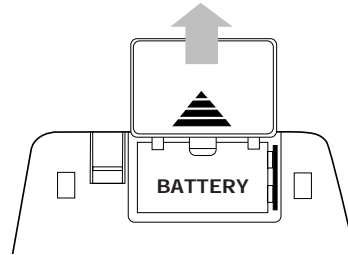

Open the cover panel underneath the base unit. Fit a PP3 9 volt battery (not supplied) and replace the panel. The battery will only be fully connected and functioning when the cover is fully shut.

The battery provides back-up power to ensure that your Freestyle 1500 Plus will work and keep your messages in the event of a mains power failure. We strongly advise you to fit a battery if a cordless phone is the only phone in your home.

Insert the back-up battery before attaching the wall-mounting bracket.

4 Clip the base unit onto the stand

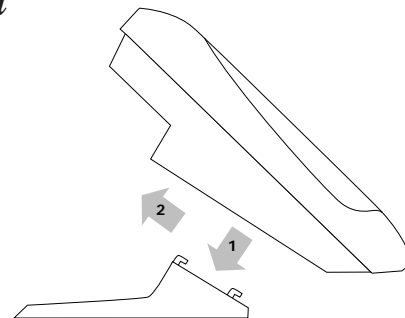

Your Freestyle 1500 Plus features a safety clip on the underside of the base which prevents the stand coming away from the unit accidentally.

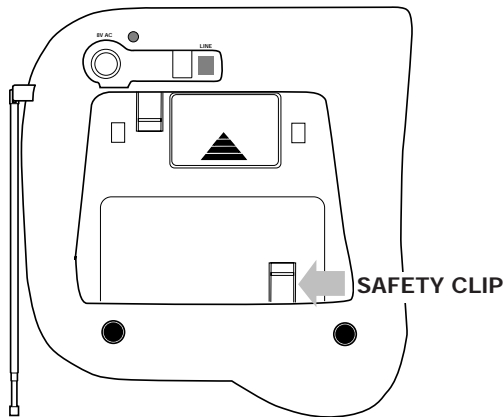

When attaching the stand make sure that it snaps securely into position over the clip.

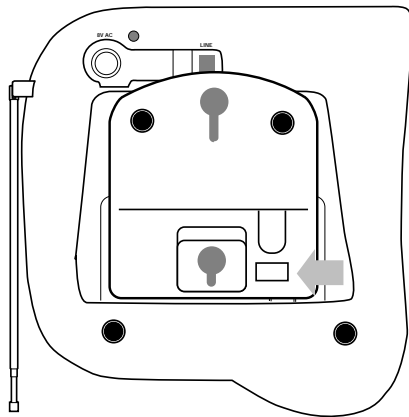

If you prefer to mount your Freestyle 1500 Plus on the wall, see page 10.

5 Plug the power cable into the base unit

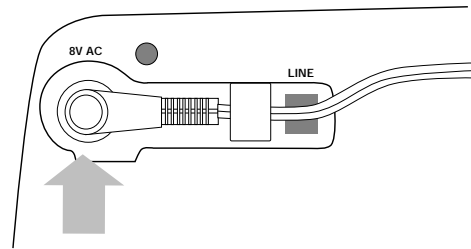

Plug the power cable into the socket located underneath the base unit. Thread the cable under the clip to make sure it cannot be pulled out accidentally.

Cautions

- 1 Do not attempt to use any power adaptor except the one supplied, as this may cause irreparable damage to your Freestyle 1500 Plus.
- 2 Your Freestyle 1500 Plus is mains powered and should not be installed in wet or damp conditions, for example in a bathroom. Also, the handset should not be left out in the rain.
- 3 There is a very slight chance that your phone could be damaged by severe electrical storms. We recommend that you unplug the unit from the mains during such storms.

6 Connect the 3-pin adaptor into a convenient mains socket

When the power is switched on, the red LED display on the base unit will come on and the digital voice prompt will give the status of the machine.

You will hear:

'Saturday 12.01 pm'

Your outgoing message is: 'Hello, your call cannot be taken at the moment, so please leave your message after the tone.'

These are the factory settings of your answering machine, and can be altered to suit your own requirements.

If you have a power failure or switch off your Freestyle 1500 Plus at the mains for any significant amount of time and you have not fitted back-up batteries (see page 6), your Freestyle 1500 Plus will revert to these settings.

7 Place the handset on the base unit

Your Freestyle 1500 Plus handset can be placed on the base either face up or face down.

The base unit's red **CHARGING** light comes on. The handset display shows **HSET 1**.

8 Leave the handset to charge for 24 hours

9 Extend the base unit telescopic aerial

Extend the base unit telescopic aerial on your Freestyle 1500 Plus (as shown below) to ensure the best possible signal and reception.

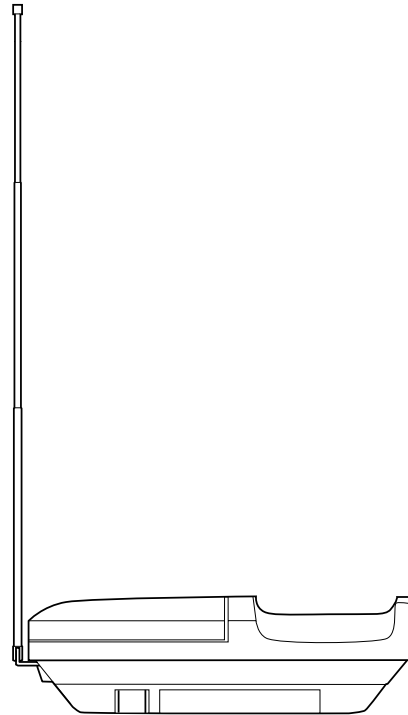

For best reception

For the best operating conditions, try to place the base unit away from large metal objects and other electrical appliances.

10 Plug into the phone socket

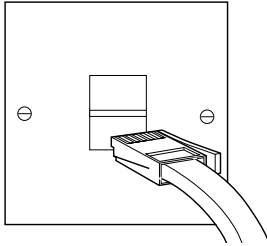

You can now use the phone, store numbers in the memory and change settings as desired.

The answering machine will work and is switched **ON**.

To turn the answering machine off, press the **ANSWER ON/OFF** button on the base unit. The voice announces 'Answer off'.

Using the inductive coupler



Your Freestyle 1500 Plus is fitted with an inductive coupler in its handset to improve sound quality for people using hearing aids. Switch your hearing aid to **T** and adjust the position of the handset until you obtain the best sound.

11 Wall-mounting your Freestyle 1500 Plus (optional)

Your Freestyle 1500 Plus can be wall-mounted by using the stand/bracket provided.

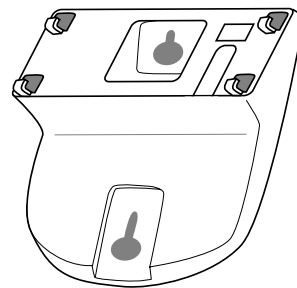

Use the stand/bracket as a template to mark where the screws should go into the wall.

Before you wall-mount your Freestyle 1500 Plus, check that:

- *the wall can support the weight of the base unit and handset;*
- *if you are replacing an existing wall-mounted phone, the hole positions already in the wall still line up with your Freestyle 1500 Plus stand|bracket.*
- *the position you choose leaves sufficient space around the mounting bracket so that the base unit (which is larger than the bracket) is clear of any obstruction on the wall, such as a shelf or cupboard. Room should be left so that the handset can be placed on charge without touching any obstructions.*
- *leave enough room for aerial to be extended when wall mounted.*

Setting up

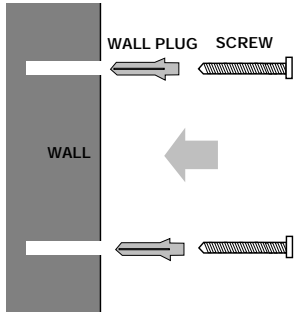

- Drill two holes for the screws and insert the wallplugs provided (if required).
- Put the screws into the wall, leaving about 5mm free to mount the stand/bracket.
- Hook the stand/bracket over the screw heads.

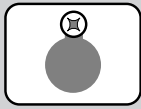

Attach the stand/bracket by hooking it over the screws protruding from the wall.

Clip the base unit onto the stand/bracket as shown below.

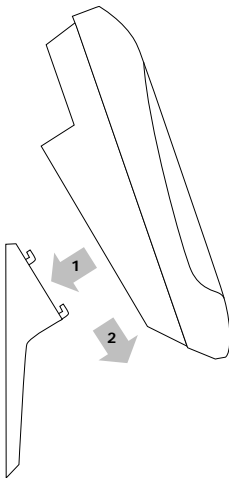

Your Freestyle 1500 Plus features a safety clip on the underside of the base which prevents the stand coming away from the unit accidentally.

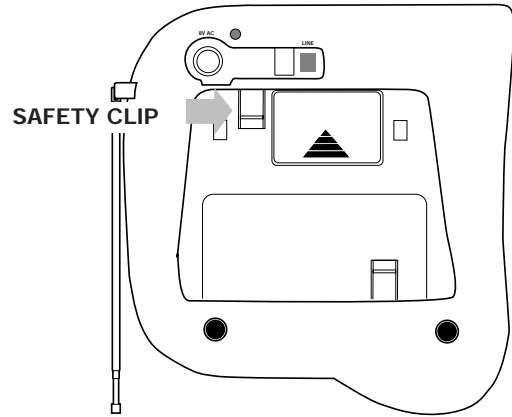

When attaching the stand make sure that it snaps securely into position over the clip.

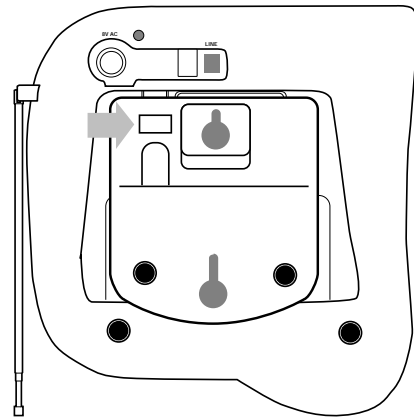

Your Freestyle 1500 Plus handset can be placed onto the base unit either face up or face down.

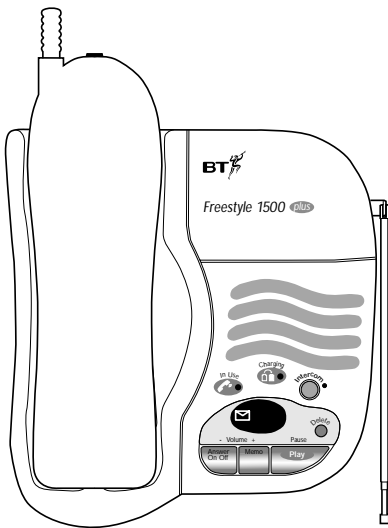
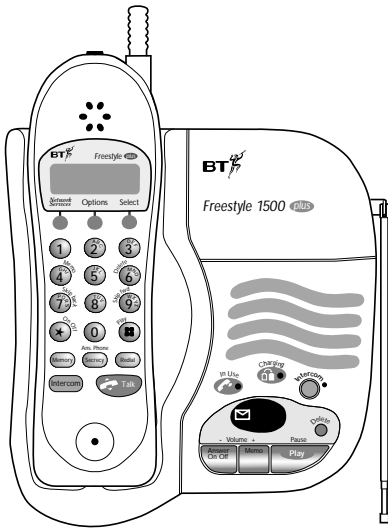

How to use your Freestyle 1500 Plus

Making and receiving calls

To make a call from the cordless handset



- Press the **TALK** button and listen for the dialling tone. The handset displays **TALK**.
- Dial the number you want. The display shows the last 12 digits dialled.

To end the call

- *Either* press the **TALK** button.
- *Or* replace the handset on the base unit.
- Display returns to **HSET 1**.

Handset range

The handset will operate up to 250 metres from the base unit (depending on local conditions).

If you go out of range while on a call, you will hear interference on the line, and the noise level will rise the further out of range you go. If you go too far out of range, your call will be cut off.

On-hook dialling

You can dial a telephone number while your Freestyle 1500 Plus handset is still on the base unit.

- Without lifting the handset, press the **TALK** button and dial the number you want.
- Display shows **TALK** and the dialled number. You will hear the ringing tone over the loudspeaker on the base unit.
- When your call is answered, lift the handset and continue your call as normal.

To receive a call

The base unit rings and shortly after the handset rings; the handset ring gradually increasing in volume.

The handset display shows **CALL**.

The red light at the top of the handset flashes.

To answer the call

- *Either* pick up the handset from the base and talk (you do not need to press the **TALK** button).
- *Or* if the handset is not on the base unit, press the **TALK** button and answer the call.

To end the call

- *Either* press the **TALK** button.
- *Or* replace the handset on the base unit.
- Display returns to **HSET 1**.

To redial the last number

To redial the last number:



- Press the **TALK** button.
- Press the **REDIAL** button. Display shows the number and your Freestyle 1500 Plus automatically redials the last number you called, saving time if the number was engaged.

To display the last number dialed:



- Lift the handset.
- Press the **MEMORY** button followed by the **REDIAL** button. The display will show the last number dialed. After a few seconds the handset will return to standby mode.

To clear the last number dialed:



- Lift the handset.
- Press the **MEMORY** button followed by the **★** button, display shows CLEAR.
- Press the **REDIAL** button, a tone will sound and the last number dialed is cleared, display returns to HSET 1.

Memory functions can not be used when the handset is charging.

Using the memory to store and dial numbers

Putting the most regular or important numbers you use in the memory enables you to dial them at the touch of just three buttons.

Your Freestyle 1500 Plus can store 10 phone numbers, each up to 20 digits long in the memory.

Use the directory label on the back of the handset to keep a record of numbers stored in the memory.

The directory label

Remove the handset battery lid and slide out the clear plastic label cover. Take out the label and write the appropriate name alongside each number you are storing. Replace the label for an easy reference. Using a pencil makes it easy to write in any changes to your directory.

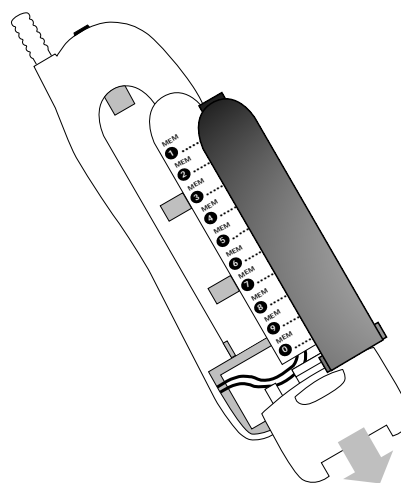

To store numbers in the memory



- Lift the handset.
- Display shows HSET 1.
- Press the **MEMORY** button and the display shows MEM.
- Press the number button (0-9) under which you wish to store the phone number.
The display shows the number, eg: 1- (this is the directory number).
- Dial the phone number you want to store.
- Press the **MEMORY** button again to store the number. You will hear a beep which confirms that the phone number has been stored.
- Display shows HSET 1.

To store up to nine other numbers, simply repeat these steps, remembering to use a different directory number (0-9) each time a number is stored.

To dial numbers stored in the memory

- Lift the handset.
- Display shows HSET 1.
- Press the **TALK** button and listen for the dial tone, display shows TALK.
- Press the **MEMORY** button. Display shows MEM TALK.
- Press the single digit under which the number you want is stored.
- The number is displayed and dialled automatically.
- End the call as normal.

To store numbers more than 20 digits long

To store very long numbers, you can run two or more stored numbers together.



- Lift the handset, display shows HSET 1.
- Press the **MEMORY** button and the directory number (0-9) under which you want the phone number stored.
- Dial in up to 20 digits; the display will show the numbers as you key them in.
- Press the **MEMORY** button again to store the number, display returns to HSET 1.
- To store the rest of the phone number, press the **MEMORY** button again and the next memory store number (between 0 and 9). Dial in the rest of the phone number. The display will show these numbers.
- Press the **MEMORY** button again to store the rest of the phone number, display returns to HSET 1.

To dial stored numbers more than 20 digits long

You can dial two or more stored numbers consecutively.



- Display shows HSET 1.
- Press the **TALK** button and listen for the dial tone; the display shows TALK.
- Press the **MEMORY** button and the memory store number you want.
- Press the **MEMORY** button again and the memory store number of the second part of the number you want.
- Display shows the numbers.

You can mix manual and memory dialling as required. For example, you can dial the area code 0181 380 from your Freestyle 1500 Plus memory, and then complete the number manually. Remember to let the memory number dial out completely before you dial manual digits.

To put a pause in the memory

*For such services as home banking, you may need to use the **PAUSE** function. Storing this in the memory is simple. Start programming in your number as shown previously. Where you want a pause, press the **OPTION** button. The display shows P. Continue the operation as normal.*

To delete a stored number

To remove a number from a memory store:

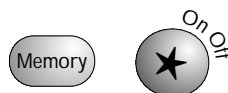

- Lift the handset.
- Press the **MEMORY** button.
- Press the **★** button; display shows CLEAR.
- Press the directory number button under which the number you wish to remove is stored.
- A beep will confirm that the number has been deleted.

To check the numbers you've stored in the memory



- Lift the handset.
- Display shows HSET 1.
- Press the **MEMORY** button.
- Press the single digit (0-9) under which the number you want to see is stored. The stored number is displayed.
- After a few seconds the display will go back to HSET 1.

Using the options button to change the telephone settings

The **OPTIONS** button allows you to change your Freestyle 1500 Plus telephone settings to suit your preferences.

Shown below are the settings as they appear in the display, along with the default settings.

Display		Default
HS RING ON/OFF	Turns handset ringer on or off.	ON
HI/LO/NO BASE RING	Selects the base ringer volume.	HI
TONE/PULSE	Changes the dialling mode to suit your exchange. Most exchanges require TONE.	TONE
RECALL TB/E	Selects timed break or earth recall (for use with switchboards).	TB

To switch the cordless handset ringer on or off

You must lift the cordless handset off the base unit in order to change any of the options settings.

- Press the **OPTIONS** button; the display shows **SET** followed by **HS RING ON**. This is your Freestyle 1500 Plus default setting.
- Press the **SELECT** button; the handset beeps and the display shows **HS RING OFF**.
- Press the **SELECT** button to move between on and off.
- To exit the menu and confirm all settings made, press the **OPTIONS** button repeatedly until the handset gives a long beep and the display returns to **HSET 1**.

To change the base unit ringer volume

- Press the **OPTIONS** button repeatedly until the display shows **HI BASE RING**. This is your Freestyle 1500 Plus default setting.
- Press the **SELECT** button to skip through the ringer volume options:
 - LO BASE RING** - base unit rings quietly.
 - NO BASE RING** - base unit does not ring.
 - HI BASE RING** - base unit rings loudly.
- When the required setting is shown in the display, press the **OPTIONS** key repeatedly until the handset gives a long beep, the setting is stored and the display returns to **HSET 1**.

To set the dial mode

The dial mode setting of your Freestyle 1500 Plus is set to **TONE** which works with all modernised exchanges. If you are on an old exchange, set the phone to **PULSE**.

*If you are in doubt as to which is the correct setting for you, contact BT free on 150.
(BT customers only)*

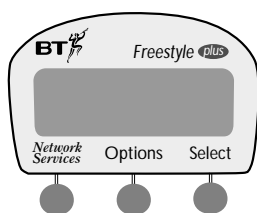

- While the display shows HSET 1, press the **OPTIONS** button repeatedly until **TONE** is displayed.
- Press the **SELECT** button and **PULSE** is displayed.
- Press the **SELECT** button to switch between tone and pulse.
- To exit the menu and confirm all settings made, press the **OPTIONS** button repeatedly until the handset gives a long beep and the display returns to HSET 1.

Please remember that the option shown on the display before pressing the **SELECT** button is the current setting. For example, if the display shows **HS RING ON**, it means that currently the handset ring is **ON** and pressing the **SELECT** button will turn it **OFF**.

If an incoming call arrives while you are part way through the above procedure, your Freestyle 1500 Plus will abandon the process to allow you to answer the call. Any changes you have made will be lost, and you will have to start again after you have finished the call.

To change the Recall mode for use with a switchboard

With switchboards, you will need to set the recall mode to **Time Break** or **Earth Recall**.

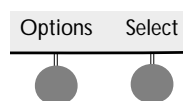

- While the display shows **HSET 1**, press the **OPTION** button repeatedly until display shows **RCL TB** or **RCL E**.
- Press the **SELECT** button to display the correct setting for your switchboard.
- To exit the menu and confirm all settings made, press the **OPTIONS** button again. The handset will give a long beep and the display will return to **HSET 1**.

To change the setting again, simply repeat these steps.

To stop your caller hearing a confidential remark

You can talk to someone else close by without the person on the other end of the line hearing what you say.

Ans. Phone

Secrecy

- When you are using the phone, press the **SECURITY** button and your caller cannot hear anything you say.
- Display shows **SECURITY** and the handset beeps every few seconds.
- Press the **SECURITY** button again to resume your phone conversation.

Call security

While you are using the phone, your Freestyle 1500 Plus automatically transmits security signals between the handset and base unit which prevents other cordless phones from using your line. You do not hear these code signals. For more information please refer to the Technical section on page 46.

Call clarity

Your Freestyle 1500 Plus has 8 channels and automatically selects the best option to give you the clearest reception.

Using the intercom

You can use the handset and base unit as an intercom, while the phone line stays free for incoming callers.

To call the base unit from the handset

At the handset:

Intercom

- Press the **INTERCOM** button.
- Display shows **INT**.
- Speak when the person at the base unit answers.
- To end the call, press the **INTERCOM** button.

At the base unit:



- The base unit rings and the intercom light flashes.
- To answer, press the **INTERCOM** button.
- To talk to the handset, speak near the base unit's in-built microphone. You will hear the person calling you via the speaker.
- To end the call, press the **INTERCOM** button.

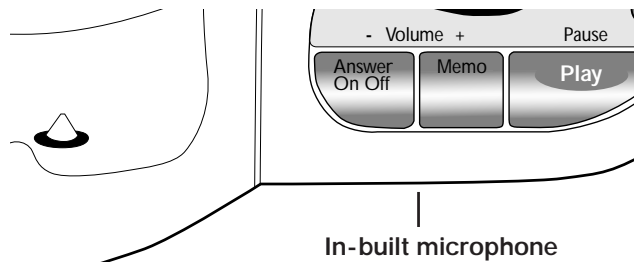

To call the handset from the base unit

At the base unit:



- Press the **INTERCOM** button.
- When the person at the handset answers, speak near the base unit's in-built microphone. You will hear the person you are calling via the in-built speaker.
- To end the call, press the **INTERCOM** button.

At the handset:

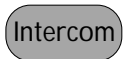

- Ringing indicator flashes and the handset rings; the display shows **INT CALL**.
- To answer, press the **INTERCOM** button.
- To end the call, press the handset **INTERCOM** button, or replace the handset on base unit; the display returns to **HSET 1**.

Using the answering machine

You can operate your Freestyle 1500 Plus answering machine from the handset, the base unit or from another telephone. You can also operate all functions while the handset is face up on the base.

Your Freestyle 1500 Plus can digitally record up to 14½ minutes of messages, with each incoming message lasting a maximum of 3 minutes.

If there is a silence lasting longer than 4 seconds during message recording, your Freestyle 1500 Plus will stop and automatically hang up.

Leave messages for family or colleagues by recording a memo on your Freestyle 1500 Plus. A memo can last for the length of time available in the memory - maximum of 14½ minutes.

You can set and record your own outgoing message direct from the handset.

Mains power failure/low back-up battery alert
In the event of a power failure, the date, time and outgoing message will revert to the original factory settings. A small flashing red dot on the base unit display will indicate this. To reset the power failure light, press any of the three buttons on the base unit. Your Freestyle 1500 Plus will not record messages during a power failure and the clock may need resetting. See 'Setting the date and time', page 22.
If a back-up battery is running low, the red dot will light up permanently to remind you to change it.

The base unit display

Status	Display
Answering machine switched off	(no display)
Answering machine switched on - no messages	0
Answering machine on with up to 9 messages received	1-9
More than 9 messages received	9 (flashing)
Message playing	P
Message paused	P (flashing)
Message recording (Incoming, Outgoing or Memo)	r
Memory full	F
Mains power failure indicator	. (red dot, flashing)
Low-battery indicator	. (red dot, on continuously)
When you ring in to pick up your messages	A

Operating the answering machine from the handset

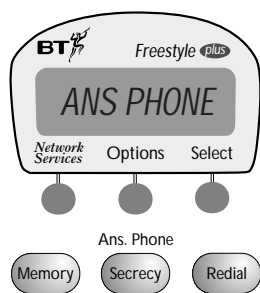

With the dual function buttons on the keypad, you can record memos, play back messages, skip/fast forward/rewind and delete messages, and turn the answering machine on and off – all from the handset.

Answering machine functions and menus are only available if the handset remains registered as handset 1.

Outgoing messages

When your Freestyle 1500 Plus is set to Answer and Record, callers will either hear your own personal message or, if you have not recorded one, they will hear the pre-recorded message: *'Hello, your call cannot be taken at the moment, so please leave your message after the tone.'*

If the recording capacity of 14½ minutes is used up, your Freestyle 1500 Plus automatically sets to Answer Only mode.

When your Freestyle 1500 Plus is set to Answer Only mode, callers will hear the fixed, pre-set message *'Hello, your call cannot be taken at the moment, so please call later.'* Your Freestyle 1500 Plus will then terminate the call.

Answering machine Options menu

Use this **OPTIONS** menu, in conjunction with the **ANS.PHONE/SECRECY** button, to adjust the answering machine settings to suit your needs.

SET DAY	sets the day of the week.
SET TIME	sets the hour and minute.
PLAY OGM	hear the pre-recorded message or your own outgoing message.
REC OGM	record your own outgoing message.
ANS DEL	sets the number of rings before the answering machine takes the call. You can select 2/3/4/5/6/7/8 or TIME SAVE. The factory setting is 6 RINGS.
ANS MODE	select between ANSWER AND RECORD or ANSWER ONLY (which gives callers a pre-recorded message without the opportunity to record their reply). The factory setting is ANSWER AND RECORD.
SET CODE	lets you set your own three-digit security code. The factory setting is 150.

*To check any of the above settings, press **ANS.PHONE/SECRECY** button, enter the **OPTIONS** menu and select the required feature, the display will show the current setting.*

*New settings will only be entered into the memory when you press the **SELECT** button.*

*When all settings have been made, press the **ANS.PHONE/SECRECY** button to exit the answering machine options menu or replace the handset on the base unit.*

To set the correct day

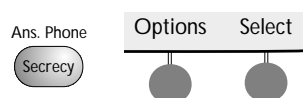

- Press the **ANS.PHONE/SECRECY** button on the handset. Display shows **ANS PHONE**.
- Press the **OPTION** button. Display shows **SET DAY**.
- Press the **SELECT** button to display the current setting.
- Press the **OPTION** button until the display shows the correct day of the week.
- Press the **SELECT** button to enter your setting.

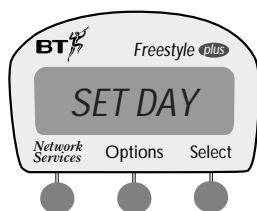

To set the correct time

- Press the **ANS.PHONE/SECRECY** button. Display shows **ANS PHONE**.
- Press the **OPTIONS** button until the display shows **SET TIME**.
- Press the **SELECT** button, the display will show the current time.

To change the display to the correct time, use the number buttons on the keypad. The Freestyle 1500 Plus uses the 24-hour clock. If you make a mistake when setting the time, simply keep on pressing the keypad number buttons to put in the correct setting.

- Press the **SELECT** button to enter the new setting. Press **ANS.PHONE/SECRECY** button to return to **HSET 1**.

To play the outgoing message

- Press the **ANS.PHONE/SECRECY** button. Display shows **ANS PHONE**.
- Press the **OPTIONS** button until the display shows **PLAY OGM**.
- Press the **SELECT** button. You will hear the outgoing message over the base unit loudspeaker and at the handset.
- The display will show **PLAY OGM** for about 18 seconds. During this time, pressing the **SELECT** button will replay the outgoing message. Press **ANS.PHONE/SECRECY** button to return to **HSET 1** or replace the handset on the base unit.

NOTE: When any messages refer to 'Press Square', you should press the # button. (also known as the hash button.)

To record an outgoing message

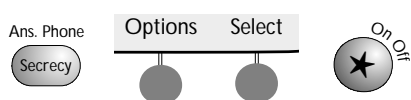

- Press the ANS.PHONE/SECURITY button. Display shows ANS PHONE.
- Press the OPTIONS button until the display shows REC OGM.
- Press the SELECT button. Voice prompt says: 'Please speak after the tone. To end recording, press square'.
- After the tone, speak clearly into the handset and leave your message.
- To end recording, press the PLAY/# button. You will hear the voice confirm, 'Your outgoing message is...' and your message will be played back to you.

The Display shows REC OGM again. You now have the option to re-record your message if you wish.

- Press the ANS.PHONE/SECURITY button to return to HSET 1.

Your outgoing message can only be recorded through the handset mouthpiece, which ensures maximum clarity.

To adjust the number of rings before the answering machine takes your call

The factory setting is 6 rings. You can adjust the setting for between 2-8 rings, or time saver. On the handset:

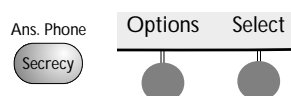

- Press the ANS.PHONE/SECURITY button. Display shows ANS PHONE.
- Press the OPTIONS button until the display shows ANS DELAY.
- Press the SELECT button.
- Press the OPTION button to scroll through and select the number of rings you want or the time-saver option.
- Press the SELECT button to enter your setting.
- Press the ANS.PHONE/SECURITY button to return to HSET 1.

The time-saver option

Time-saver is valuable if you plan to call in from another phone to pick up your messages.

It means your Freestyle 1500 Plus will automatically answer calls after just 2 rings if there are messages recorded and 6 rings if there are no messages recorded.

So when you call in to pick up your messages, if you hear more than 2 rings, you know there are no messages to pick up.

Using the answering machine

When setting the number of rings before your Freestyle 1500 Plus answering machine takes the call, please remember that callers normally expect to be answered within 10 seconds. Most will hang up after a maximum of 45 seconds.

To set your Freestyle 1500 Plus to answer calls within the normal period of 10 seconds, you should set the number of rings to 3. The factory setting of 6 rings equates to about 18 seconds.

A choice of answering modes

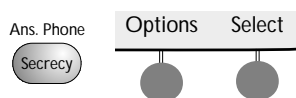

Your Freestyle 1500 Plus answering machine gives you the choice between Answer & Record or Answer Only modes.

The Answer & Record setting plays your outgoing message and allows callers to leave their message. There is a pre-recorded outgoing message which is: *'Hello, your call cannot be taken at the moment, so please leave your message after the tone'*. Alternatively, you can record your own message as described on page 23.

The Answer Only setting plays a fixed, pre-recorded message, which is: *'Hello, your call cannot be taken at the moment so please call later'*. It does not allow the caller to leave their own message.

It is not possible to record an alternative Answer Only message. It has been carefully worded so it will not reveal whether you are in or out - simply that you are not available to answer the phone.

To select Answer & Record or Answer Only mode

- Press the **ANS.PHONE/SECRECYP** button. Display shows **ANS PHONE**.
- Press the **OPTIONS** button until the display shows **ANS MODE**.
- Press the **SELECT** button.
- Press the **OPTIONS** button to select between **ANS ONLY** and **ANS + REC**.
- Press the **SELECT** button to confirm.
- Press the **ANS.PHONE/SECRECYP** button to return to HSET 1.

To set your security code

The security code lets you access your Freestyle 1500 Plus from any other phone. It also prevents other callers from listening to your messages. You can set a one, two or three digit code and choose to change it at any time. The factory set code is 150.

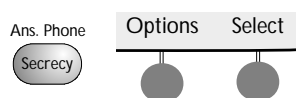

- Press the **ANS.PHONE/SECURITY** button. Display shows **ANS PHONE**.
- Press the **OPTIONS** button until the display shows **SET CODE**.
- Press the **SELECT** button.
- Press the **KEYPAD** number buttons to enter the one, two or three digit code you want.
- Press the **SELECT** button to enter your new code.
- Press the **ANS.PHONE/SECURITY** button to return to **HSET 1**.

When the maximum message length is reached, or the recording time available is full, callers will hear, 'Thank you for calling'. The Freestyle 1500 Plus will stop recording.

You can check your security code

- Press the **ANS.PHONE/SECURITY** button.
- Press the **OPTIONS** button to display **SET CODE**.
- Press the **SELECT** button and the code is displayed.
- Press the **ANS.PHONE/SECURITY** button to return to **HSET 1**.

To listen to your outgoing message

Your Freestyle 1500 Plus offers you a choice of outgoing messages.

Answer & Record mode pre-recorded message or your own message

Answer Only mode Pre-recorded message only

Pre-recorded message or your own Answer & Record message:

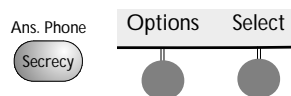

- Set the Freestyle 1500 Plus to Answer & Record mode (see page 24).
- Press the **ANS.PHONE/SECURITY** button.
- Press the **OPTIONS** button to display **PLAY OGM**.
- Press the **SELECT** button and the outgoing message will be played.
- To stop the playback, press the **ANS.PHONE/SECURITY** button.

Pre-recorded Answer Only message:

- Set the Freestyle 1500 Plus to Answer Only mode (see page 24).
- Press the **ANS.PHONE/SECURITY** button.
- Press the **OPTIONS** button to display **PLAY OGM**.
- Press the **SELECT** button and the outgoing message will be played.
- To stop the playback, press the **ANS.PHONE/SECURITY** button.

Using the answering machine

To switch the answering machine on or off

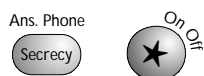

- Press the **ANS.PHONE/SECURITY** button. Display shows **ANS PHONE**. Base unit display shows **0**.
- Press the **ON/OFF★** button to display the current setting **ANS ON** or **ANS OFF**.
- Press the **ON/OFF★** button again to change between **ANS ON** and **ANS OFF**.
- After a few seconds the handset display returns to **ANS.PHONE**.
- Press the **ANS.PHONE/SECURITY** button to return to **HSET 1**.
- In the Answer On mode the base unit shows '0' or the number of messages saved.
- In the Answer Off mode the base unit displays -.

To record a memo using the handset
Your Freestyle 1500 Plus lets you record a memo which can be played back later.

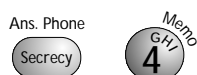

- Press the **ANS.PHONE/SECURITY** button. Display shows **ANS PHONE**.
- Press the **MEMO 4** button. You will hear the voice say, *'Please speak after the tone. To end the recording, press square'*.
- Speak after the tone. When you have finished, press the **PLAY/#** button.
- Press the **ANS.PHONE/SECURITY** button to return to **HSET 1**.

To play back your messages



- Press the **ANS.PHONE/SECURITY** button. Display shows **ANS PHONE**.
- Press the **PLAY/#** button, display shows **PLAY**.

The voice states the number of messages you have. Before each message is played, the voice also states which message it is, such as 'Message 1'. After the message has been played, the voice will announce the day and time it was received. During playback the base unit displays "P".

*Press the ★ button during message playback, and Freestyle 1500 Plus display returns to **ANS.PHONE** mode for you to use another function.*

Freestyle 1500 Plus logs each message
After each message is played back, the voice prompt states the day and time it was received.

To pause a message

While playing your message:

- Press the **PLAY/#** button again. Display shows **PAUSED**.
- To release the pause, press the **PLAY/#** button a third time.
- If playback is paused for more than 60 seconds the handset returns to **HSET 1** and the base returns to standby mode.

To skip messages



While playing your messages:

- Press the SKIP/7 or SKIP/9 buttons to skip backwards or forwards.

Pressing the SKIP/7 or SKIP/9 buttons when messages are being played from the base has no effect.

To exit from the Answering machine Options menu at any time, press the ANS.PHONE/SECURITY button.

To delete messages



Freestyle 1500 Plus lets you delete any individual message, in any order. The other messages will be kept in the chronological order they were recorded in.

- During playback, press the DELETE 6 button. The voice confirms the individual message is deleted.
- To clear all messages, press DELETE 6 after the last message has been played back. The voice confirms that all messages have been deleted.

Pressing the DELETE button during the Message Number announcement will have no effect.

Operating the answering machine from the base unit

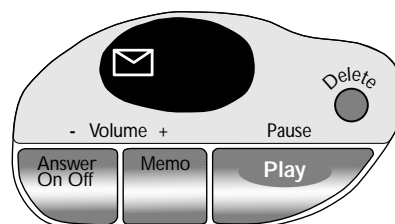

To switch the answering machine on/off
Press the ANSWER ON/OFF button. The voice prompt will give the status of the machine, for example 'Answer On' or 'Answer Off'.

- When the answering machine is off, the display shows '-'.
- When the answering machine is on, the display shows 0 (or the number of messages recorded).

To play back messages



- Press the **PLAY** button. The voice will tell you how many messages you have and the display shows *P*.

Before each message is played, the voice also states which message it is, such as 'Message 1'. After the message has been played, the voice will announce the day and time it was received.

- After the last message, you will hear the voice say 'End of messages. To delete all messages, press delete'. You have about 8 seconds to press the **DELETE** button to delete all messages.
- The machine will then return to the answer mode selected before message playback.

All messages are saved automatically until you delete them.

Remember to delete unwanted messages.

To pause a message

- During playback, press the **PLAY** button again. Display on base shows 'P' flashing.
- To release the pause, press the **PLAY** button a third time.
- To cancel playback, press the **PLAY** button to pause, followed by the **ON/OFF** button.
- To delete the message paused, press the **DELETE** button.

To adjust the loudspeaker volume

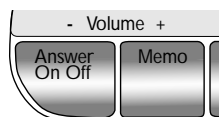

- During playback, press the **MEMO** button to increase the volume or press the **ANSWER ON/OFF** button to decrease the volume.

The lowest setting is silence. If you leave Freestyle 1500 Plus at this level, playback automatically resets the volume to the mid-level.

If the base unit is busy, for example playing back messages, the handset will not be able to access the menus or the telephone line.

To record a memo



Leave messages for family or colleagues by recording memos on your Freestyle 1500 Plus. A memo can last for the length of time available on the memory – maximum of 14½ minutes.

- Press the MEMO button and keep it held down. You will hear the voice say, *'Please speak after the tone'* followed by a beep.
- Start your memo message. The display on the base unit shows 'r'.
- Speak clearly, keeping within 20 cm of the base unit's microphone.
- When you have finished talking, release the MEMO button. You will hear a beep, and the display will show that another message has been recorded.
- To play back your memo, press the PLAY button. Base unit display shows "P".

You can leave any number of memos. They can be played back in the same way as Incoming Messages.

To delete messages

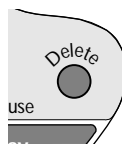

Freestyle 1500 Plus lets you delete any individual message, in any order. The other messages will be kept in the chronological order they were recorded in.

- During playback, press the DELETE button. The voice confirms that the individual message is deleted.
- To clear all messages, press DELETE after the last message has been played back.

Operating the answering machine from another telephone

You can call your Freestyle 1500 Plus from another phone to listen to your messages and operate a number of its features.

Carry the Freestyle 1500 Plus Reminder Card in your wallet or purse. It is your quick guide to operating your answering machine from another telephone.

To switch on the answering machine from another phone

If you have left your Freestyle 1500 Plus switched off, simply phone your number and let it ring 20 times. Your Freestyle 1500 Plus will then automatically answer the call and stay switched on.

Please note: when you switch the answering machine on in this way, it will be in the answer mode you last set, such as Answer & Record or Answer Only.

Remote operating menu

Press keypad button	Action
1	Hear menu
2	Play/Pause
4	Skip message backwards
5	Delete (deletes the message being played or, at the end of playback, deletes all messages)
6	Skip message forwards
7	Switch to Answer & Record or Answer Only
8	Play outgoing message
9	Record a new outgoing message
0	Alternately turns machine on and off

To listen to your messages

When your Freestyle 1500 Plus answers, press the ★ button on the phone you are calling from. The voice says, '*Please enter your security code*'.

Press the keypad to enter the one, two or three digit code you have set (see page 25). If you make an error, press the ★ button and re-try.

If your security code is not correct

If you do not enter enough digits within 8 seconds, the voice will say again, *'Please enter your security code'*. If the wrong code is entered a second time, the voice says, *'Error, thank you for calling'* and the machine will hang up.

If you have messages: You will hear the voice say, *'You have "X" messages'* and the messages are played.

When all messages have been played, the unit will announce *'End of Messages'* before offering options 2, 5, 7, 8, 9 and 1 from the remote operating menu.

If you have no messages: you will hear, *'You have no messages'*.

Then you are given the opportunity to select options 7, 8, 9 and 1 from the remote operating menu opposite. If you do not press any button within 8 seconds, your Freestyle 1500 Plus announces, *'Thank you for calling'* and hangs up. The answering machine will re-set to ANSWER and RECORD mode.

Save time when leaving a message on your Freestyle 1500 Plus

When calling in from another telephone, pressing the # button will save you having to hear your outgoing message. You will simply hear a beep.

To replay your messages

When you hear the menu prompt, press the 2 button on the keypad. Your messages will be replayed in chronological order.

To pause a message, press the 2 button again. To continue hearing your message, press the 2 button a third time.

To skip messages

- To move on to the next message press the 6 button on the keypad.
- To restart the message currently playing press the 4 button on the keypad.
- To play the previous message press the 4 button, to restart the current message, then press the 4 button again.

To delete messages

- To delete individual messages, press the 5 button on the keypad during the message. The voice announces, *'Message deleted'*.
- To delete all messages, press the 5 button after all messages have been played back. The voice will say, *'Messages deleted, for menu press 1'*.

To switch between Answer & Record and Answer Only

- Press the 7 button on the keypad. You will hear the voice announce *'Set to Answer & Record'* or *'Answer Only'*. To change the setting, press the 7 button again.

*Using the
answering machine*

To check your outgoing message

- Press the 8 button on the keypad. You will hear your outgoing message.

To record a new outgoing message

- Press 9 on the keypad. The voice will say, *'Please speak after the tone. To end recording, press 9'*.
- When you have finished recording your new message, press the 9 button. Your new outgoing message is played back.

To return to the main menu at any time during remote operation, press 1.

When calling in from another telephone, your Freestyle 1500 Plus allows you about 8 seconds to take any action before ending your call.

To switch your answering machine off

- Press the 0 button on the keypad.
- To switch it back on, press the 0 button again.

When the answering machine is set to off, the Freestyle 1500 Plus will answer the call after 20 rings and the answering machine will be set on.

Additional features

These pages show you how to make the most of your Freestyle 1500 Plus.

In talk mode

In talk mode the following features are available:

- Call transfer
- Base unit listen on/off
- Channel change
- Recall

When accessing these features, the last-used option will be displayed first.

The option you see on the display before pressing the SELECT button is the one you will set. For example, if the display shows LISTEN ON, it means that currently the speaker is OFF, and pressing the SELECT button will turn it ON.

To select call transfer

Call transfer is available only if you have more than one handset. You can buy and use up to three extra handsets displaying the Homepoint Plus logo with your Freestyle 1500 Plus.

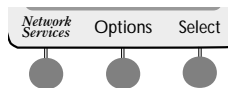

- While engaged on a call, press the **OPTIONS** button repeatedly until the display shows **TRANSFER**.

- Press the **SELECT** button followed by the number of the handset you wish to transfer the call to.
- Your handset will now return to standby mode; display shows your handset number.
- The handset dialled will ring and the call can now be taken.
- If the call is not answered, your handset will ring and you must answer the call as normal.
- Press the **TALK** button to answer the call and return to the caller.

If the call is not answered after about 20 seconds, it will be ended automatically.

To set the base unit listen on/off

During a call, you may want someone at the base unit to listen in on your conversation.

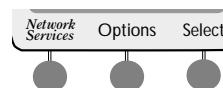

- To switch on the base unit speaker, press the **OPTIONS** button repeatedly until the display shows **LISTEN ON**.
- Press the **SELECT** button and the base unit speaker is switched on; the display clears.
- At the end of the call, your Freestyle 1500 Plus resets the base unit speaker to its default setting, **OFF**.

Additional features

- To turn the base speaker off while still engaged on a call, press the **OPTIONS** button repeatedly until the display shows **LISTEN OFF**.
- Press the **SELECT** button and the base unit speaker is switched off.

To change channel

While engaged on a call, or after pressing the **TALK** button to select talk mode, you can instruct your Freestyle 1500 Plus to search through its channel frequencies and select the best one.

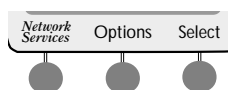

- Press the **OPTIONS** button until the display shows **CHANNEL**.
- Press the **SELECT** button; the display clears temporarily and your Freestyle 1500 Plus cycles through the channels and selects the one which currently has the least interference.

To dial Recall

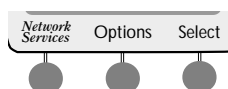

If you have an ordinary telephone extension to a PBX, you would normally use the **RECALL** button to put a call on hold and transfer it to another extension. If your Freestyle 1500 Plus is connected as an extension to a PBX, you can do the same thing from the **Options** menu, during a call.

- Press the **OPTIONS** button until the display shows **RECALL**.
- Press the **SELECT** button; the display shows **r**.
- Dial the extension number to which you wish to transfer the call, as normal.

Call screening and intercept

When the answering machine is switched on, you can monitor incoming calls from the handset and choose whether to take the call personally or let your Freestyle 1500 Plus take a message.



- When the phone rings, the handset display shows **CALL**.
- When your Freestyle 1500 Plus is playing its outgoing message, the handset display shows **OGM PLAY**. When it is recording the incoming message the handset display shows **RECORD**.
- During the call press the **ANS.PHONE/SECRECY** button on the handset, display shows **SCREEN**. You will now be able to hear the caller leaving their message.
- If you want to intercept the call, press the **TALK** button, the answering machine will stop recording and you will be able to talk to the caller. At the end of the call, the answering machine will switch back on and the previously recorded part of the call will be saved.

Using Network Services

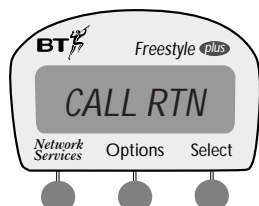

Network Services are available to anyone connected to a modern digital exchange. With the exception of Call Return, each service carries a small quarterly charge.

Once the TALK button has been pressed, you can use the Network Services button on the handset to access:

Call Return
Call Waiting
Call Divert

To use Call Return

Free service, which gives you the number of your last caller.

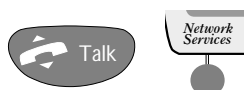

- Press the TALK button.
- Press the NETWORK SERVICES button to display CALL RTN.
- Press the SELECT button. You should hear an announcement from the exchange telling you the phone number and time of the last call. If the number has been withheld, you will hear 'no number is stored'

When making a call, if you want to withhold your number from Call Return, dial 141 before calling. You need to do this even if your number is ex-directory.

To use Call Waiting

When your line is engaged, and another person tries to call you, Call Waiting warns you of the second caller and lets you answer it by putting the first call on hold. If you want, you can even switch between calls.

To indicate a second call, you will hear a series of beeps which are repeated every few seconds.

To answer the second call:

- Tell your first caller that you have another call.
- Press the NETWORK SERVICES button to display CALL WTG.
- Press the SELECT button to put the first caller on hold and answer the second call.
- To put the second caller on hold and return to the first, press the NETWORK SERVICES button to display CALL WTG and press SELECT button.

You can switch between both callers as often as you wish.

When the call you are on is ended, your handset will ring. Press the TALK button and you are automatically returned to the other call.

To use Call Divert

You can transfer incoming calls to any other number where you can be reached.

To divert incoming calls:

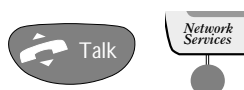

- Press the TALK button
- Press the NETWORK SERVICES BUTTON to display DIVERT CALL.
- Press the SELECT button and listen for a message from the exchange. Follow the simple instructions to set up your call divert.
- At the end of the message, press the TALK button again. All your incoming calls will now be diverted to the number you have specified.

To cancel Call Divert



- Press the TALK button.
- Press the NETWORK SERVICES BUTTON to display DIVERT CALL.
- Press the SELECT button and listen for the cancellation message from the exchange.
- Follow the simple instructions to cancel your call divert.
- At the end of the message, press the TALK button again.

Advanced Network Services

There are other services you can enjoy if your Freestyle 1500 Plus is connected to a modern digital exchange.

Three-Way Calling ideal for business or family matters, three-way calling lets you speak to two other callers at the same time.

Reminder Call turns your Freestyle 1500 Plus into a 24-hour alarm clock.

Charge Advice instantly tells you the exact cost of the call you have just finished.

These and many other useful services are available via a modern exchange.

For more information about advanced Network Services, call BT on **Freefone 0800 800 152**. If you are not on the BT Network, please ask your telecommunications supplier for information on their services.

To connect to a switchboard

Your Freestyle 1500 Plus allows you to use the facilities available on a modern switchboard (it is only approved for use on compatible switchboards).

For a list of suitable switchboards, phone BT on **Freefone 0800 800 152**.

However, even with a compatible switchboard, your Freestyle 1500 Plus cannot be guaranteed to operate correctly under every possible condition of connection. If you have any difficulties, contact your communications manager for advice.

If you are a BT customer connected to a digital exchange, you can subscribe to a range of BT's Select Services. If you wish to subscribe to any of these services, contact us on **Freefone 0800 800 150** for residential customers or **Freefone 0800 800 152** for business customers (9am to 5pm, Monday to Friday).

If you are not a BT customer, please contact your network provider for information about their network based services.

Connecting to a switchboard

If you are connecting your Freestyle 1500 Plus to a switchboard or PBX, the DIAL MODE setting may need changing. If in doubt, contact your switchboard supplier or communications manager. Your Freestyle 1500 Plus is approved for use with compatible switchboards.

*If you have any difficulties, phone BT on **Freefone 0800 800 154**.*

Confirmation of selected options

*To confirm any change made under the OPTIONS menu, press the **OPTIONS** button repeatedly until the handset gives a long beep and the display returns to HSET 1.*

Freestyle Plus Additional Handsets

The Homepoint Plus logo (shown below) on your Freestyle 1500 Plus means that you can buy and use up to three extra handsets displaying the same logo to extend your phone system whenever you want, without needing to install extension sockets at each location.

Each additional handset is supplied with its own charger and user instructions, however the following information will tell you how to register and use an additional handset with your Freestyle 1500 Plus.



Homepoint Plus

You will not be able to make or receive calls using additional handsets until they have been registered using your Freestyle 1500 Plus base unit.

Please note

Only Freestyle Plus Additional Handsets (Item Code: 871156) can be used with this product. If buying additional handsets for your Freestyle 1500 Plus, please ensure you purchase the correct type.

Registering your Plus handset

You must register each additional handset before it can be used with your Freestyle 1500 Plus. Make sure that each additional handset is registered with a different number so it can be identified from other handsets.

Answering machine functions and menus are only available if the primary handset remains registered as handset 1.

To register an additional Plus handset

Additional handsets should be registered within 30cm of your Freestyle 1500 Plus base unit.

At the handset



- Lift the additional handset to be registered.
- Press and release the **MEMORY** button, the handset will beep immediately.
- Press and hold the **SECURITY** button until the handset beeps again.
- Enter the additional handset number (2, 3 or 4) using the handset keypad. The handset will beep.

At the base unit



- Within 2 seconds press and hold down your Freestyle 1500 Plus's base unit **INTERCOM** button until you hear a long beep.

*Be sure to press and hold the **INTERCOM** button on your Freestyle 1500 Plus base unit and not the additional handset.*

- Release the **INTERCOM** button on the base unit, both the additional handset and your Freestyle base unit will sound a confirmation beep. If you do not hear a beep from both units, then programming is unsuccessful. Wait 10 seconds, then repeat the procedure.

To check that your additional handset is registered correctly

Check additional handsets are registered within range of your Freestyle 1500 Plus base unit.

- Lift the additional handset.
- Press the **TALK** button.
- Listen for the dial tone.

If you do not hear a dial tone, your additional handset is either out of range of your Freestyle 1500 Plus or it has not been registered properly, or you may have purchased the wrong handset -

check that the handset you have is item code 871156. This can be found on the side of your giftbox.

Re-register your additional handset by repeating the procedure on page 38.

Basic use of Freestyle Plus Additional Handsets

*Like all cordless phones, the Freestyle Plus Additional Handset must be charged for **24 hours**.*

With the exception of the functions listed below, basic operation of Additional Plus Handsets is the same as that of your Freestyle 1500 Plus handset. The additional handset is not able to control the answering machine functions.

To make and receive calls



- When making calls the **IN USE** light on the additional handset will come on.
- When you receive an incoming call both your Freestyle 1500 Plus and additional handset will ring and the **IN USE** light will flash.
- To answer a call pick up the additional handset and press the **TALK** button.

To put a pause in the memory



For such services as home banking, you may need to use the **PAUSE** function. Storing this in the memory is simple. Start programming in your number. Where you want a pause, press the **PAUSE** button. Continue the operation as normal.

To transfer a call between handsets



- During a call press the **TRANSFER** button followed by the registration number of the handset you want to transfer the call to.
- The handset you are calling from returns to standby mode.
- When the handset you have called rings, press the **TALK** button to receive the transferred call.

If the handset you have called is not answered, the call is re-directed back to you. If the call is still not answered it will be cut off.

NOTE: *Memory functions on additional handsets are independent and in addition to the standard handset memories*

Help *If you have any problems using your Freestyle 1500 Plus, look here first for the most common solutions.*

Emergency calls

The emergency services can be contacted on this phone by dialling 999 or 112.

Your Freestyle 1500 Plus is a radio system and is mains powered. As such, there are certain situations where you may find you cannot make an emergency call from the handset.

These are:

- If there is too much interference from sources including other cordless phones, radio station transmitters, CB radios and so on.
- If the handset battery fails.
- If there is a power cut and the base unit has no back-up battery fitted.

Low-battery indicator on the handset
When the handset battery runs low, the display shows BATT and the handset beeps. After a further 30 seconds, any phone or intercom call currently being made will be cut off. To recharge the battery, leave the handset charging on the base for at least 24 hours.

No dialling tone

Is the base unit plugged in and switched on at the mains?

Is the mains lead disconnected at the base unit?

The cordless handset may need recharging. Place it on the base or, if necessary replace the rechargeable battery (available from your BT stockist).

Make sure your telephone line cord is plugged into the phone socket.

You may be out of range of the base unit. Try again nearer the base.

Is the base unit telescopic aerial fully extended? This will ensure you get the maximum possible range.

You dial and nothing happens

Before dialling you should check to ensure you can hear the dial tone.

You may be out of range of the base unit. Try again nearer the base.

Are you connected to an old-style exchange?
If so, you will need to change the phone's dialling mode from Tone to Pulse.
To check what type of exchange you are on, call BT on *Freefone 0800 800 150*.

To check your handset is within range of your Freestyle 1500 Plus base unit

- While the display shows HSET 1, press 0.
- If your handset is in range, the display will show TEST and then IN RANGE. The display will then return to HSET 1.
- If your handset is out of range, the display will show TEST and then return to HSET 1 after beeping.

Handset and base unit do not ring
Have you turned the ringer off? (See page 16.)

Are there too many other phones and fax machines plugged in which could be overloading the sockets? (See Ringer Equivalence Number, page 47.)

Noise or interference from the handset
You may be at the extreme range of the handset. Try moving nearer the base.

The base or handset may be too close to other electrical equipment and metal objects. (Occasionally, overhead power lines can cause interference when you use the handset outdoors. Try again nearer the base.)

If your Freestyle 1500 Plus picks up conversations from other cordless phones, you can change channels during a call (see page 34).

Handset seems to be 'dead'

Check that the mains power is switched on at the base. Make sure the handset batteries are fully charged.

Check that the base unit telescopic aerial is fully extended and is away from other electrical appliances or large metal objects such as a radiator, shelf unit or garage door.

Try resetting the phone by unplugging it from the mains and removing the handset and base back-up batteries for a few seconds.
Now reconnect the batteries, plug in the base, replace the handset on the base and try again.

Installing handset batteries and recharging

When fully charged and in good condition, the handset batteries will last for up to 5 hours continuous use in talk mode or 48 hours in standby mode. If the batteries are running low, the handset will display a flashing BATT warning message.

If you are on a call, the handset will give a series of beeps and the BATT warning message will remain on the display. You will have about 30 seconds before the call is cut off.

Normally, replacing the handset on the base unit to recharge overnight will keep it fully operative for normal everyday use.

If, in time, you find that the batteries are not holding sufficient charge, they should be replaced. New batteries are available from BT phone shops or your supplier.

To change the handset batteries

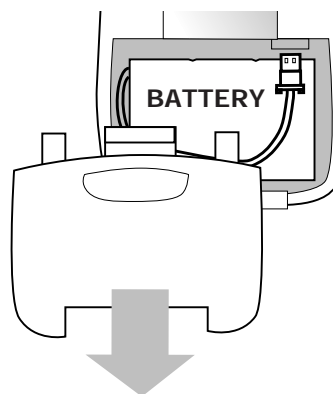

- Slide open the battery cover on the back of the handset and remove the old battery.
- Place the new battery in the compartment; remember to plug in the battery connector
- Replace the battery cover and place the handset on the base unit.
- Leave the handset to re-charge for 24 hours.

Battery saving tips

To extend the life of your handset batteries, it is a good idea to take the handset off the base for around two hours every day or let the handset run down completely once every six months.

Battery charging contacts

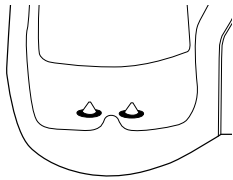

Base unit contacts

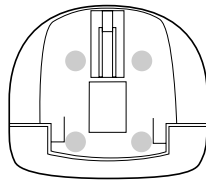

Handset contacts

Check that the charging contacts on the base unit and the handset are kept clean. If they become tarnished or dirty, your Freestyle 1500 Plus may not recharge efficiently. Clean the contacts by wiping them with a dry cloth.

Extended periods of non-use

If you are not going to use your Freestyle 1500 Plus for a long period of time (for example if you are going on holiday), we recommend that you:

- disconnect the base unit from both mains supply and phone line;
- disconnect and remove the back-up battery from the base unit;
- recharge the handset batteries for 24 hours when reconnecting.

Cleaning

Simply clean the handset and base unit with a damp cloth or an antistatic wipe. Avoid using household sprays and cleansers as they can damage your Freestyle 1500 Plus.

Protecting your Freestyle 1500 Plus

Most electrical appliances are affected by the electrical activity of thunderstorms. Cordless phones are particularly susceptible to damage. To protect your Freestyle 1500 Plus, it is advisable to unplug it from the mains and BT socket during thunderstorms.

Answering machine help

Display does not light up

Check that your Freestyle 1500 Plus is correctly connected to the mains power socket and that the power is switched on. Check that the power cable is inserted into the socket on the back of the machine.

Message does not record

If you are recording a memo through the base unit microphone, speak clearly and towards the base microphone. Recording your message through the handset will ensure a good quality recording (see page 23 & 26).

Is the 14½ minute memory full? If so, the display will show 'F' and the Freestyle 1500 Plus will not record. You will need to delete messages.

Cannot hear the call being answered

When the answering machine is answering a call, you can hear the message from the base, providing the base volume is not set to silence. If you can't hear the call then press the memo button to increase the volume.

Incoming message does not record

Make sure your Freestyle 1500 Plus is set to Answer-on mode and that the memory is not full. When the memory is full, the display will show 'F'.

Caller may be speaking too quietly or has a bad connection.

You cannot contact or operate your Freestyle 1500 Plus from another phone

Make sure that the phone you are using has a *Touchtone*[™] keypad.

When entering your security code, make sure you allow enough time between digits for your Freestyle 1500 Plus to recognise each one.

To reset

If you encounter a problem and your Freestyle 1500 Plus will not respond to any button presses, remove the back-up battery (if fitted) and turn off the mains power for at least 10 seconds. Turning the power off will reset your Freestyle 1500 Plus to Answer-on mode. Any messages recorded will be lost when resetting your Freestyle 1500 Plus.

Further assistance

Should you need further assistance, call the Customer Helpline on **0345 697330** between 9.00am and 5.30pm, Monday to Friday, where trained staff are ready to help. Please ensure that you have the serial number of your Freestyle 1500 Plus (see page 4).

Please note that engineering visits are chargeable. In the unlikely event of a problem occurring during the warranty period, please return to your point of purchase.

Service

Outside guarantee

If your Freestyle 1500 Plus is more than 12 months old, you will need to telephone one of the following numbers between 9.00am and 4.30pm, Monday to Friday, **01737 789300** or **01672 564444**. Alternatively you can take your Freestyle 1500 Plus to your nearest BT shop. They will forward it for repair (there will be a postage charge for this).

Please note that the repair of your product outside guarantee is a chargeable service.

Some suppliers offer extended warranty schemes for cover outside the initial 12 month period. Please ask them for details.

Technical information

Official approval

Freestyle 1500 Plus is tested and approved for connection to the BT network, provided that it is used in accordance with the guidelines in this user guide.

You may connect it:

- to direct exchange lines;
- to extensions with new plug and socket arrangements provided with these direct exchange lines;
- to compatible switchboards.

This phone is designed for UK use only. Using it abroad may violate local radio laws.

Approval for use

This apparatus has been approved for use with the following facilities:

Simple telephone.
Cordless telephone.
Time break recall/earth loop recall.
Automatic storage of last number dialled.
Loop disconnect and MF signalling.
Microphone secrecy.
PABX providing secondary proceed indication.
Memory redial of up to ten numbers.
Mixed mode dialling.
Operation in absence of proceed indication.
Network Services.

Any other usage will invalidate the approval of the apparatus if, as a result, it then ceases to conform to the standards against which approval was granted.

The base unit is intended for use when powered from the mains adaptor supplied, which has a rating of 8V at 400 mA and which conforms to BS415. Any other usage will invalidate the approval given to this apparatus if, as a result, it ceases to comply with BS415.

Call Security

Your Freestyle 1500 Plus has its own digital security code that prevents other cordless phone owners from using your phone line. This ensures that you are charged only for calls using your phone.

However, all approved cordless phones use radio to communicate between the base and cordless handsets. It is therefore possible that your conversation could be overheard by other people on their cordless phones, or on ordinary radios that use the same radio frequencies.

As the problem applies equally to all similar cordless phones currently available in the UK, call privacy cannot be guaranteed. However, the security coding prevents unauthorised use of your line by third parties.

Transmission frequencies

This cordless telephone has been designed to operate on radio frequencies which have been assigned to the exclusive use of cordless telephones. As the use of cordless telephones becomes more widespread, users may experience a reduction in the quality of service obtained from this apparatus.

Transmission frequencies of available channels:

Channel	Base Unit (MHz)	Portable Unit (MHz)
1	31.0375	39.9375
2	31.0625	39.9625
3	31.0875	39.9875
4	31.1125	40.0125
5	31.1375	40.0375
6	31.1625	40.0625
7	31.1875	40.0875
8	31.2125	40.1125

Handset batteries

When fully charged and in good condition, the handset battery will last for up to 5 hours in Talk mode or 48 hours in Standby mode.

Ringer Equivalence Number (REN)

Although you may have any number of sockets, it is important to limit the number of telephones and other items of apparatus connected to the line by those sockets, to ensure that each telephone will ring.

Every telephone or item of apparatus has a Ringer Equivalence Number (REN). In most cases a standard line should provide enough current for two or more telephones or items of apparatus if the RENs add up to no more than 4.

Freestyle 1500 Plus has a REN of 1. Any telephone provided by BT may be assumed to have a REN of 1 unless otherwise stated on the base. Even where the number of telephones has been limited, there is no guarantee that the different types of telephone on the same line will ring.

Index

Additional features	33	Homepoint Plus	4
Additional Plus handsets	38	Inductive coupler	9
Aerial, base unit	8	Intercom	18
Aerial, handset	6	Last number redial	13
Answering machine	20	Loudspeaker volume	28
Answering machine help	44	Low handset battery warning	41
Answer mode		Memo	26, 29
Answer only	24	Memory	
Answer & record	24	checking	15
At a glance	1	dialling	14
Base unit listen on/off	33	deleting	15
Battery, base unit	6	storing numbers	14
Battery, handset	43	Messages	
Call divert	36	playing	26, 28
Call return	35	deleting	27, 29
Call screening	34	recording	23
Call security	18	Network Services	35
Call transfer	33, 40	On-hook dialling	12
Call waiting	35	Options menu	
Channel change	34	answering machine	21
Charging the handset	8	phone settings	16
Customer helpline	45	remote access	30
Day and time setting	22	Outgoing message	
Dial mode	17	playing	22, 25
Directory label	13	recording	23
Emergency calls	41	Pause	26, 28
Handset range	12	Phone socket	6
Help	41	Power cable	7

Range	12
Recall	34
Recall mode	17
Receiving calls	12
Redial	13
Remote operation	30
Ringer equivalence number (REN)	47
Ringer on/off at the handset	16
Ringer volume at the base unit	16
Secrecy button	18
Security code	25
Service	45
Setting up	5
Skip message	27
Switchboard	37
Talk button	12
Technical information	46
Time saver	23
Wall-mounting	10

Freestyle 1500 Plus



*Offices in Europe, North America,
Japan and Asia Pacific.*

The telecommunications services described in this publication are subject to availability and may be modified from time to time. Services and equipment are provided subject to British Telecommunications plc's respective standard conditions of contract. Nothing in this publication forms any part of any contract.

Touchtone[™] is a registered trade mark of British Telecommunications plc in the UK.

© British Telecommunications plc 1997.
Registered Office: 81 Newgate Street, London EC1A 7AJ.
Registered in England No. 1800000.
Printed in Thailand. Freestyle 1500 Plus Issue 1 (11/97).
Designed by The Art & Design Partnership Limited.



CE compliant to 89/336/EEC
(EMC Directive) & 73/23/EEC (Low
Voltage Directive)

APPROVED for connection to
telecommunication systems specified
in the instructions for use subject to
the conditions set out in them

503986